



AUGUST 2021

TECHNICAL MEMO

EXISTING AND FUTURE NO-BUILD CONDITIONS



1.0 INTRODUCTION

US 29 serves as a gateway between Greene and Albemarle Counties and as a National Highway System route facilitating regional, state, and interstate travel. As development changes the character and travel demand along US 29, investments are needed to ensure the continued safe and comfortable travel for all roadway users. The Virginia Department of Transportation (VDOT) is using the public engagement process and analyzing present conditions and future plans to develop a series of feasible transportation options for an approximately six-mile section of Seminole Trail (US 29) as it runs through Greene and Albemarle County.

The Corridor

The study corridor includes US 29 between Deerfield Drive in Greene County and Airport Road in Albemarle County (**Figure 1**). VDOT classifies US 29 as a principal arterial throughout the state and falls within the National Highway System (NHS). US 29 serves as one of three NHS roadways in the Charlottesville vicinity, running north-south between the Commonwealth's two major north-south interstates: I-81 and I-95. Long-term traffic volumes are projected to grow along US 29 due to planned developments and associated population growth.

The Study

Through the US 29 corridor study, VDOT will engage Greene County, Albemarle County, and other stakeholders to evaluate automobile, transit, bicycle, and pedestrian travel conditions along the US 29 corridor. The study will assess future travel projections and development patterns and identify

KEY TERMS>>

- **Principal Arterial:** In urban areas, these roads serve the major activity centers of a metropolitan area and provide continuity for major rural corridors to accommodate trips entering and leaving an urban area.
- **Minor Arterial:** These roads include all arterials not classified as principal arterials, provide more land access than principal arterials, and connect lower speed, lower volume roadways with higher speed, higher volume principal arterials.
- **Major Collector:** Major collectors provide land access and traffic circulation within residential neighborhoods, commercial, and industrial areas. They connect traffic from local roads with the arterial system.
- **National Highway System (NHS):** This is the network of strategic highways within the United States that serves major airports, ports, rail or truck terminals, railway stations, pipeline terminals, or other strategic transport facilities.

transportation solutions to help meet the study's vision and goals.

The study vision for US 29 is to provide safe travel and adequate capacity for all uses and users of the roadway. The study goals include:

1. **Improve safety and comfort**
2. **Manage congestion**
3. **Increase multimodal usability and accessibility**
4. **Support future growth**
5. **Support economic development**

Study Stakeholders

This study is supported by a stakeholder group made up of representatives from the Albemarle County, Greene County, the Thomas Jefferson Planning District Commission (TJPD), Charlottesville Area Transit (CAT), and Jaunt.

Public Engagement

The community is being engaged throughout the project through online surveys, the project website, and a series of public meetings. VDOT and TJPDC has reached out to the following community groups and neighborhood organizations:

- Charlottesville-Albemarle Airport
- Hollymead Town Center
- National Ground Intelligence Center (NGIC)
- University of Virginia (UVA) Research Park

This Memorandum

This document discusses existing and future 2045 no-build conditions along the full length of the corridor through a variety of sources, including land use data, transportation data, transit ridership information, and crash history. The data are complemented by input received from stakeholders, key community groups, and members of the public through meetings and surveys. The information from the data analysis and stakeholder input will inform the measures that will be used to evaluate alternative solutions later in the study process.

Figure 1 US 29 Study Corridor Map

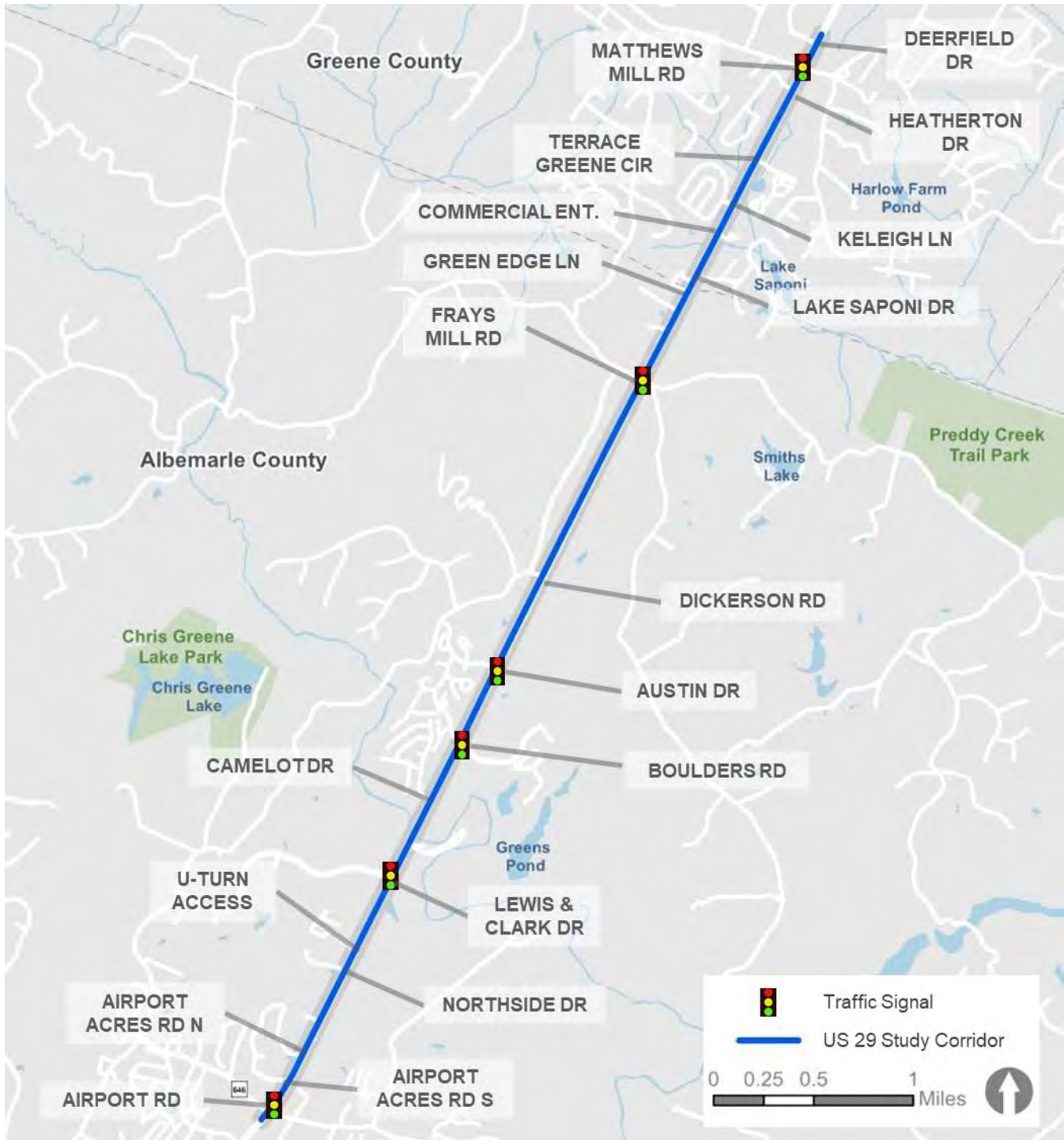

Source: Kittelson 2021

2.0 LAND USE CONTEXT

This section summarizes the approach and findings of the land use context analysis. The material below discusses existing land use patterns and future land use trends along the study corridor.

2.1 Existing Land Use

The US 29 corridor is a diverse area that serves as the gateway between Greene and Albemarle Counties and the surrounding region. US 29 serves an important role as an east-coast US highway, connecting regional residents, commuters, and travelers alike to statewide destinations like Northern Virginia, Charlottesville, and Danville, and out-of-state destinations like Maryland or Florida. Major activity centers along the corridor include University of Virginia Research Park, Charlottesville-Albemarle Airport, Hollymead Town Center, and National Ground Intelligence Center. Important activity centers near the study area include Greene Lake State Park and Preddy Creek Trail Park.

Figure 2 summarizes existing land uses along the corridor.

Existing Land Use Data

2019 parcel-level zoning data were obtained from Albemarle County and Greene County. These data include each parcel's land use code.

Existing Land Use

The land use mixes along US 29 contributes greatly to the corridor's character. Traveling along US 29 from the study corridor's northern terminus

at Deerfield Drive to its southern terminus at Airport Road, it is possible to observe a range of land use contexts. Rural landscape, residential neighborhoods, industrial parks, and numerous planned developments to come can be found along the length of the corridor.

The US 29 corridor comprises a mix of land uses, with much of the larger surrounding area dedicated to rural land uses. North of the Albemarle-Greene County line, land is primarily zoned residential and highway commercial. South of the county line in Albemarle County, land is mainly rural until Austin Drive. Residential zoning is concentrated on the west side of US 29 from Austin Drive to the Rivanna River, while a mix of industrial, commercial, and planned residential zoning exists on the east side. Much of the area south of the Rivanna River is reversed from its zoning to the north, with industrial and planned industrial zoning on the west side of US 29. Planned mixed-use zoning is located south of the Rivanna River on the east side of US 29.

Two informal boundaries exist along the corridor – one being the Albemarle-Greene County line, separating rural uses to the south from residential and commercial to the north – and the other being the Rivanna River, separating rural uses to the north from the denser development to the south.

Activity Generators

Figure 3 shows various activity generators along US 29. These include:

- Schools: University of Virginia (UVA) Research Park
- Transportation: Charlottesville-Albemarle Airport
- Shopping destinations: Hollymead Town Center (south of study area)
- Government institutions: National Ground Intelligence Center (NGIC)

Figure 2 Existing Land Use

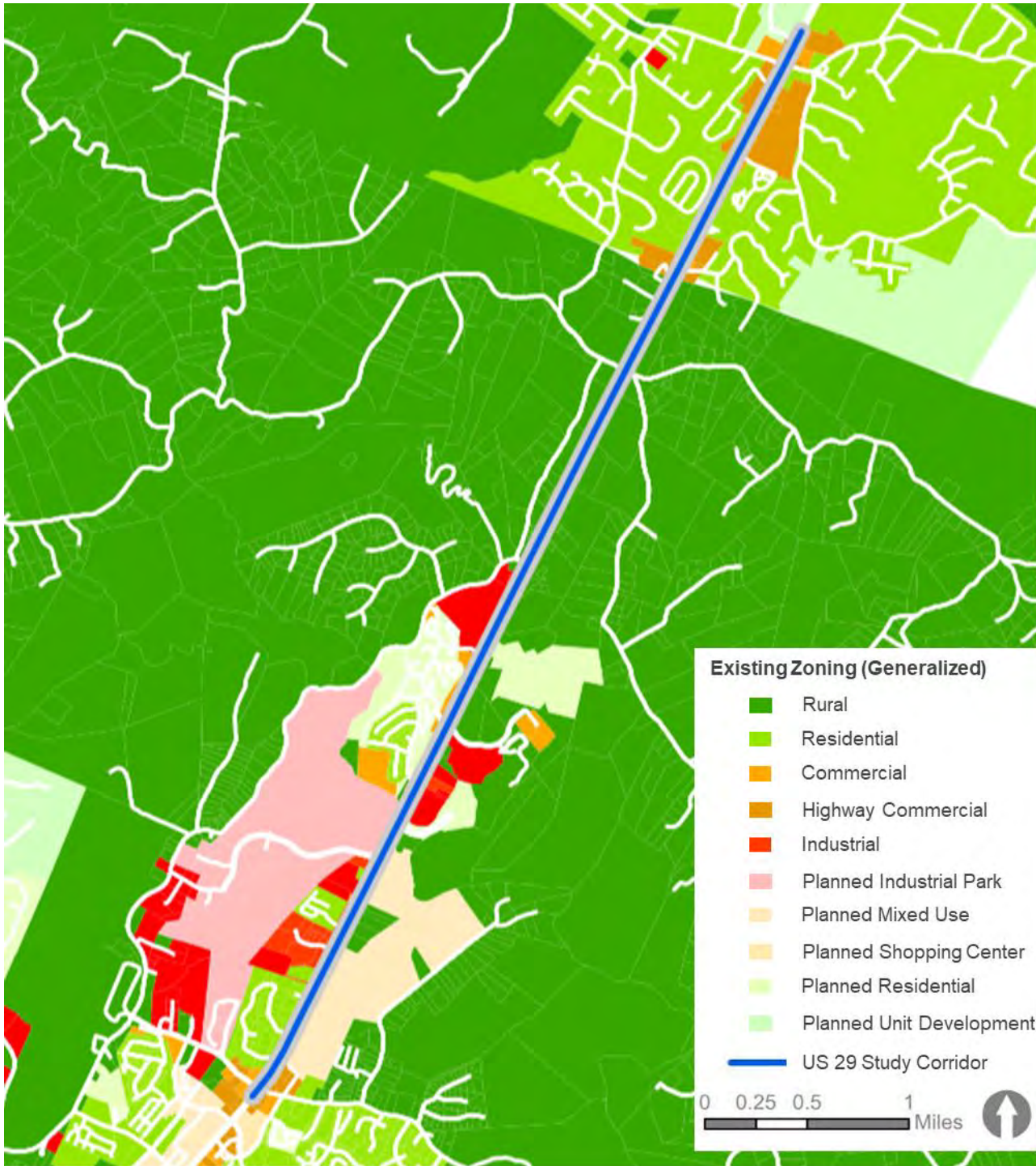

Source: Albemarle County, Greene County, Kittelson 2021

Figure 3 Activity Generators

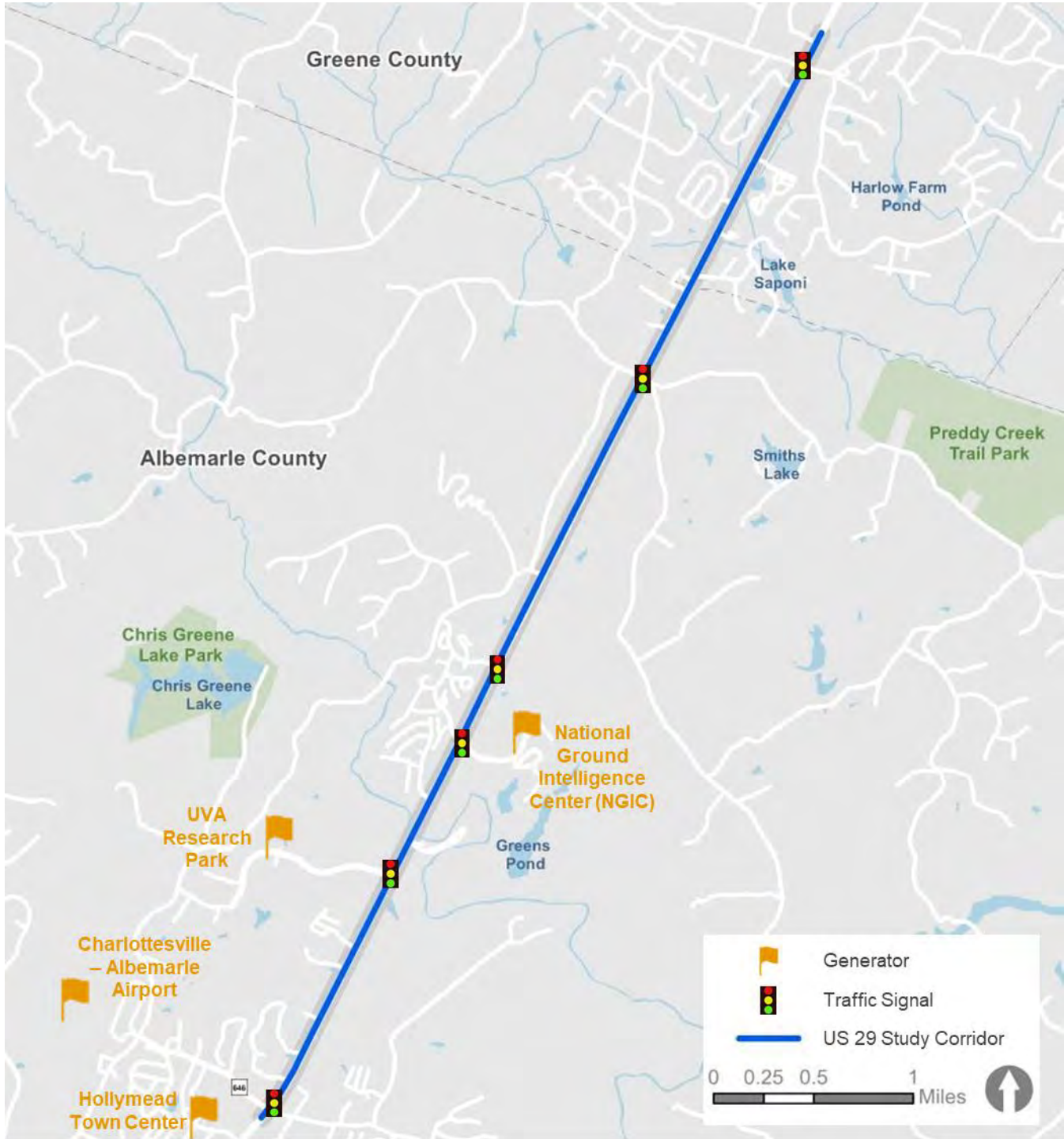

Source: Kittelson 2021

2.2 Future Land Use

As a significant highway for regional, statewide, and national travel, the number of roadway improvement and development projects along US 29 have been trending upward. **Figure 4** identifies the different planned developments bringing diverse land uses to the corridor.

Future Land Use Data

Future land use data were obtained from members of the study stakeholder group, including Albemarle and Greene Counties. These data included planned future developments located within the study corridor.

Future Land Use

Figure 4 shows the current planned developments for each of the municipalities along the corridor. Within the corridor, six residential-based, mixed-use developments are slated for construction or actively participating in Albemarle and Greene County's development approval processes in the vicinity of US 29. These developments include:

- Village at Terrace Greene
- Cedar Run Townhomes
- Seminole Casa
- Creekside & The Village at Preddy Creek
- Judo Townhomes
- North Pointe

Village at Terrace Greene (Greene)

The Village at Terrace Greene development is actively participating in Greene County's development approval process, so the land use mix proposed by the development is in flux. The proposed development site connects Route 670 to US 29 and sits on the east side of the corridor with

site access from Terrace Greene Circle, Route 670, Heatherton Drive, and a new site access driveway north of Terrace Greene Circle. The latest known proposal for the Village at Terrace Greene site includes:

- 282 townhomes, a movie theater, a day care, industrial space, and several retail uses.

Cedar Run Townhomes (Greene)

The Cedar Run Townhomes development is actively participating in Greene County's development approval process. The proposed development site includes a site access to US 29 north of Keleigh Lane and sits west of the corridor. The latest known proposal for the Village at Terrace Greene site includes:

- 55 townhomes.

Seminole Casa (Greene)

The Seminole Casa development is actively participating in Greene County's development approval process. The proposed development site sits west of US 29 between Keleigh Lane and Lake Saponi Drive. The latest known proposal for Seminole Casa includes:

- 120 apartments.

Judo Townhomes (Greene)

The Judo Townhomes development is actively participating in Greene County's development approval process and is under review. The proposed development site sits east of US 29 off Judo Drive. The latest known proposal for the Judo Townhomes site includes:

- 165 townhomes.

Creekside & The Village at Preddy Creek (Greene)

Creekside & The Village at Preddy Creek development is actively participating in Greene County’s development approval process. The proposed development sits east of US 29 with site access off Route 670 near Preddy Creek Trail Park. The latest known proposal for Creekside & The Village at Preddy Creek site includes:

- 580 townhomes and 600 single family homes.

North Pointe (Albemarle)

The North Pointe development is broken into multiple phases and is actively participating in Albemarle County’s development approval process, so the land use mix proposed by the development is in flux. The proposed development site sits east of US 29 includes 2 site accesses to the corridor – one across from Northside Drive and one across from Lewis and Clark Drive. The latest known proposal for the Village at Terrace Greene site includes:

- 205 single family homes in Phase I,
- An addition of 300 apartment units in the full build.

Future Roadway Projects

Figure 5 shows the current planned roadway projects along the corridor that are approved and funded. These projects include:

- Route 670 Connector
- Lewis & Clark Drive Restricted Crossing U-Turn (RCUT)

Route 670 Connector

The Route 670 Connector will be a two-lane road connecting Route 670 to US 29 which is expected

to be constructed by 2025. The proposed Route 670 Connector Road includes:

- Constructing a new median break as a directional crossover
- Constructing a northbound right-turn lane on US 29 with 450 feet of storage
- Constructing a southbound left-turn lane on US 29 with 450 feet of storage.

Lewis & Clark Drive RCUT

An RCUT is proposed at the intersection of US 29/Lewis & Clark Drive with a new site access proposed for the North Pointe development opposite to Lewis & Clark Drive. The intersection is proposed to be reconfigured as a signalized RCUT by North Pointe’s full-build analysis year of 2026.

Figure 4 Planned Developments on US 29

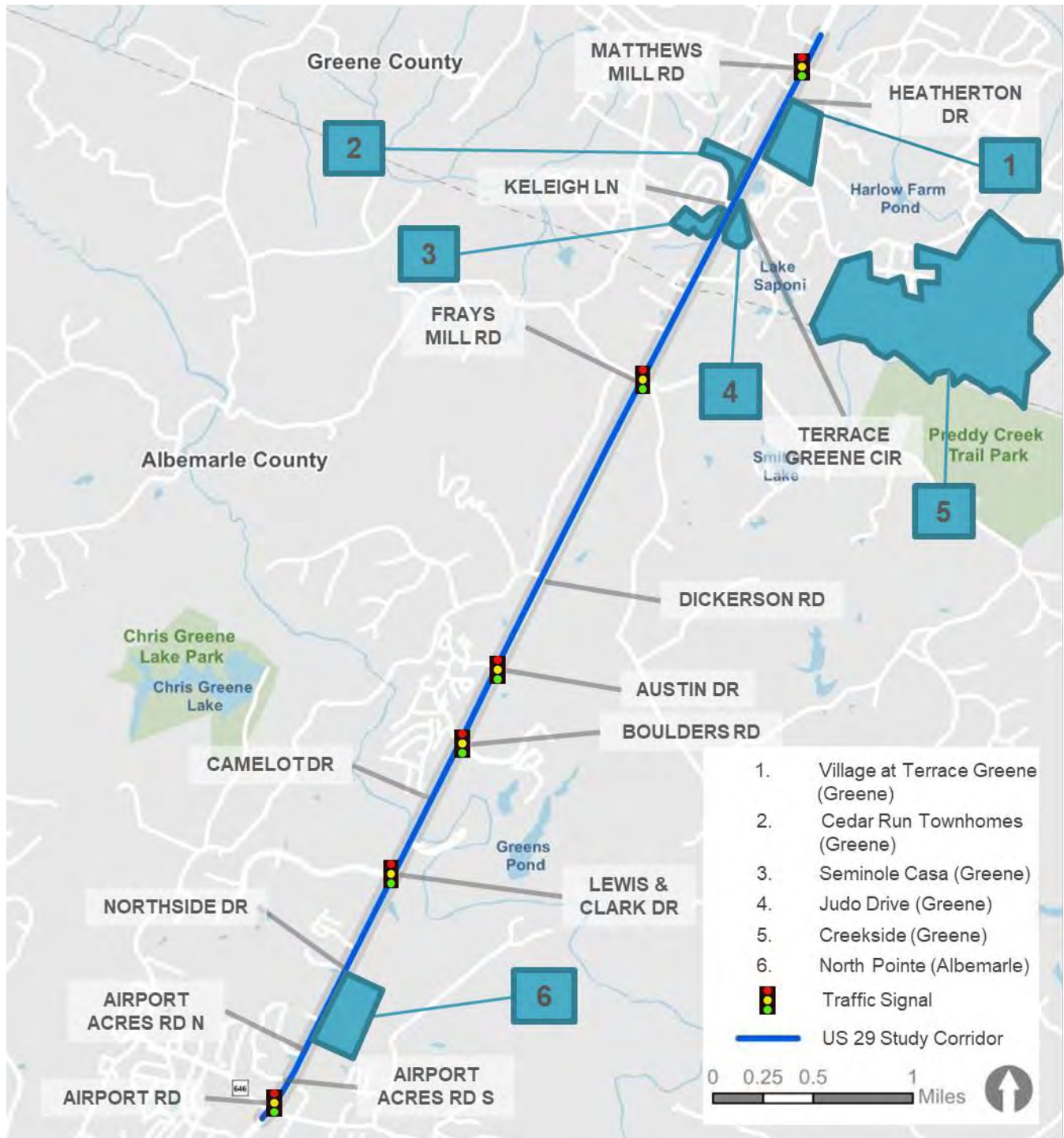

Source: Albemarle County, Greene County, Kittelson 2021.

Figure 5 Planned Roadway Developments on US 29

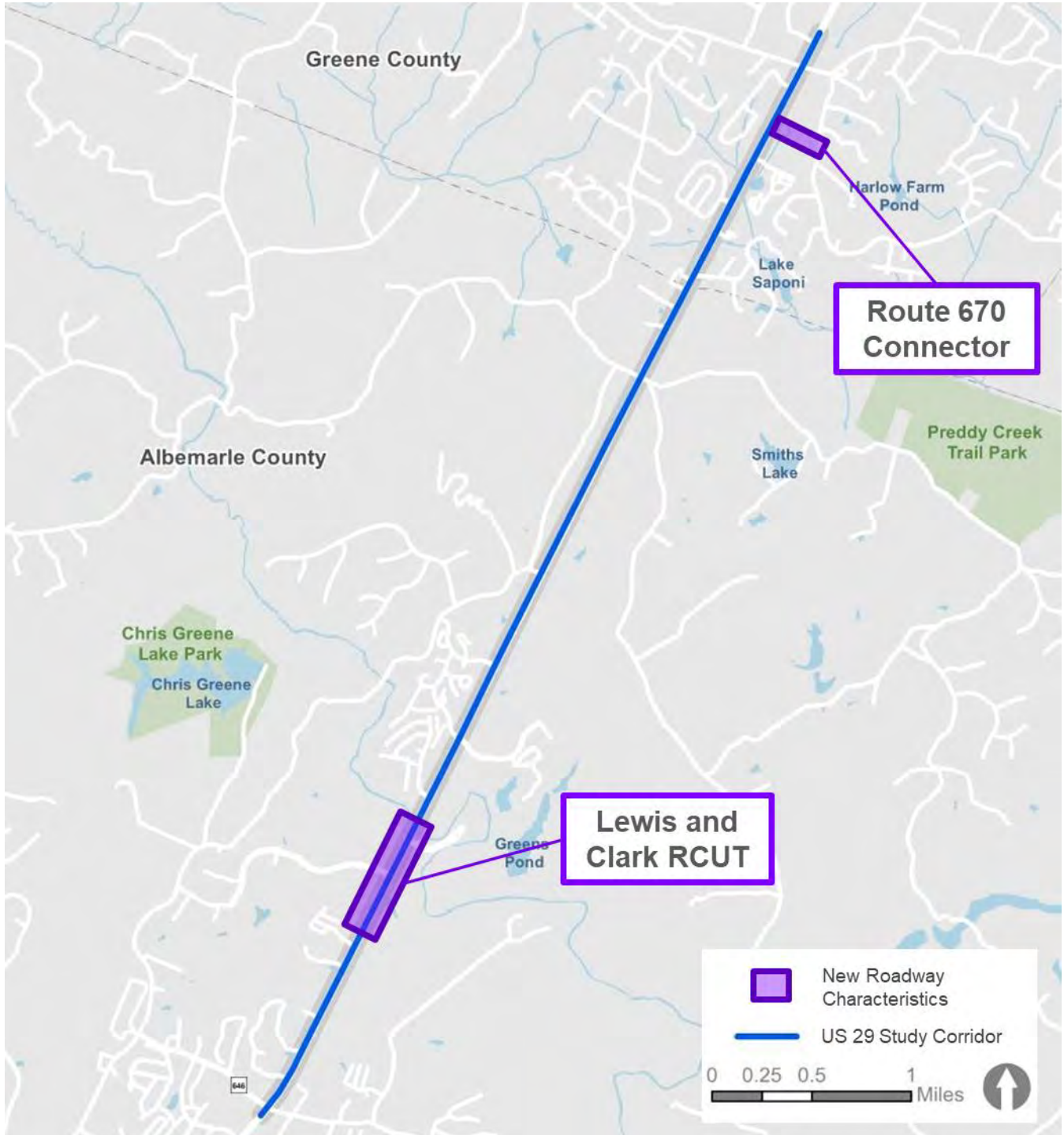

Source: Kittelson 2021.

3.0 INTERSECTION OPERATIONS

This section summarizes the approach and findings for traffic operations analysis under existing and future year 2045 no-build conditions. **Table 1** displays the major transportation facilities for this study.

Table 1 Major Roadway Facilities

Roadway	US 29		
	Deerfield Dr to Albemarle Co. Line	Greene Co. Line to Camelot Dr	Camelot Dr to Airport Rd
Classification ¹	Principal Arterial	Principal Arterial	Principal Collector
Number of Lanes	4	4	4
Speed Limit (mph)	55	55	45-55 ²
Average Annual Daily Traffic ³	24,000	27,000	32,000
Median	Yes	Yes	Yes
Sidewalks	No	No	No
Bicycle Lanes	No	No	No
On-Street Parking	No	No	No

¹ Classifications based on VDOT's 2014 Functional Classification Map.
² US 29 is only 45 mph between Airport Acres Road (S) and Airport Road.
³ Average Annual Daily Traffic (AADT) based on VDOT's Virginia Roads Traffic Volume Map

3.1 Existing Conditions

A mixture of previous studies and data collection was used to produce traffic counts. While most traffic counts were collected in April 2021, six intersections had 2017 and 2020 volumes pulled from previous studies Village at Terrace Greene TIA and US 29 & Route 641 Study, respectively. Weekday a.m. and p.m. data were gathered for 19 study intersections along the street:

KEY TERMS>>

- **Operations Analysis:** An evaluation of how a roadway or set of roadways function under existing and/or anticipated traffic and geometric conditions.
- **Peak Hour:** The time of day when demand for a transportation facility is highest and the ease with which vehicles can move through the transportation facility is most limited. Weekdays typically have two peak hours (AM and PM), while weekends have a single peak hour.

- Deerfield Drive
- Matthew Mill Road (signalized)
- Heatherton Drive
- Terrace Greene Circle
- Keleigh Lane
- Commercial Entrance
- Lake Saponi Drive
- Green Edge Lane
- Frays Mill Road (signalized)
- Dickerson Road
- Austin Drive (signalized)
- Boulders Road (signalized)
- Camelot Drive
- Lewis & Clark Drive (signalized)
- U-Turn Access north of Cypress Drive
- Northside Drive
- Airport Acres Road N
- Airport Acres Road S
- Airport Road (signalized)

Figure 6 shows the traffic count locations.

Intersection-specific peak hours were used for the analysis given the distances between intersection and the mix of land uses/contexts throughout the corridor. AM peak hours were observed to occur between 7:15 a.m. and 8:45 a.m. PM peak hours

were observed to occur between 4:00 p.m. and 6:00 p.m.

Traffic operations analyses were performed at study corridor intersections in accordance with the *Highway Capacity Manual (HCM)* using SYNCHRO 10. Due to non-National Electrical Manufacturers Association (NEMA) phasing limitations, HCM 2000 was used. **Table 2** and **Figure 7** as well as **Table 3** and **Figure 8** summarize the operational analysis for the study intersections under the weekday a.m. and p.m. peak hour existing traffic conditions, respectively. The traffic counts can be found in **Attachment A**. The full analysis can be found in **Attachment B**.

Most of the study intersections perform acceptably during each of the peak hours studied. Exceptions are described below:

AM Existing Conditions

- Most LOS E and F movements are due to delay and are not near capacity.
- Heavy southbound through traffic
- Two intersections over capacity as measured by volume-to-capacity (v/c) ratio:
 - US 29/Frays Mill Rd over capacity: $v/c = 1.32$
 - US 29/Airport Rd over capacity: $v/c = 1.02$

PM Existing Conditions

- Most LOS E and F movements are due to delay and are not near capacity.
- One intersection over capacity:
 - US 29/Airport Rd over capacity: $v/c = 1.05$

KEY TERMS>>

- **Delay:** The amount of time it takes vehicles to pass through an intersection (reported in seconds)
- **Level of Service (LOS):** A performance metric communicating quality of intersection service. For vehicles, LOS D indicates acceptable quality in urban conditions, while LOS scores of E-F indicate poor quality.
- **Volume-to-capacity (v/c) ratio:** A ratio comparing the number of vehicles traveling through an intersection at a given point in time to the maximum capacity of the intersection. A v/c score of 1 or higher means that an intersection is at or above capacity. A v/c score below 1 means that an intersection is below capacity.
- **95th percentile queue length:** The worst-case queue length (number of vehicles waiting in a lane) during a given time period. These queues have only a 5 percent probability of being exceeded.

Figure 6 US 29 Traffic Count Locations

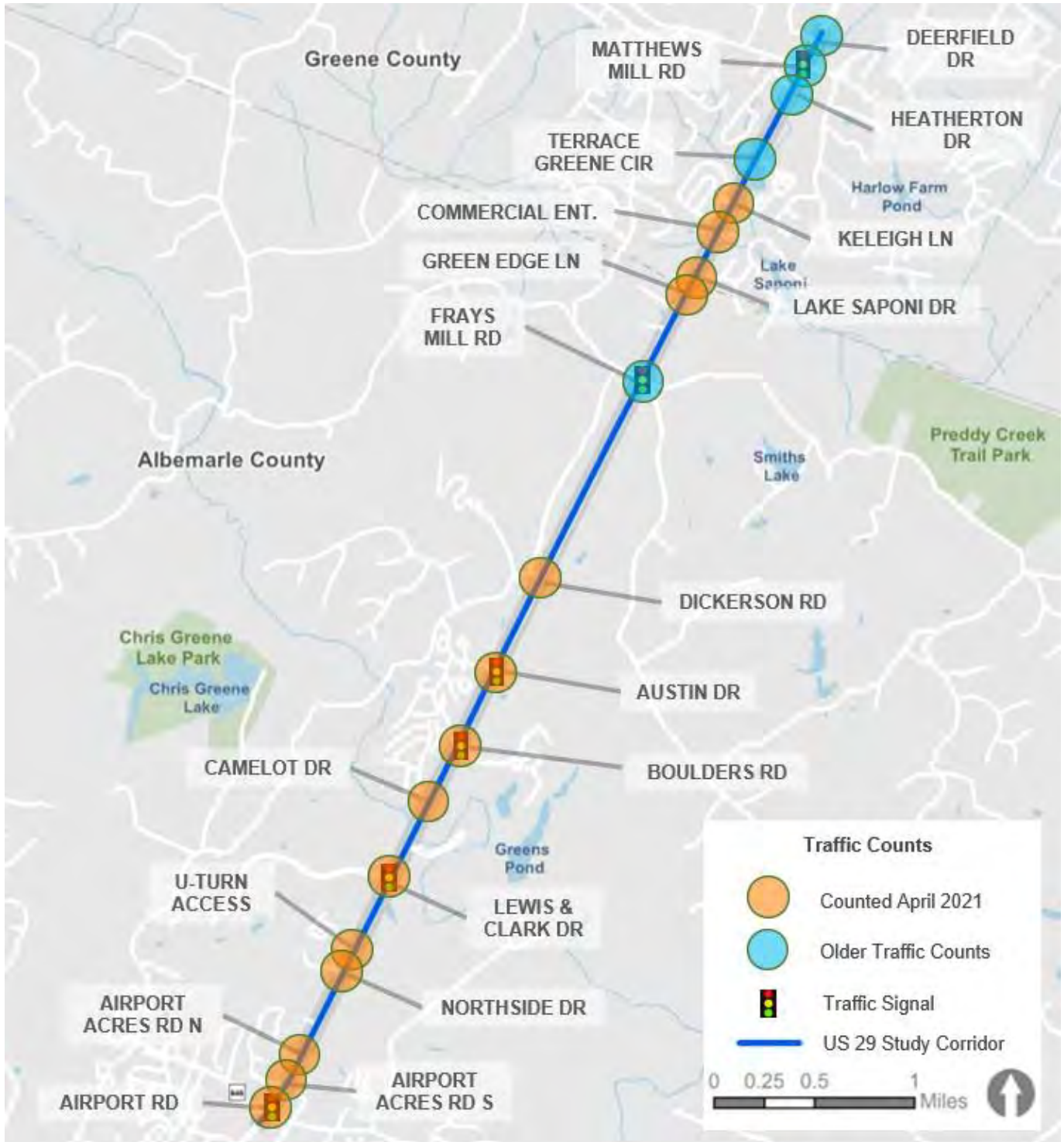

Older traffic counts include: 2018 US 29/Route 641 Corridor Study and 2017 Terrace Greene TIA.
 Source: Kittelson 2021

Table 2 Existing AM Conditions Operational Analysis

Intersection	Peak hour	Intersection delay (sec) and level of service ¹	Worst-performing movement	Delay (sec) and level of service ²	v/c ²	95 th percentile queues (feet) ³
US 29/Deerfield Drive	AM Peak		Deerfield Drive (EB)	21.6 (C)	0.43	8
US 29/Matthew Mill Road	AM Peak	49.2 (D)	US 29 (SB)	58.5 (E)	0.90	#744
US 29/Heatherton Drive	AM Peak		Heatherton Drive (EB)	17.9 (C)	0.56	17
US 29/Terrace Greene Circle	AM Peak		Terrace Greene Circle (EB)	17.9 (C)	0.53	11
US 29/Keleigh Lane	AM Peak		Keleigh Lane (EB)	35.1 (E)	0.58	29
US 29/Commercial Entrance	AM Peak		Commercial Entrance (WB)	33.4 (D)	0.57	39
US 29/Lake Saponi Drive	AM Peak		Lake Saponi Drive (WB)	10.6 (B)	0.60	5
US 29/Greene Edge Lane	AM Peak		Greene Edge Lane (EB)	20.8 (C)	0.82	0
US 29/Frays Mill Road	AM Peak	128.4 (F)	Frays Mill Road (WB)	1126.4 (F)	1.32	#1174
US 29/Dickerson Road	AM Peak		Dickerson Road (EB)	64.3 (F)	0.65	28
US 29/Austin Drive	AM Peak	12.1 (B)	Austin Drive (EB)	51.0 (D)	0.86	#925
US 29/Boulders Road	AM Peak	29.2 (C)	Boulders Road (WB)	51.5 (D)	0.83	#1009
US 29/Camelot Drive	AM Peak		Camelot Drive (EB)	50.5 (F)	0.66	41
US 29/Lewis & Clark Drive	AM Peak	11.3 (B)	Lewis & Clark Drive (EB)	52.0 (D)	0.77	#815
US 29/U-Turn Access	AM Peak		U-Turn Access (WB)	23.1 (C)	0.63	6
US 29/Northside Drive	AM Peak		Northside Drive (WB)	99.7 (F)	0.65	7
US 29/Airport Acres Road N	AM Peak		Airport Acres Road North (WB)	96.7 (F)	0.89	2
US 29/Airport Acres Road S	AM Peak		Airport Acres Road South (EB)	26.9 (E)	0.88	5
US 29/Airport Road	AM Peak	46.4 (D)	Airport Road (WB)	164.8 (F)	1.02	#826

¹ Average intersection delay, LOS reported only for signalized intersections

² Reported delay, level of service, v/c, and 95th percentile queues represent the worst-performing metric at each intersection

³ 95th percentile queues rounded up to the nearest whole number

Table 3 Existing PM Conditions Operational Analysis

Intersection	Peak hour	Intersection delay (sec) and level of service ¹	Worst-performing movement	Delay (sec) and level of service ²	v/c ²	95 th percentile queues (feet) ³
US 29/Deerfield Drive	PM Peak		Deerfield Drive (EB)	18.9 (C)	0.44	18
US 29/Matthew Mill Road	PM Peak	37.5 (D)	Matthew Mill Road (EB)	59.6 (E)	0.81	#249
US 29/Heatherton Drive	PM Peak		Heatherton Drive (EB)	14.1 (B)	0.56	6
US 29/Terrace Greene Circle	PM Peak		Terrace Greene Circle (WB)	25.3 (D)	0.59	25
US 29/Keleigh Lane	PM Peak		Keleigh Lane (EB)	18.1 (C)	0.61	6
US 29/Commercial Entrance	PM Peak		Commercial Entrance (WB)	25.8 (D)	0.59	23
US 29/Lake Saponi Drive	PM Peak		Lake Saponi Drive (WB)	23.6 (C)	0.59	14
US 29/Greene Edge Lane	PM Peak		Greene Edge Lane (EB)	0.0 (A)	0.80	0
US 29/Frays Mill Road	PM Peak	31.5 (C)	Frays Mill Road (WB)	78.9 (E)	0.87	#1021
US 29/Dickerson Road	PM Peak		Dickerson Road (EB)	28.9 (D)	0.87	17
US 29/Austin Drive	PM Peak	7.0 (A)	Austin Drive (EB)	56.3 (E)	0.84	435
US 29/Boulders Road	PM Peak	26.8 (C)	Boulders Road (WB)	64.8 (E)	0.86	#1029
US 29/Camelot Drive	PM Peak		Camelot Drive (WB)	139.1 (F)	0.68	49
US 29/Lewis & Clark Drive	PM Peak	13.0 (B)	Lewis & Clark Drive (EB)	54.3 (D)	0.82	627
US 29/U-Turn Access	PM Peak		U-Turn Access (WB)	15.1 (C)	0.41	4
US 29/Northside Drive	PM Peak		Northside Drive (WB)	30.0 (D)	0.40	8
US 29/Airport Acres Road N	PM Peak		Airport Acres Road North (WB)	32.2 (D)	0.55	4
US 29/Airport Acres Road S	PM Peak		Airport Acres Road South (EB)	15.7 (C)	0.63	3
US 29/Airport Road	PM Peak	65.2 (E)	US 29 (NB)	88.7 (F)	1.05	#1130

¹ Average intersection delay, LOS reported only for signalized intersections

² Reported delay, level of service, v/c, and 95th percentile queues represent the worst-performing metric at each intersection

³ 95th percentile queues rounded up to the nearest whole number

Figure 7 Existing AM Conditions Operational Analysis

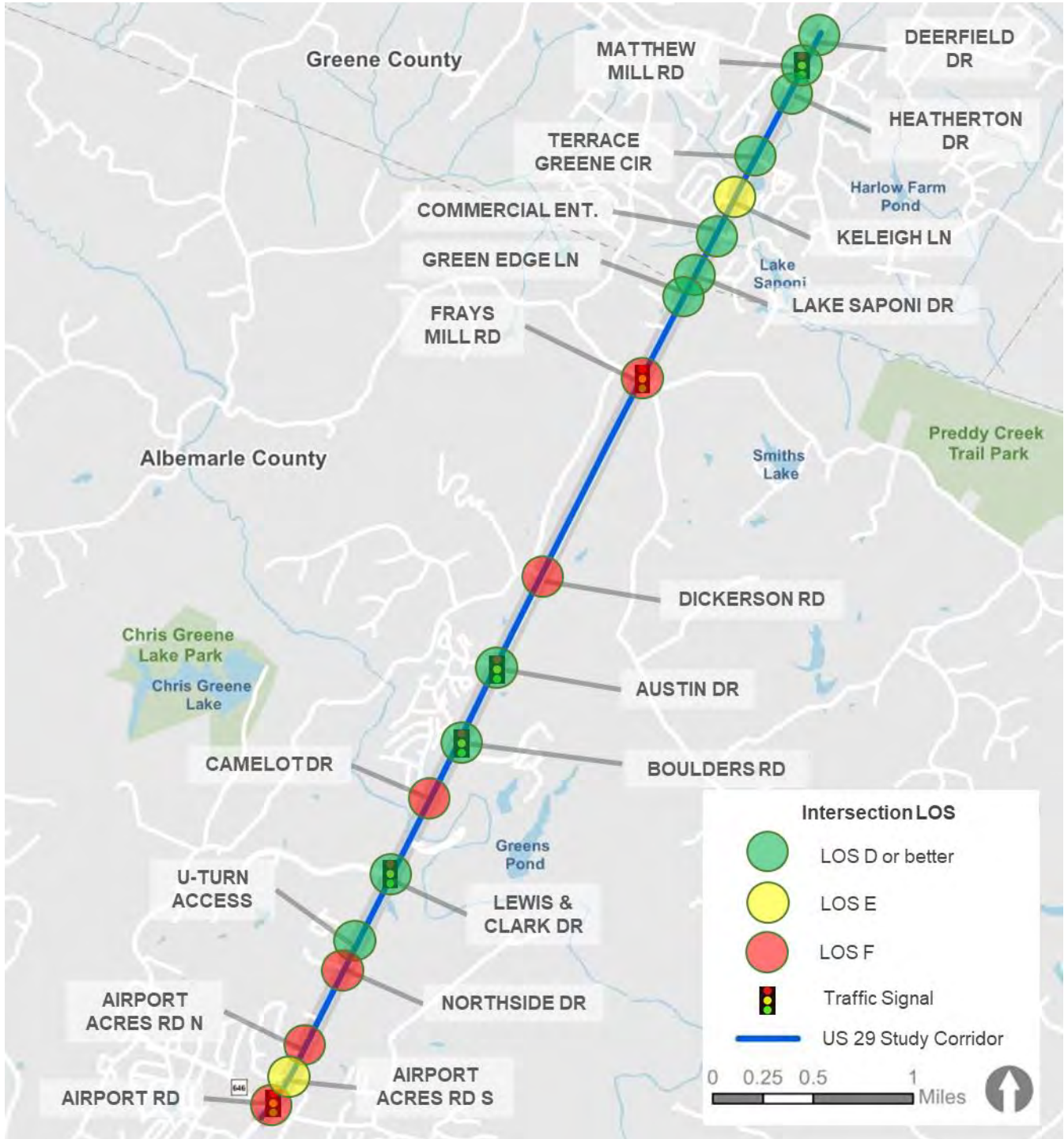

Note: All unsignalized intersections are displaying the worst, critical movement.
 Source: Kittelson 2021.

Figure 8 Existing PM Conditions Operational Analysis

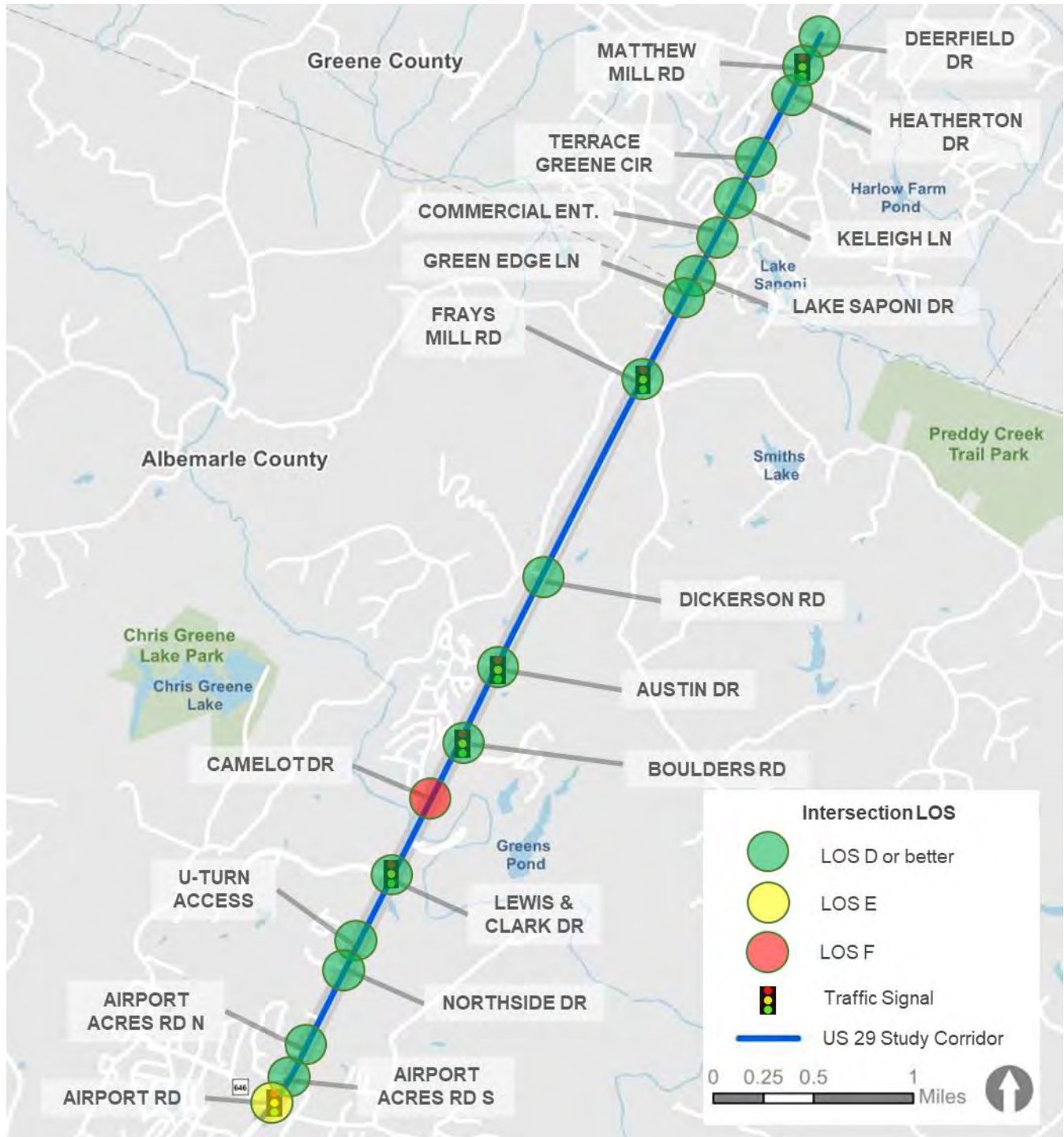

Note: All unsignalized intersections are displaying the worst, critical movement.
 Source: Kittelson 2021.

3.2 Future No-Build Conditions

In addition to considering existing traffic operations, VDOT analyzed future traffic operations at the study corridor intersections. VDOT identified a future design year and growth rates through which they could estimate and assess the influence of increased traffic volumes on the study intersections. The growth rates were pulled from Statewide Planning System historic growth graphs and determined to be a more accurate forecast than pulling site traffic from surrounding developments.

The future operations analysis assumed a design year of 2045, future background traffic volume annual growth varies throughout the corridor:

- US 33 to Greene Co. Line: 0.63%
- Greene Co. Line to Dickerson Rd: 0.65%
- Dickerson Rd to Camelot Rd: 0.64%
- Lewis & Clark Dr to Airport Rd: 0.88%
- South of Airport Rd: 1.24%

The analysis assumed new driveways at three intersections providing an estimate of how the existing transportation network could operate in a “no build” scenario:

- Village at Terrace Greene Access (east) at US 29/Heatherton Drive
- North Pointe Access 1 at US 29/Northside Drive
- North Pointe Access 2 at US 29/Lewis & Clark Drive

Traffic operations analyses were performed at study corridor intersections in accordance with the *Highway Capacity Manual (HCM)* using SYNCHRO 10. Due to non-NEMA phasing limitations, HCM 2000 was used. **Table 4** and **Figure 9** as well as

KEY TERMS>>

- **Design Year:** Future year used to assess how existing traffic volumes will grow and influence a transportation network
- **Growth Rate:** Rate of growth applied to existing traffic counts to estimate how traffic volumes could increase in the future

Table 5 and **Figure 10** summarize the operational analysis for the study intersections under the weekday a.m. and p.m. peak hour future no-build traffic conditions. The full analysis can be found in **Attachment C**.

Some of the intersections studied are forecast to perform acceptably during each of the peak hours studied with exceptions described below:

AM Future Conditions

- Eight intersections operating at LOS E or F
- Four intersections at or over capacity
 - US 29/Frays Mill Road
 - US 29/Austin Drive
 - US 29/Airport Acres Road N
 - US 29/Airport Road

PM Future Conditions

- Six intersections operating at LOS E or F
- Five intersections at or over capacity
 - US 29/Dickerson Road
 - US 29/Boulders Road
 - US 29/Camelot Drive
 - US 29/Lewis & Clark U-Turn S
 - US 29/Airport Road

Table 4 Future No-Build AM Conditions Operational Analysis

Intersection	Peak hour	Intersection delay (sec) and level of service ¹	Worst-performing movement	Delay (sec) and level of service ²	v/c ²	95 th percentile queues (feet) ³
US 29/Deerfield Drive	AM Peak		Deerfield Drive (EB)	26.8 (D)	0.49	12
US 29/Matthew Mill Road	AM Peak	26.3 (E)	Matthew Mill Road (WB)	83.1 (F)	0.94	#733
US 29/Heatherston Drive	AM Peak	4.8 (A)	Heatherston Drive (EB)	51.3 (D)	0.71	m92
US 29/Terrace Greene Circle	AM Peak		Terrace Greene Circle (EB)	25.5 (D)	0.61	13
US 29/Keleigh Lane	AM Peak		Keleigh Lane (EB)	35.1 (E)	0.58	29
US 29/Commercial Entrance	AM Peak		Commercial Entrance (WB)	33.4 (D)	0.57	39
US 29/Lake Saponi Drive	AM Peak		Lake Saponi Drive (WB)	11.1 (B)	0.69	6
US 29/Greene Edge Lane	AM Peak		Greene Edge Lane (EB)	25.5 (D)	0.71	0
US 29/Frays Mill Road	AM Peak	388.9 (F)	Frays Mill Road (WB)	1061.9 (F)	2.28	#1707
US 29/Dickerson Road	AM Peak		Dickerson Road (EB)	158.8 (F)	0.76	61
US 29/Austin Drive	AM Peak	26.9 (C)	Austin Drive (EB)	51.0 (D)	1.00	m566
US 29/Boulders Road	AM Peak	51.1 (D)	Boulders Road (WB)	51.8 (D)	0.97	#1193
US 29/Camelot Drive	AM Peak		Camelot Drive (EB)	115.1 (F)	0.76	84
US 29/Lewis & Clark U-Turn N	AM Peak	18.4 (B)	Lewis & Clark U-Turn N (WB)	53.4 (D)	0.93	#1247
US 29/Lewis & Clark Drive	AM Peak	5.7 (A)	Lewis & Clark Drive (EB)	47.7 (D)	0.86	#1132
US 29/Lewis & Clark U-Turn S	AM Peak	2.4 (A)	Lewis & Clark U-Turn S (EB)	51.8 (D)	0.41	71
US 29/U-Turn Access	AM Peak	4.2 (A)	U-Turn Access (WB)	61.9 (E)	0.84	308
US 29/Northside Drive	AM Peak	9.6 (A)	Northside Drive (WB)	117.1 (F)	0.42	127
US 29/Airport Acres Road N	AM Peak		Airport Acres Road North (WB)	197.2 (F)	1.08	4
US 29/Airport Acres Road S	AM Peak		Airport Acres Road South (EB)	61.4 (F)	0.54	12
US 29/Airport Road	AM Peak	84.0 (F)	Airport Road (WB)	251.5 (F)	1.23	#1132

¹ Average intersection delay, LOS reported only for signalized intersections

² Reported delay, LOS, v/c, and 95th percentile queues represent the worst-performing metric at each intersection

³ 95th percentile queues rounded up to the nearest whole number

Table 5 Future No-Build PM Conditions Operational Analysis

Intersection	Peak hour	Intersection delay (sec) and level of service ¹	Worst-performing movement	Delay (sec) and level of service ²	v/c ²	95 th percentile queues (feet) ³
US 29/Deerfield Drive	PM Peak		Deerfield Drive (EB)	23.9 (C)	0.51	29
US 29/Matthew Mill Road	PM Peak	44.3 (D)	Matthew Mill Road (EB)	70.4 (E)	0.89	#240
US 29/Heatherton Drive	PM Peak	4.3 (A)	Heatherton Drive (EB)	26.9 (E)	0.65	m302
US 29/Terrace Greene Circle	PM Peak		Terrace Greene Circle (WB)	35.7 (E)	0.69	42
US 29/Keleigh Lane	PM Peak		Keleigh Lane (EB)	18.1 (C)	0.61	6
US 29/Commercial Entrance	PM Peak		Commercial Entrance (WB)	25.8 (D)	0.59	23
US 29/Lake Saponi Drive	PM Peak		Lake Saponi Drive (WB)	29.9 (D)	0.69	22
US 29/Greene Edge Lane	PM Peak		Greene Edge Lane (EB)	0.0 (A)	0.80	0
US 29/Frays Mill Road	PM Peak	68.5 (E)	Frays Mill Road (WB)	148.4 (F)	1.03	#1267
US 29/Dickerson Road	PM Peak		Dickerson Road (EB)	40.6 (E)	1.02	29
US 29/Austin Drive	PM Peak	10.3 (B)	Austin Drive (EB)	54.8 (D)	0.98	m457
US 29/Boulders Road	PM Peak	50.3 (D)	Boulders Road (WB)	95.6 (F)	1.00	#1278
US 29/Camelot Drive	PM Peak		Camelot Drive (WB)	452.7 (F)	0.80	91
US 29/Lewis & Clark U-Turn N	PM Peak	4.8 (A)	Lewis & Clark U-Turn N (WB)	168.7 (F)	0.50	115
US 29/Lewis & Clark Drive	PM Peak	10.7 (B)	Lewis & Clark Drive (EB)	55.0 (D)	0.53	m225
US 29/Lewis & Clark U-Turn S	PM Peak	53.0 (D)	Lewis & Clark U-Turn S (EB)	79.8 (E)	1.05	#1418
US 29/U-Turn Access	PM Peak	7.2 (A)	U-Turn Access (WB)	424.4 (F)	0.53	104
US 29/Northside Drive	PM Peak	10.0 (B)	Northside Drive (EB)	57.3 (E)	0.78	571
US 29/Airport Acres Road N	PM Peak		Airport Acres Road North (WB)	43.5 (E)	0.64	7
US 29/Airport Acres Road S	PM Peak		Airport Acres Road South (EB)	18.9 (C)	0.78	5
US 29/Airport Road	PM Peak	126.9 (F)	US 29 (WB)	286.8 (F)	1.37	#1586

¹ Average intersection delay, LOS reported only for signalized intersections

² Reported delay, LOS, v/c, and 95th percentile queues represent the worst-performing metric at each intersection

³ 95th percentile queues rounded up to the nearest whole number

Figure 9 Future No-Build AM Conditions Operational Analysis

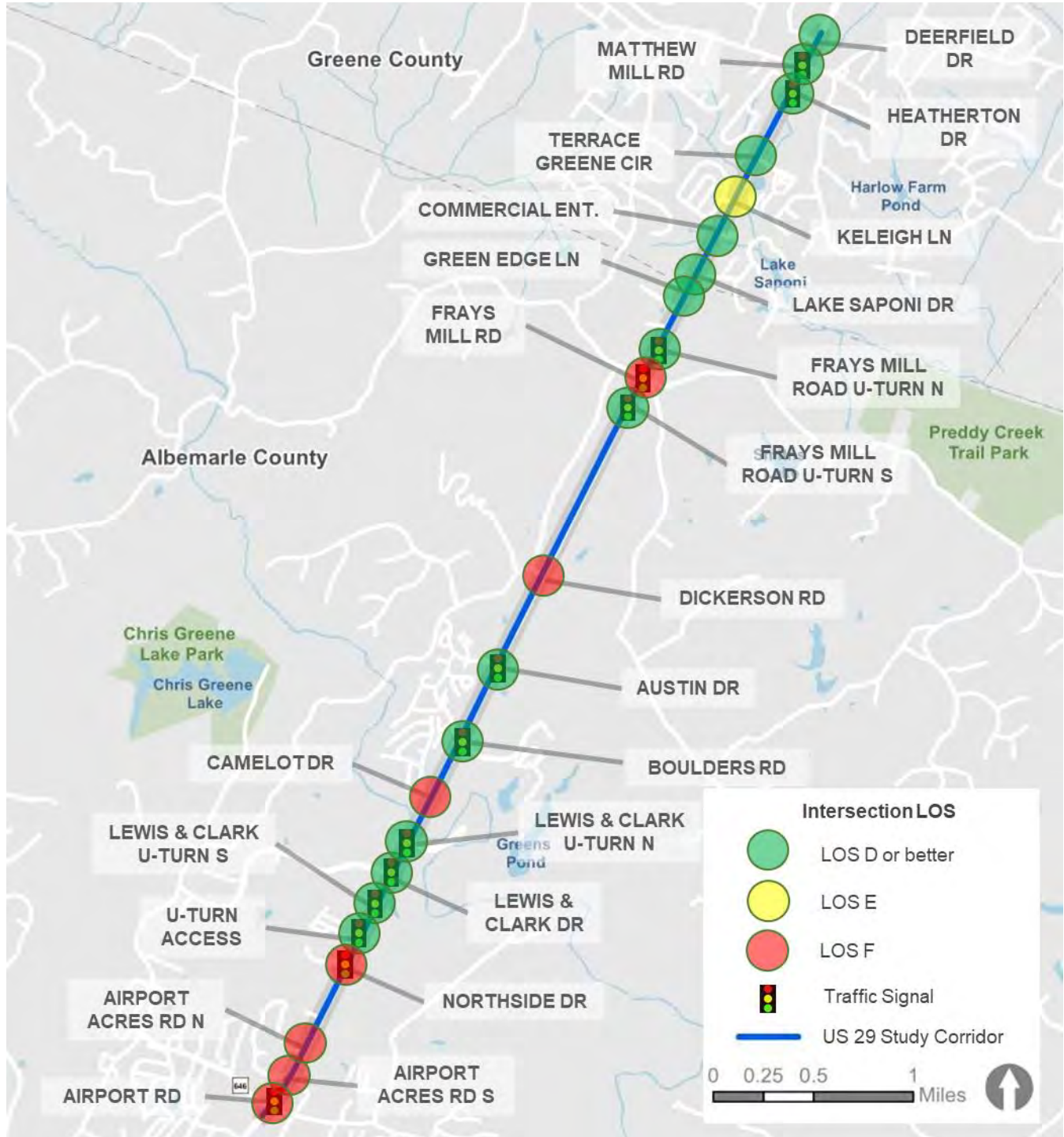

Note: All unsignalized intersections are displaying the worst, critical movement.
 Source: Kittelson 2021.

Figure 10 Future No-Build PM Conditions Operational Analysis

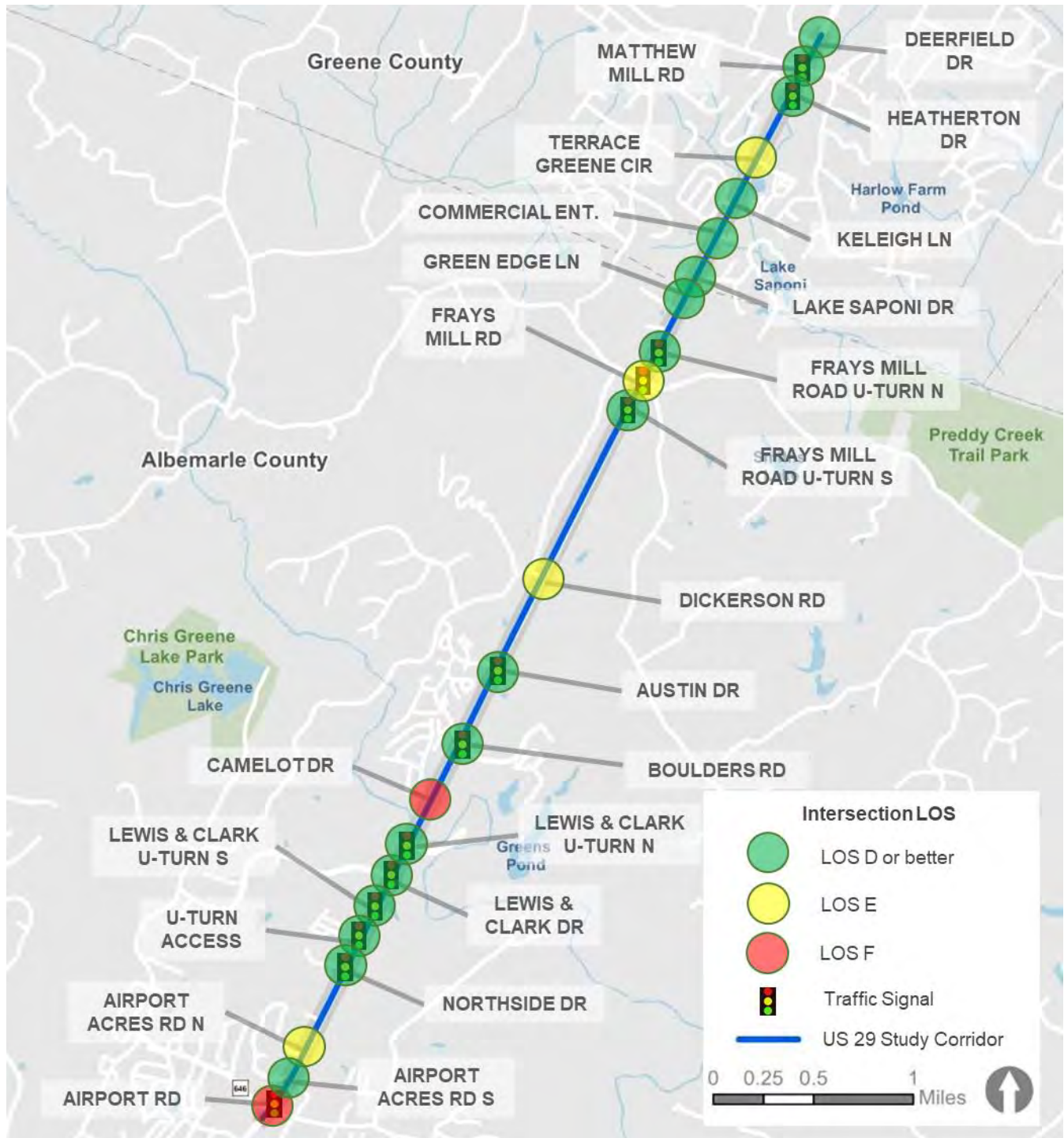

Note: All unsignalized intersections are displaying the worst, critical movement.
 Source: Kittelson 2021.

4.0 BICYCLE AND PEDESTRIAN FACILITIES

This section summarizes the approach and findings of the bicycle and pedestrian facilities analysis. It outlines existing and planned facilities along the study corridor.

4.1 Existing Bicycle and Pedestrian Facilities

It is important for decision-makers to consider accessibility for non-motorized modes when planning. If walking and biking routes are uncomfortable and inconvenient, people are more likely to opt to drive over other modes of travel.

Industry research has shown that an average pedestrian is willing to walk five minutes, or a quarter-mile, to reach a destination. Improvements in the quality of the trip will increase the average walk distance. Convenient, comfortable walking and biking environments tend to have short blocks and a street grid, so non-motorized travelers can efficiently reach their destinations via multiple routes. Wide sidewalks, street trees, frequent crossing locations, and diverse land uses built to front the street all contribute to a safe and attractive environment where travelers will choose to walk, bike, or take transit.

Given this information, US 29 within the study limits is not a conducive environment for pedestrians and bicyclists. Existing bicycle and pedestrian facilities along the corridor are provided in the following paragraphs.

Existing Bicycle and Pedestrian Facilities Data

Street-level bicycle and pedestrian facility data were obtained from Albemarle and Greene Counties.

Existing Bicycle Facilities

Bicycle facilities are not present along US 29 within the study limits on either the west or east sides of the corridor. Additionally, no bicycle crossings exist. The closest facilities outside of the study area are trails within Preddy Creek Trail Park and Chris Greene Lake Park.

Existing Pedestrian Facilities

Pedestrian facilities are not present along US 29 within the study limits on either the west or east sides of the corridor. However, at the study intersection of US 29/Airport Road, there is a sidewalk along the east side of US 29 south of Airport Road – technically outside of the study limits. Additionally, a sidewalk exists on the north side of Airport Road at the intersection. For both facilities at the southernmost study intersection though, no crossings exist here or anywhere else on the corridor within study limits.

4.2 Planned Bicycle and Pedestrian Facilities

Wide, connected sidewalks and comfortable bicycle facilities both contribute to an appealing bicycle and pedestrian network. **Figure 11** provides guidance on the types of facilities that are appropriate based on roadway speed and volume. Research shows that trip purpose and bicycling experience level may inform bicyclist preferences. Casual and less experienced cyclists will feel safe traveling in mixed traffic along low-speed, low-volume roadways while roadways with higher speeds and volumes may warrant a separated bicycle facility¹.

The minimum speed limit along the US 29 corridor is 45 mph, with most of the study area being 55 mph. Average daily traffic volumes range between 25,000 and 32,000 (**Table 1**). Given these speeds and volumes, the most appropriate bicycle facility along US 29 would be a physically separated facility.

Planned Bicycle and Pedestrian Facilities Data

Planned bicycle and pedestrian facility data were obtained from Albemarle and Greene Counties.

Figure 11 Designing for Comfortable Bicycle Facilities

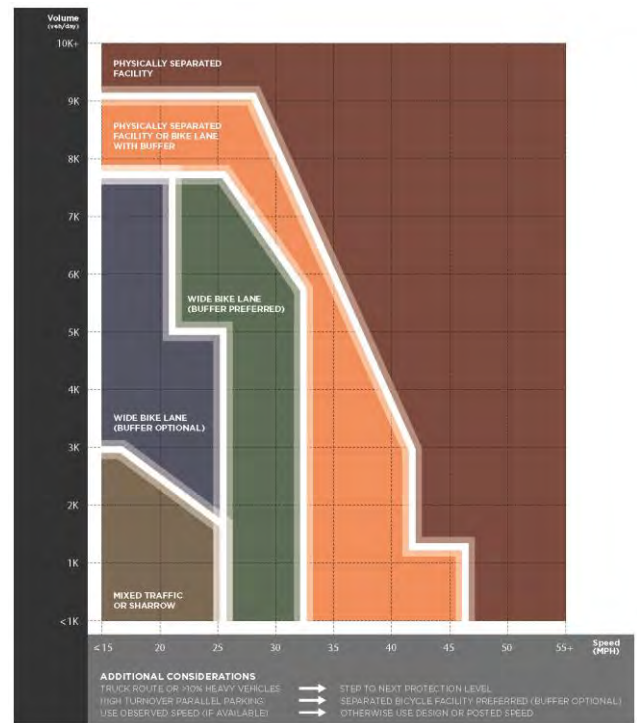

Source: Montgomery County Bicycle Planning Guidance 2014.

Planned Bicycle and Pedestrian Facilities

Albemarle County and Greene County share a long-term vision to provide increased connections and a comfortable non-motorized network throughout the region. A shared-use path is recommended along the west side of US 29 in the study area as specified in the Jefferson Area Bicycle and Pedestrian Plan and Albemarle County Comprehensive Plan.

¹ American Association of State Highways and Transportation Officials, *Guide for the Development of Bicycle Facilities*, Fourth Edition, 2012, p. 15.

5.0 TRANSIT FACILITIES

Two transit services run in the vicinity of the US 29 study area in Albemarle and Greene Counties – Charlottesville Area Transit (CAT) and JAUNT.

The sections that follow provide a brief description of the transit alignment, frequency, and span for each service nearest to the study area.

Charlottesville Area Transit

CAT is the City of Charlottesville’s transit system, providing fixed-route services into Albemarle County. CAT services eleven (11) routes plus a free trolley service between Downtown and UVA.

No route currently runs along US 29 within the study corridor. Bus Routes 5 and 7 provide the northernmost access of the transit system to the Walmart located 2.5 miles south of Hollymead Town Center and 3 miles south of Airport Road. Route 5 services this bus stop Monday through Saturday. Route 7 currently services this stop on Sundays but is proposed to be added to Route 7 for all days of the week. The existing CAT network is provided in **Figure 12**, while the proposed CAT network (including full Route 7 service to the Walmart) is provided in **Figure 13**.

Figure 12 Existing CAT Network

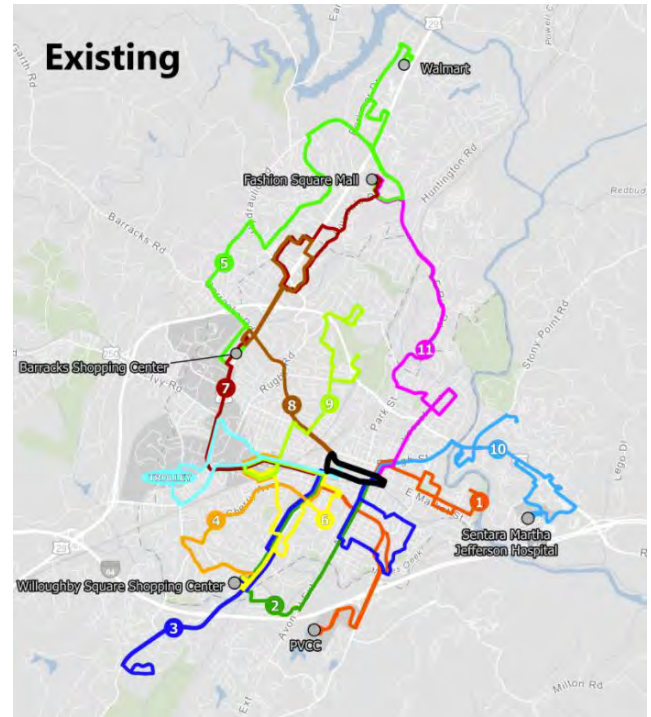

Source: CAT System Optimization Plan, 2021.

Figure 13 Proposed CAT Network

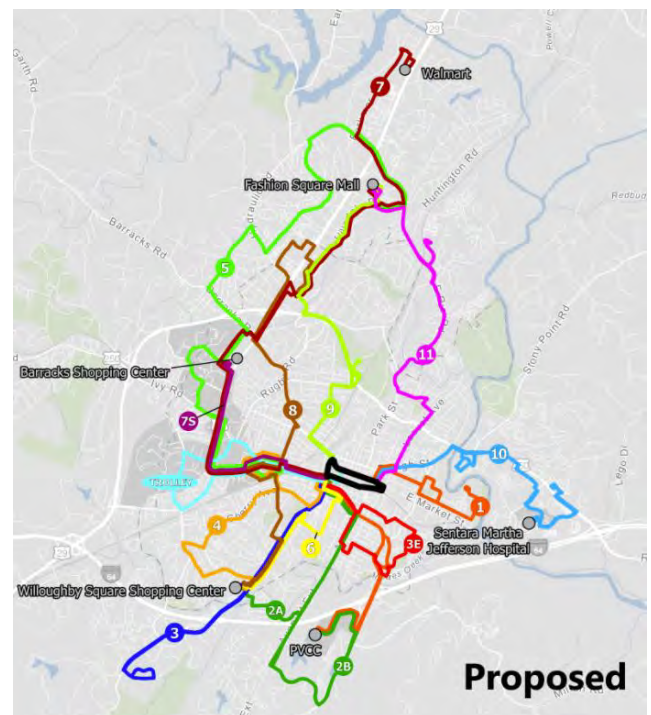

Source: CAT System Optimization Plan, 2021.

JAUNT

JAUNT provides on-call transit, regional commuter, and paratransit service in Greene and Albemarle Counties. Its services in relation to the study area include:

- 29 North CONNECT
- Charlottesville Link Service

JAUNT's CONNECT routes are primarily for commuters into the City of Charlottesville. The 29 North CONNECT route spans from Hollymead Town Center in Albemarle County to UVA's Health System and Downtown. The northernmost bus stop on this route is the Hollymead Food Lion, on the east side of US 29 approximately 900 feet south of Airport Road. The 29 North route operates Monday through Friday.

Charlottesville Link Service is an alternate way to transit to the City of Charlottesville. This is an on-demand service with pick-up and drop-off locations anywhere in Greene County operating Monday through Friday. Reservations are required one day in advance.

6.0 SAFETY

This section summarizes the approach and findings of the crash analysis. The material below discusses study corridor crash patterns and trends; network screening; and the systemic safety evaluation. The analysis focuses on the study corridor only (US 29 between Deerfield Drive and Airport Road).

6.1 Key Findings

Crash Patterns and Trends

- Over half of reported crashes were rear-end crashes (61%).
- Injuries and fatalities accounted for 33% of reported crashes.
- From 2015 to 2020, the top three crash types were rear end (61%), angle (11%), and fixed object – off road (9%).
- Intersection crashes (61%) outnumber segment crashes (39%).

Network Screening and Systemic Findings

- VDOT screened the roadway network using: (1) the Equivalent Property Damage Only (EPDO) safety performance measure; and (2) a risk-based analysis to determine roadway characteristics potentially associated with high crash locations.
- The EPDO performance measure identifies locations that have exhibited a combined greater severity and frequency of crashes than other locations. It gives more weight to locations at which more severe crashes have occurred.

KEY TERMS>>

- **Network Screening** –Evaluating the entire street network to identify high-crash locations based on number of crashes, severity of crashes, and traffic volume.
- **Systemic Analysis** – Identifying common characteristics associated with high-crash locations and prioritizing locations based on common characteristics and crash history.

Common characteristics of high-crash intersections identified through the systemic analysis included:

- Mostly signalized intersections
- High-speed (45 mph) approaches to the intersection
- No marked pedestrian crossings

VDOT identified the following priority locations:

- US 29 and Deerfield Drive
- US 29 and Heatherton Drive
- US 29 and Boulders Road
- US 29 and Lewis & Clark Drive
- US 29 and Matthews Mill Road
- US 29 and Austin Drive

6.2 Study Corridor Crash Patterns and Trends

The following presents study corridor crash trends and patterns. Findings from this section will be used to inform consideration for countermeasures and multimodal transportation solutions that could be effective along the study corridor.

Data and Approach

The most recent six years of complete crash data available for the US 29 study corridor and surrounding area were obtained and analyzed from VDOT's database. The crash data used were from January 1, 2015 to December 31, 2020; there were 798 reported crashes in this period. The location data were used to geocode the crashes and map them in GIS software.

Findings

Crash patterns and trends in the corridor data were identified by evaluating the following:

1. **Crash severity**
2. **Crash type**
3. **Lighting**
4. **Weather condition**
5. **Year**

In the six years of data analyzed, less than 1 percent of reported crashes involved pedestrians and bicyclists (three crashes). The rest of the reported crashes involved motor vehicles or motor vehicles and other objects (see **Figure 14**). Rear-end and angle were the top two crash types. VDOT will use these findings to help identify and prioritize safety treatments.

Severity

Table 5 summarizes the reported crashes by severity. Injury crashes are organized by severe injuries, other visible injuries, and injuries involving a complaint of pain but no visible injury.

More than half (67%) of crashes recorded resulted in property damage only.

Three (<1%) crashes resulted in fatalities, and 35 crashes (4%) resulted in severe injury.

Table 5 Crash Severity, January 2014 – December 2018

Crash Severity	Crash Count
Fatal	3 (<1%)
Injury (severe)	35 (4%)
Injury (other visible)	121 (15%)
Injury (complaint of pain)	108 (14%)
Property damage only (PDO)	531 (67%)

Source: VDOT, Kittelson 2021.

Crash Type

Figure 14 identifies the crash types of the reported crashes.

Figure 14 Vehicle Crash Types, January 2015 – December 2020

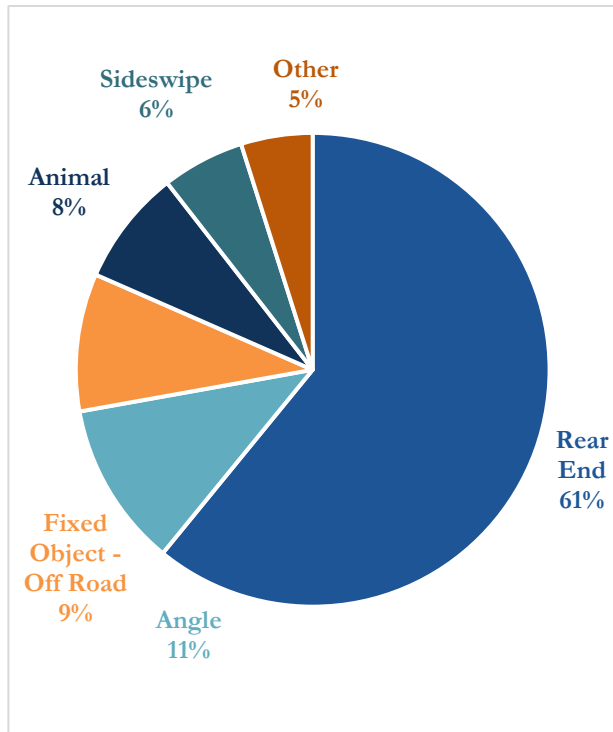

Other includes non-collision (12), fixed object – in road (4), head on (2), pedestrian (2), backed into (2), and crash types that were categorized as “Other” (17) in the data. Source: VDOT, Kittelson 2021.

Rear end (61%) and angle (11%) crashes represent the largest proportions of crash types.

Rear end (486 total crashes) and angle (90 total crashes) make up more than half of all crash types.

Figure 15 summarizes reported crashes by crash type and severity.

Figure 15 Reported Crashes by Crash Type and Severity, January 2015-December 2020

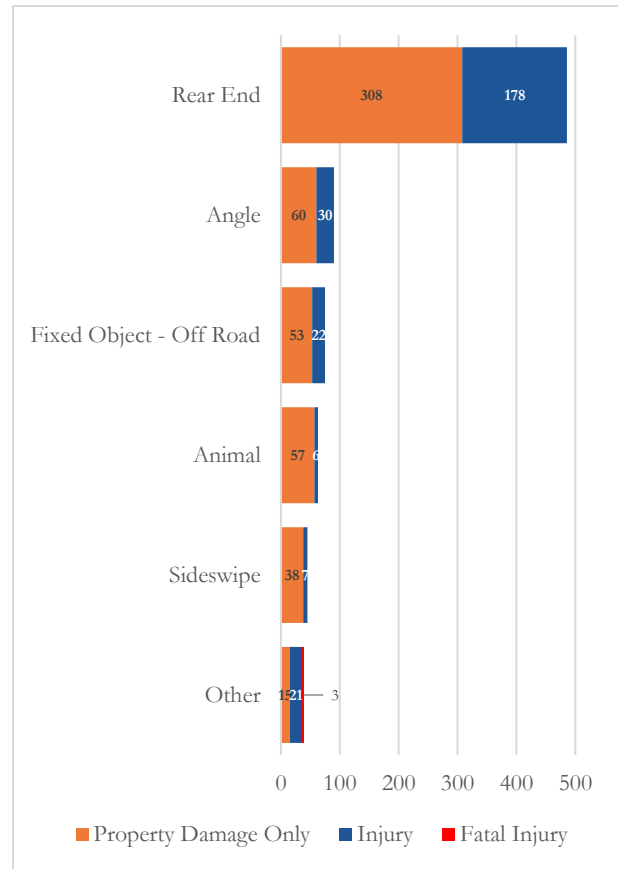

Other includes non-collision (12), fixed object – in road (4), head on (2), pedestrian (2), backed into (2), and crash types that were categorized as “Other” (17) in the data. Source: VDOT, Kittelson 2021.

There were three fatal injuries along the study corridor. All three fatal injuries involved pedestrians.

Lighting

Figure 16 displays the study corridor crash count by reported lighting condition.

Figure 16 Percent of Reported Crashes by Lighting, January 2015 – December 2020

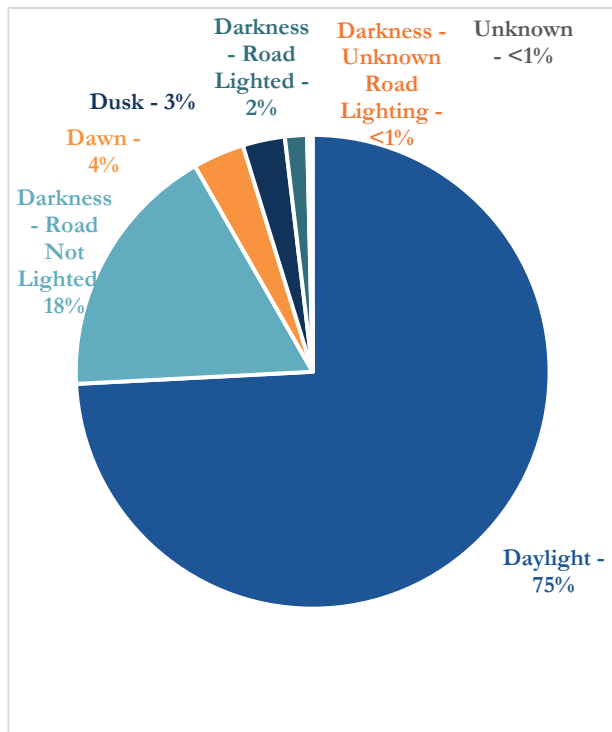

Source: VDOT, Kittelson 2021.

The majority of crashes (75%) occurred under daylight conditions.

Of the crashes that occurred in dark conditions, more crashes occurred in locations without street lights (18%).

Roadway Surface Condition

Figure 17 displays the study corridor crash count by reported roadway surface condition.

Figure 17 Crashes by Roadway Surface Condition, January 2015 – December 2020

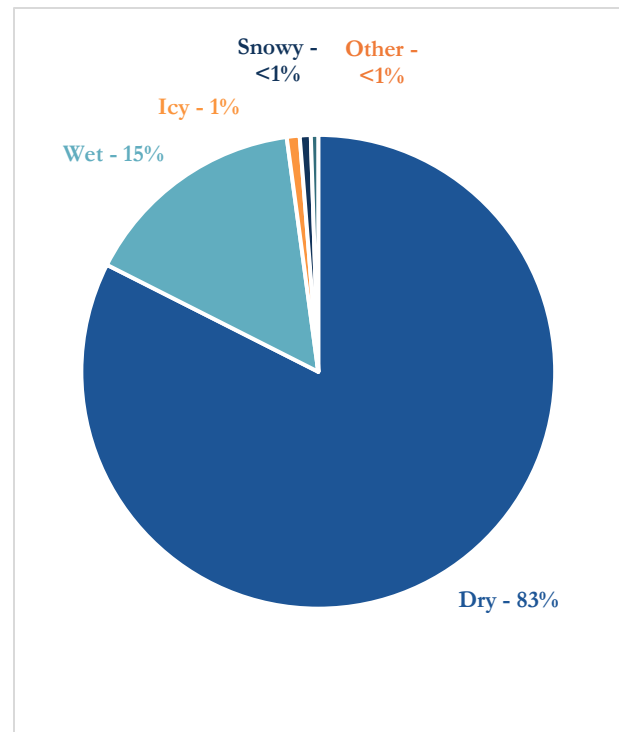

Source: VDOT, Kittelson 2021.

The majority of crashes (83%) occurred under dry conditions.

Crash Year

Figure 18 summarizes the crash count and severity of crashes by year.

2018 had the highest crash count (171).

The number of annual crashes has generally increased since 2015, consistent with observed growth in average annual daily traffic (AADT). However, AADT declined significantly in 2020 due to the COVID-19 pandemic resulting in less crashes in 2020 than in previous years.

Figure 18 Crashes by Year, January 2015 – December 2020

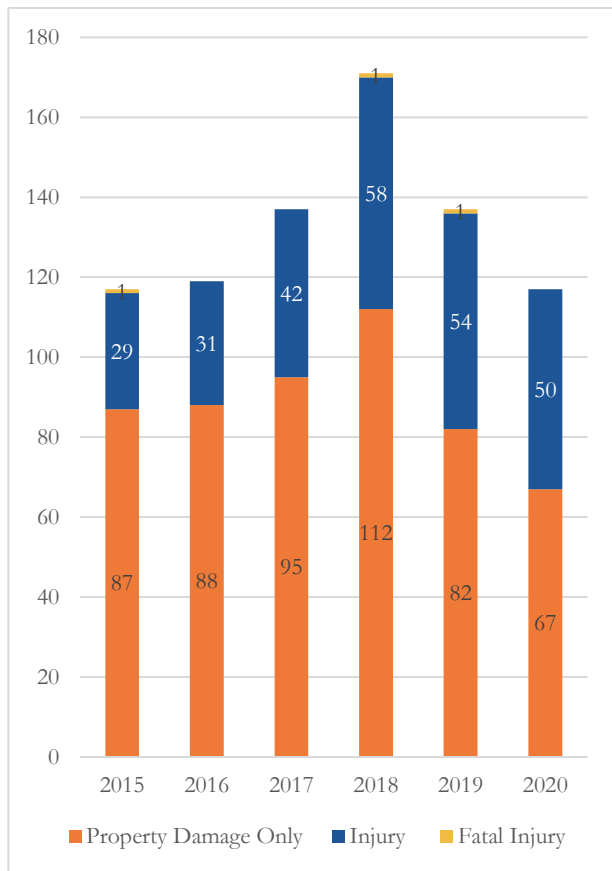

Source: VDOT, Kittelson 2021.

Districtwide Ranking

Using the latest *Highway Safety Manual (HSM)* methods, VDOT conducts a roadway network screening process to identify intersections and segments with Potential for Safety Improvement (PSI). The comparison allows cities and counties to identify local “hot spots” relative to peers. A number 1 ranking indicates the worst performer relative to other peers in the group. Intersections or segments that have a positive PSI value in three or more years are further highlighted as Target Safety Need (TSN) locations. This section presents relevant PSI and TSN rankings for VDOT’s Culpeper District between 2015 and 2020.

Two intersections and three segments along the study corridor were highlighted in the Culpeper District list of PSI locations (**Figure 19**):

US 29 and Frays Mill Road (PSI District Rank: 12)

US 29 and Lewis & Clark Drive (PSI District Rank: 20)

US 29 from Heatherton Drive to Matthews Mill Road (PSI Rank: 90)

US 29 from Matthews Mill Road to Deerfield Drive (PSI Rank: 93)

US 29 from Camelot Drive to Austin Drive (PSI Rank: 127)

Figure 19 Potential for Safety Improvement (PSI) Locations

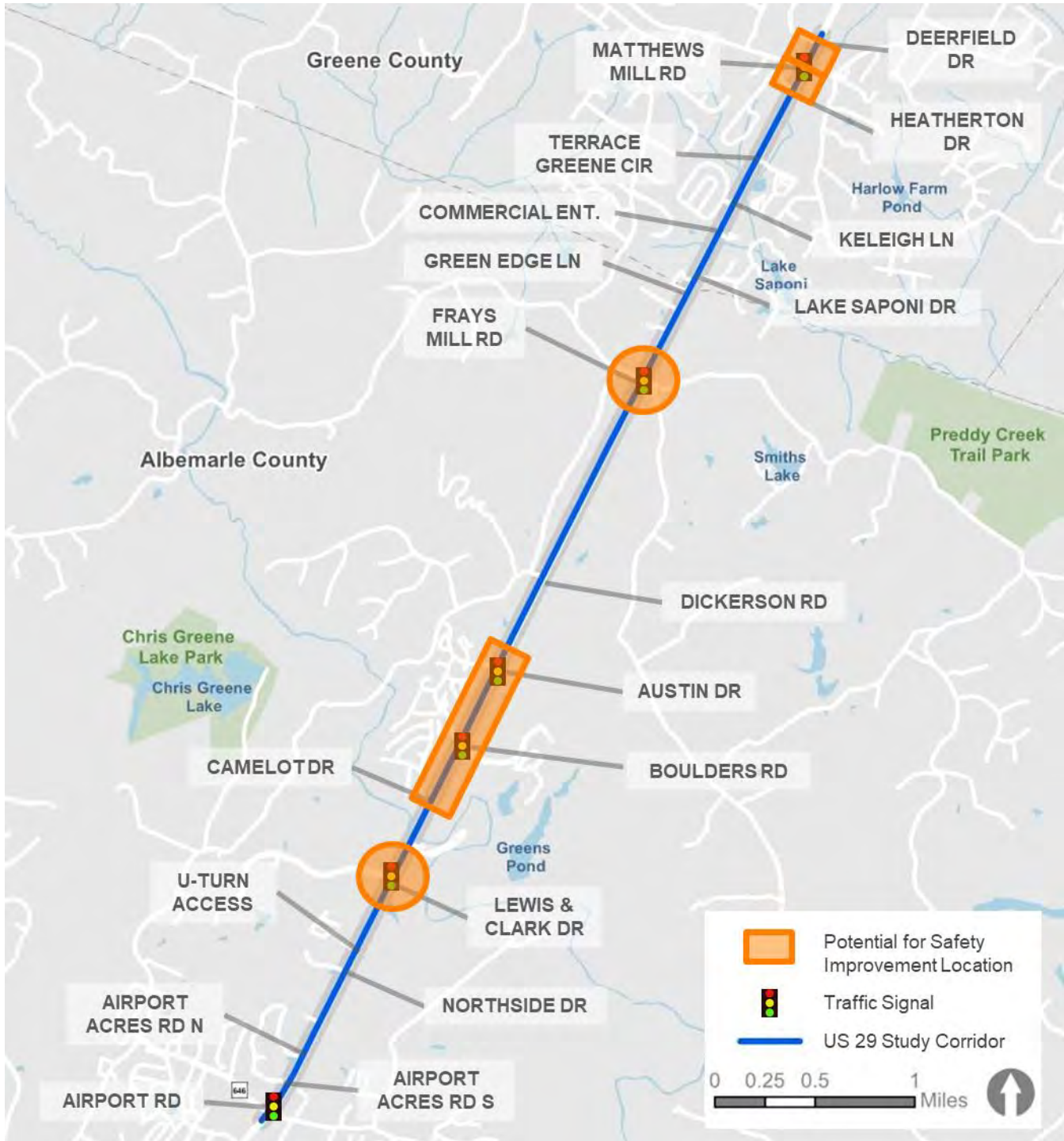

6.3 Network Screening and Systemic Findings

This section describes the network screening and systemic evaluation of the study corridor roadway network. First, the data and approach used to screen the study corridor roadway network and identify potential systemic crash characteristics are described.

Data and Approach

VDOT identified the high-priority safety intersections using the EPDO network screening performance measure from the *HSM*. The EPDO screening calculation was performed for all intersections along the study corridor. The EPDO performance measure is described below.

Equivalent Property Damage Only

The EPDO performance measure assigns weighting factors to crashes by severity relative to PDO crashes. The weighting factors used for the network screening are based on the crash costs by severity used for Caltrans’ Highway Safety Improvement Program Benefit Calculator Tool. Crash costs vary based on location type: signalized intersection, unsignalized intersection, or roadway. The weights for each crash severity by location type are shown in **Table 6**.

Table 6 Crash Weights by Severity and Location Type

Crash Weights by	Location Type	Signalized Intersection	Unsignalized Intersection
	Fatal	126	200
Injury (Severe)	126	200	

Injury (Other Visible)	10.86	10.86
Injury (Complaint of Pain)	6.13	6.13
Property Damage Only (PDO)	1	1

Source: Caltrans, Highway Safety Improvement Program Benefit Calculator Tool, 2016.

The weights generally reflect an order of magnitude difference between the societal costs of fatal and severe injury collisions and non-severe injury collisions. The weighting factors intentionally weigh fatal and severe injuries equally to recognize that the difference between a severe injury crash and a fatal crash is often more of a function of the individuals involved – therefore, both represent locations where VDOT may want to prioritize improvements. The crash weights vary by location type due to the relative costs associated with the crash severity at those location types. Hence, fatal or severe crashes at an unsignalized intersection result in more persons injured or more severely injured in a fatal or severe injury crash and as a result have a higher average cost than at a signalized intersection.

Reported crashes were first coded by severity. Crashes within 250 feet of an intersection were then spatially joined and summarized in ArcGIS to develop the total number of crashes by severity at each intersection. Where intersections were less than 500 feet from each other, crashes were assigned to the nearest intersection. Crashes occurring more than 250 feet from an intersection were excluded from the intersection analysis.

The EPDO score for intersections was calculated by multiplying each crash severity total by its associated weight (by intersection type) and summing the results, using the following formula:

*EPDO Score = Fatal weight * # of fatal crashes + severe injury weight * # of severe injury crashes + other visible injury weight * # of other visible injury crashes + complaint of pain injury weight * # of complaint of pain injury weight crashes + PDO crashes*

The EPDO score was then annualized by dividing the score by the number of years (six) of crash data used in the analysis.

Identifying Common Characteristics of High-Crash Intersections

VDOT applied a risk-based analysis of the priority locations identified through the intersection network screening. Risk is defined in this instance as common traffic or physical characteristics shared by the priority intersections.

To determine common crash characteristics, VDOT reviewed the following roadway characteristics for priority sites to help determine common crash characteristics for intersections:

- ▶ Number of vehicle lanes
- ▶ Posted speed
- ▶ Median presence
- ▶ Driveway and curb cut presence
- ▶ Intersection control type
- ▶ Dedicated left- or right-turn lane presence
- ▶ Intersection geometry (i.e., presence of offset approaches or intersection skew, number of approaches)
- ▶ Presence of marked crosswalks

For the highest-scoring intersections, roadway characteristic data was collected through a review of aerial imagery and a field visit. This included assessing the number of approaches, shoulder widths, and turn lane configurations, among other items.

VDOT identified consistent trends across the priority locations that could be tied to a roadway characteristic. These were documented as common crash characteristics. Common characteristics of high-crash intersections are discussed in the Findings section below.

Findings

After calculating the network screening performance measures, VDOT identified priority intersections using the annualized EPDO scores. For intersection locations, the EPDO scores ranged from 3.0 (three crashes during the six-year time frame analyzed) to 662.4. **Figure 20** shows the results of the EPDO scoring by quartile for roadway intersection locations.

The results of the network screening analysis show that intersections with a reported crash history are primarily signalized, with the exceptions of the intersections at Deerfield Drive and at Heatherton Drive. One fatal injury occurred at the intersection of US 29 and Deerfield Drive and two fatal injuries occurred at US 29 and Heatherton Drive. VDOT developed its list of priority intersections using the highest-scoring EPDO intersections. The complete list of corridor intersections is given, along with their corresponding EPDO scores, in **Table 7**.

Table 7 Intersection EPDO Scoring results

Intersection	Annualized Equivalent PDO Score	Intersection Control
Priority Intersections²		
US 29 & Deerfield Drive	662.4	Unsignalized
US 29 & Heatherton Drive	640.6	Unsignalized
US 29 & Boulders Road	599.0	Signalized
US 29 & Lewis and Clark Drive	532.7	Signalized
US 29 & Matthew Mills Road	461.6	Signalized
US 29 & Austin Drive	356.4	Signalized
Other Corridor Intersections		
US 29 & Airport Road	339.8	Signalized
US 29 & Frays Mill Road	280.2	Signalized
US 29 & Northside Drive	253.6	Unsignalized
US 29 & U-Turn Access	231.1	Unsignalized
US 29 & Camelot Drive	67.83	Unsignalized
US 29 & Commercial Entrance	65.7	Unsignalized
US 29 & Terrace Greene Circle	37.6	Unsignalized
US 29 & Dickerson Road	35.9	Unsignalized
US 29 & Greene Edge Lane	34.9	Unsignalized
US 29 & Lake Saponi Drive	16.86	Unsignalized
US 29 & Keleigh Lane	15.9	Unsignalized
US 29 & Airport Acres South	7.0	Unsignalized
US 29 & Airport Acres North	3.0	Unsignalized

Source: VDOT, Kittelson 2021.

² A minimum EPDO score of 350 was selected as the criterion for priority corridor intersections.

Common Characteristics of High-Crash Intersections

Based on the review of the identified trends in roadway characteristics that were indicative of more crashes in the priority intersections, VDOT identified the following common characteristics:

- ▶ Mostly signalized intersections
- ▶ High-speed (45 mph) approaches to the intersection
- ▶ No marked pedestrian crossings

Figure 20 Intersection EPDO Scoring results by Quartile

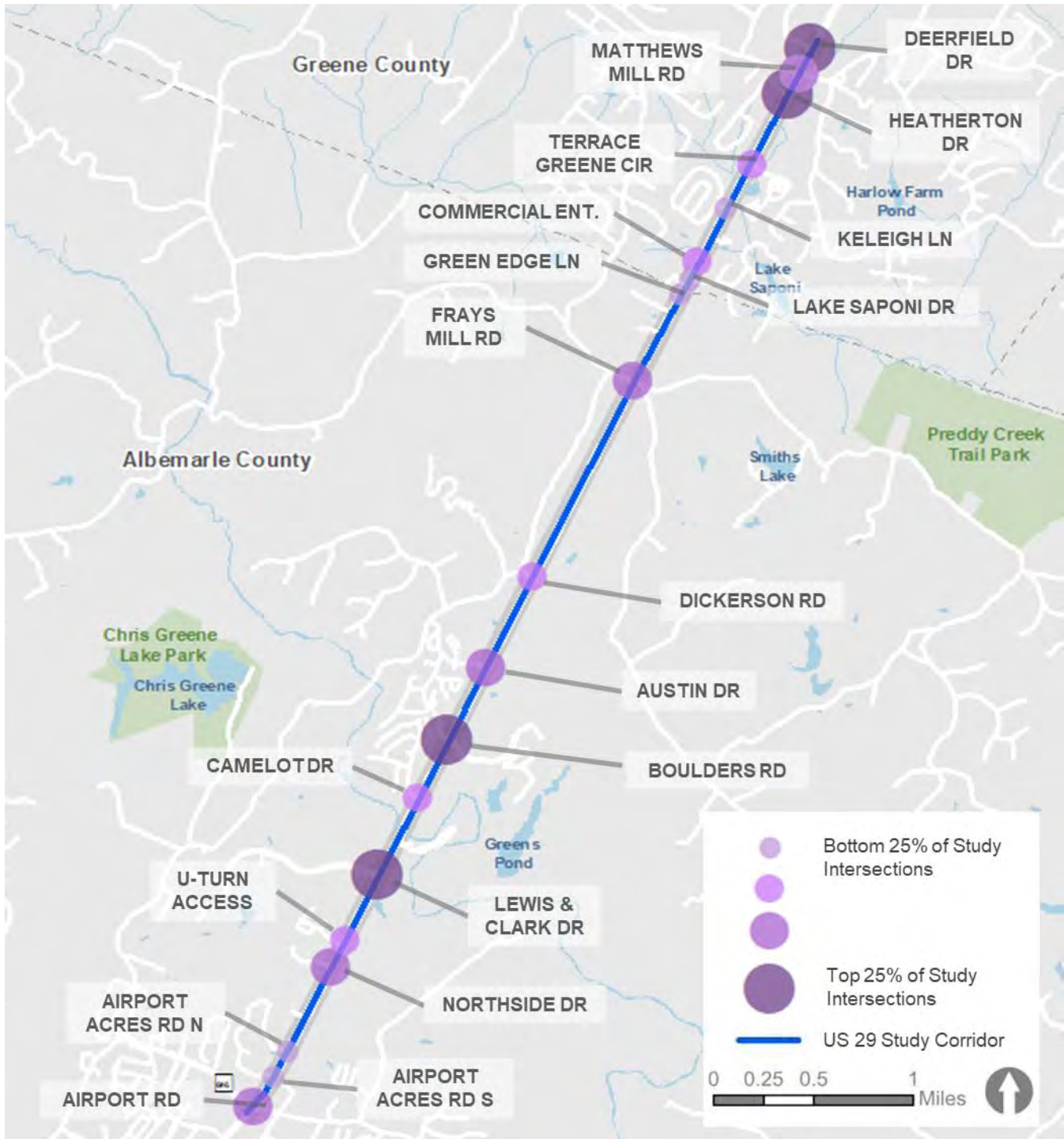

Source: VDOT, Kittelson 2021.

6.4 Priority Locations

Priority Locations

Priority intersections were drawn from the network screening and finalized based on discussions with VDOT and the project Stakeholder Group. The following six intersections were selected as the priority locations because they experienced the most severe crashes along the study corridor:

- ▶ US 29 and Deerfield Drive
- ▶ US 29 and Heatherton Drive
- ▶ US 29 and Boulders Road
- ▶ US 29 and Lewis & Clark Drive
- ▶ US 29 and Matthews Mill Road
- ▶ US 29 and Austin Drive

Location-Specific Analysis Approach

To help inform selection of the focus sites, VDOT refined the corridor-wide crash pattern and trends analysis to focus on the individual priority intersections. This approach allows for a more nuanced understanding of how each priority intersection's safety performance varies across the study corridor. This refined understanding of the individual crash patterns and trends for each location will assist in developing a crash profile for each site that can be used to select appropriate safety treatments to improve safety performance.

This extraction process resulted in a focused crash data set of 251 priority intersection-related crashes. These 251 crashes account for 31% of all reported crashes on the US 29 corridor. Of these 251 crashes, 3 were fatal injury crashes and 29 were

severe injury crashes, accounting for 100% of all reported fatal injury crashes and 83% of severe injury crashes on the US 29 corridor. More detailed summaries of key crash characteristics are discussed below.

Priority Locations Findings

This section discusses crash trends at the priority intersections, highlighting notable differences between patterns in a specific intersection and the corridor-wide patterns previously discussed. The analysis includes the following considerations:

- ▶ Crash severity
- ▶ Crash type
- ▶ Crash lighting conditions
- ▶ Crash weather condition
- ▶ Crash year

Crash Severity

Table 8 summarizes reported crashes by priority intersection and severity.

The three fatal injury crashes occurred at two intersections. Two fatal injury crashes occurred at US 29 and Heatherton Drive and one fatal injury crash occurred at US 29 and Deerfield Drive.

All the priority intersections had at least one fatal or severe injury crash.

US 29 and Boulders Road had the most crashes of the study intersections (69 crashes). 65% of crashes at US 29 and Boulders Road resulted only in property damage. Therefore, the EPDO score was not as high as intersections that had less crashes, but more severe injury crashes.

Crash Type

The most common crash types at the priority locations are the following:

- ▶ Rear-end crashes (71%)
- ▶ Angle crashes (17%)
- ▶ Fixed object – off road (4%)

Figure 21 summarizes crash types at each of the priority intersections.

Table 8 Priority Locations Crashes by Intersection and Severity, January 2015 to December 2020

Intersection	Fatal Crashes	Severe Injury Crashes	Other Visible Injury Crashes	Complaint of Pain Injury Crashes	PDO Crashes	Total Crashes
US 29 and Deerfield Drive	1	0	4	2	19	26
US 29 and Heatherton Drive	2	0	3	1	8	14
US 29 and Boulders Road	0	11	10	3	45	69
US 29 and Lewis & Clark Drive	0	11	5	3	33	52
US 29 and Matthews Mill Road	0	4	14	2	33	53
US 29 and Austin Drive	0	2	6	2	27	37

Source: VDOT, Kittelson, 2021.

Figure 21 Priority Locations Crash Type by Intersection, January 2015 to December 2020

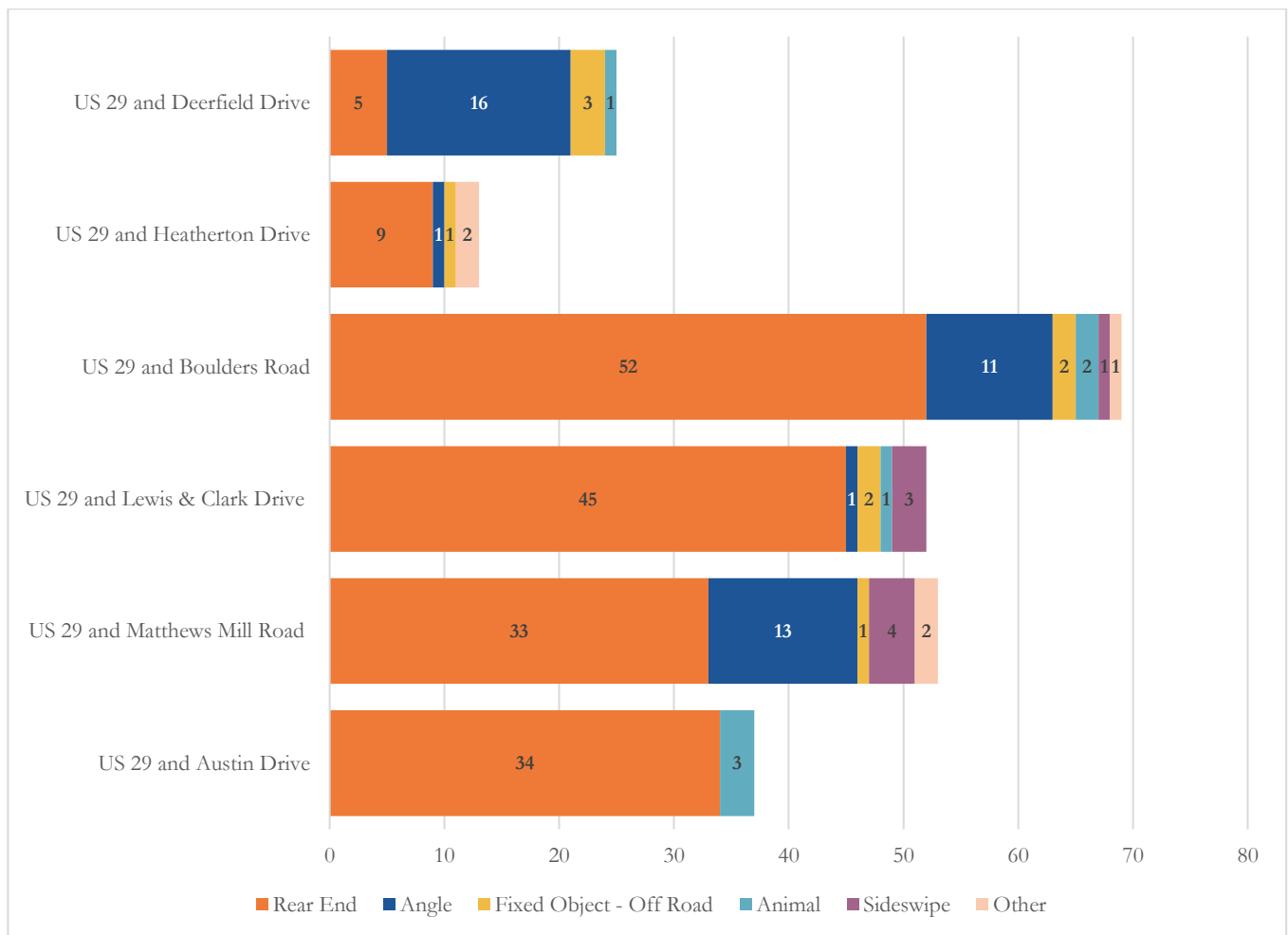

Source: VDOT, Kittelson, 2021.

- ▶ Rear end crashes represent a higher proportion of crashes compared to the corridor-wide average at five of the priority intersections:
 - US 29 and Heatherton Drive
 - US 29 and Boulders Road
 - US 29 and Lewis & Clark Drive
 - US 29 and Matthews Mill Road
 - US 29 and Austin Drive
- ▶ Angle crashes represent a higher proportion of crashes compared to the corridor-wide average at three of the priority intersections:
 - US 29 and Deerfield Drive
 - US 29 and Boulders Road
 - US 29 and Matthews Mill Road
- ▶ A pedestrian-involved crash occurred at two of the priority intersections:
 - US 29 and Deerfield Drive
 - US 29 and Heatherton Drive

Crash Lighting Conditions

As already discussed, most crashes on US 29 occur during daylight conditions. **Figure 22** summarizes crashes by lighting condition at each of the priority intersections.

- ▶ Daylight crashes represented the highest proportion of crashes on the priority intersections.
- ▶ Dark condition crashes (dusk-dawn, dark-streetlights, and dark-no streetlights) represent 20% of crashes at priority intersections.

Figure 22 Reported Crashes by Lighting Condition, January 2015 to December 2020

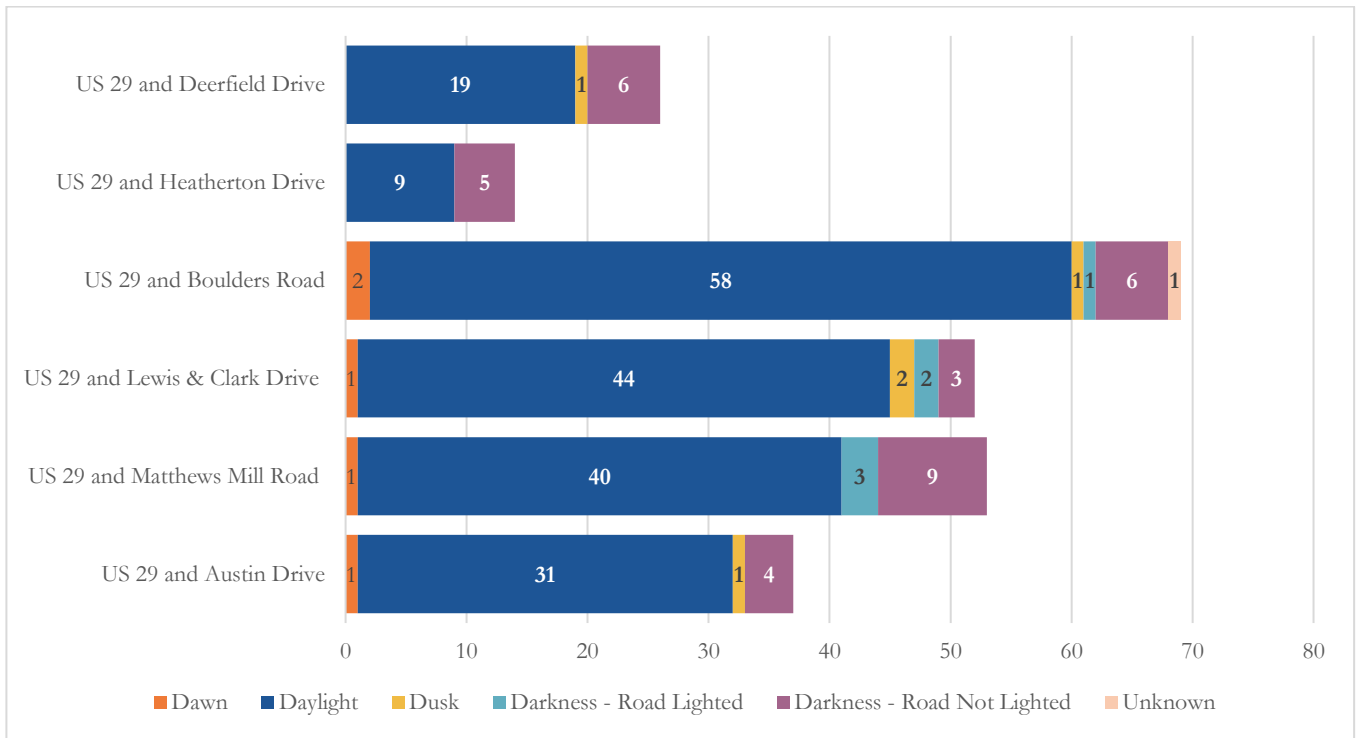

Source: VDOT, Kittelson, 2021.

Crash Roadway Surface Condition

As already reported, most crashes on US 29 involved dry roadway surface conditions. **Figure 23** summarizes crashes by roadway surface condition at each of the priority intersections.

- ▶ Dry roadway surface conditions characterized the highest proportion of crashes on the priority intersections.
- ▶ Wet roadway surface conditions (wet, snowy, icy, slushy) characterized a higher proportion of crashes compared to the corridor-wide average at two of the priority intersections:
 - US 29 and Lewis & Clark Drive
 - US 29 and Austin Drive

Crash Year

As previously discussed, the most crashes occurred in 2018 along the US 29 corridor. Since 2018, crashes have declined slightly along the corridor. A similar pattern is shown at the priority intersections. **Figure 24** summarizes crashes by year at each of the priority intersections.

- ▶ More 2018 crashes occurred at four of the priority intersections compared to the corridor-wide average for 2018 crashes:
 - US 29 and Boulders Road
 - US 29 and Lewis & Clark Drive
 - US 29 and Matthews Mill Road
 - US 29 and Austin Drive

Figure 23 Reported Crashes by Roadway Surface Condition, January 2015 to December 2020

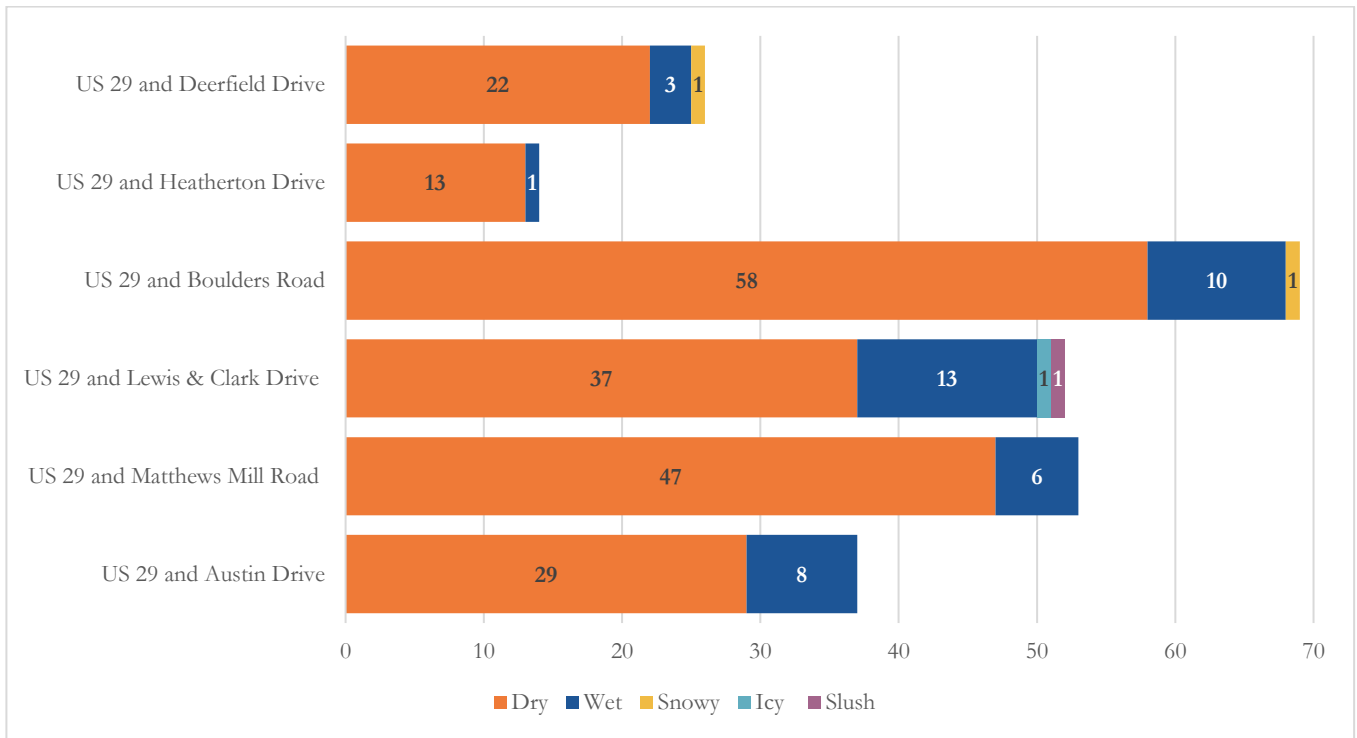

Source: VDOT, Kittelson, 2021.

Figure 24 Reported Crashes by Crash Year, January 2015 to December 2020

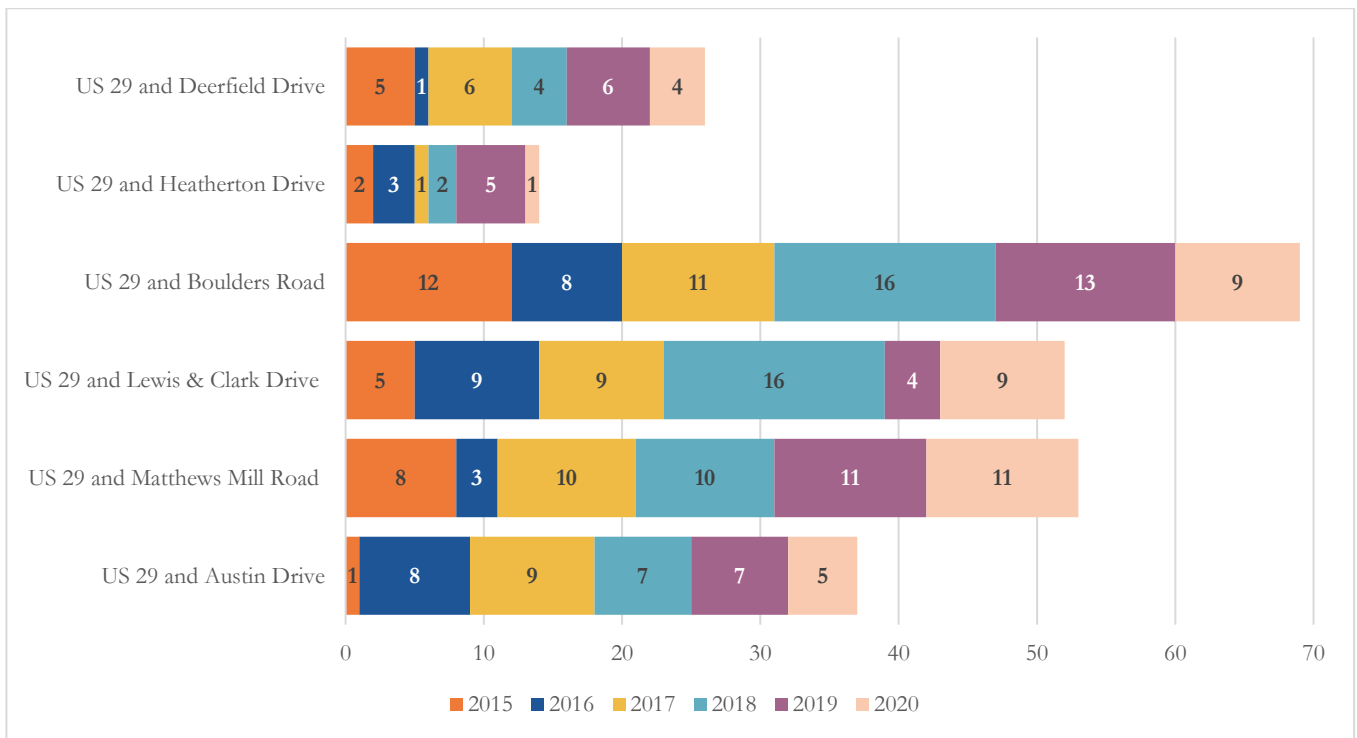

Source: VDOT, Kittelson, 2021.

7.0 CONCLUSION AND NEXT STEPS

The findings in this memorandum will inform the processes for refining the study goals, objectives, and evaluation criteria. VDOT will use insights from the existing conditions analysis to develop potential transportation alternatives that will help meet the vision and goals of the study. These transportation alternatives will be evaluated and revised based on the study evaluation measures and community input.

Attachment A Traffic Counts

Peggy Malone & Associates

(800) 247-8602

File Name : 3-Route 29 and Deerfield Dr AM
 Site Code :
 Start Date : 12/6/2017
 Page No : 1

Groups Printed- Car

Start Time	Route 29 Southbound					Family Dollar Westbound					Route 29 Northbound					Deerfield Dr Eastbound					Int. Total
	Right	Thru	Left	Peds	App. Total	Right	Thru	Left	Peds	App. Total	Right	Thru	Left	Peds	App. Total	Right	Thru	Left	Peds	App. Total	
07:00 AM	7	310	0	0	317	0	0	0	0	0	0	136	2	0	138	4	0	2	0	6	461
07:15 AM	7	350	0	0	357	0	0	0	0	0	0	194	5	0	199	7	0	1	0	8	564
07:30 AM	2	317	0	0	319	0	0	0	0	0	0	180	5	0	185	6	0	1	0	7	511
07:45 AM	3	296	0	0	299	0	0	0	0	0	0	137	1	0	138	5	0	5	0	10	447
Total	19	1273	0	0	1292	0	0	0	0	0	0	647	13	0	660	22	0	9	0	31	1983
08:00 AM	4	292	0	0	296	0	0	1	0	1	0	167	1	0	168	6	1	4	0	11	476
08:15 AM	7	303	0	0	310	0	0	0	0	0	0	137	2	0	139	6	0	3	0	9	458
08:30 AM	8	250	1	0	259	0	0	0	0	0	0	175	6	0	181	1	0	6	0	7	447
08:45 AM	5	242	3	0	250	1	1	0	0	2	2	135	5	0	142	4	0	4	0	8	402
Total	24	1087	4	0	1115	1	1	1	0	3	2	614	14	0	630	17	1	17	0	35	1783
Grand Total	43	2360	4	0	2407	1	1	1	0	3	2	1261	27	0	1290	39	1	26	0	66	3766
Apprch %	1.8	98	0.2	0		33.3	33.3	33.3	0		0.2	97.8	2.1	0		59.1	1.5	39.4	0		
Total %	1.1	62.7	0.1	0	63.9	0	0	0	0	0.1	0.1	33.5	0.7	0	34.3	1	0	0.7	0		1.8

Start Time	Route 29 Southbound				Family Dollar Westbound				Route 29 Northbound				Deerfield Dr Eastbound				Int. Total	
	Right	Thru	Left	App. Total	Right	Thru	Left	App. Total	Right	Thru	Left	App. Total	Right	Thru	Left	App. Total		
Peak Hour Analysis From 07:00 AM to 08:45 AM - Peak 1 of 1																		
Peak Hour for Entire Intersection Begins at 07:15 AM																		
07:15 AM	7	350	0	357	0	0	0	0	0	0	194	5	199	7	0	1	8	564
07:30 AM	2	317	0	319	0	0	0	0	0	0	180	5	185	6	0	1	7	511
07:45 AM	3	296	0	299	0	0	0	0	0	0	137	1	138	5	0	5	10	447
08:00 AM	4	292	0	296	0	0	1	1	0	0	167	1	168	6	1	4	11	476
Total Volume	16	1255	0	1271	0	0	1	1	0	0	678	12	690	24	1	11	36	1998
% App. Total	1.3	98.7	0		0	0	100		0	0	98.3	1.7		66.7	2.8	30.6		
PHF	.571	.896	.000	.890	.000	.000	.250	.250	.000	.874	.600	.867	.857	.250	.550	.818		.886

Peggy Malone & Associates

(800) 247-8602

File Name : 3-Route 29 and Deerfield Dr AM
 Site Code :
 Start Date : 12/6/2017
 Page No : 1

Groups Printed- Truck

Start Time	Route 29 Southbound					Family Dollar Westbound					Route 29 Northbound					Deerfield Dr Eastbound					Int. Total
	Right	Thru	Left	Peds	App. Total	Right	Thru	Left	Peds	App. Total	Right	Thru	Left	Peds	App. Total	Right	Thru	Left	Peds	App. Total	
07:00 AM	0	9	0	0	9	0	0	0	0	0	0	21	0	0	21	0	0	0	0	0	30
07:15 AM	0	10	0	0	10	0	0	0	0	0	0	18	0	0	18	0	0	0	0	0	28
07:30 AM	0	13	0	0	13	0	0	0	0	0	0	21	1	0	22	1	0	0	0	1	36
07:45 AM	2	15	0	0	17	0	0	0	0	0	0	20	0	0	20	1	0	0	0	1	38
Total	2	47	0	0	49	0	0	0	0	0	0	80	1	0	81	2	0	0	0	2	132
08:00 AM	0	13	0	0	13	0	0	0	0	0	0	12	0	0	12	1	0	0	0	1	26
08:15 AM	1	17	0	0	18	0	0	0	0	0	0	12	1	0	13	0	0	0	0	0	31
08:30 AM	0	15	0	0	15	0	0	0	0	0	0	17	0	0	17	0	0	0	0	0	32
08:45 AM	0	11	0	0	11	0	0	0	0	0	0	8	0	0	8	0	0	0	0	0	19
Total	1	56	0	0	57	0	0	0	0	0	0	49	1	0	50	1	0	0	0	1	108
Grand Total	3	103	0	0	106	0	0	0	0	0	0	129	2	0	131	3	0	0	0	3	240
Apprch %	2.8	97.2	0	0		0	0	0	0		0	98.5	1.5	0		100	0	0	0		
Total %	1.2	42.9	0	0	44.2	0	0	0	0	0	0	53.8	0.8	0	54.6	1.2	0	0	0	1.2	

Start Time	Route 29 Southbound				Family Dollar Westbound				Route 29 Northbound				Deerfield Dr Eastbound				Int. Total
	Right	Thru	Left	App. Total	Right	Thru	Left	App. Total	Right	Thru	Left	App. Total	Right	Thru	Left	App. Total	
Peak Hour Analysis From 07:00 AM to 08:45 AM - Peak 1 of 1																	
Peak Hour for Entire Intersection Begins at 07:00 AM																	
07:00 AM	0	9	0	9	0	0	0	0	0	21	0	21	0	0	0	0	30
07:15 AM	0	10	0	10	0	0	0	0	0	18	0	18	0	0	0	28	
07:30 AM	0	13	0	13	0	0	0	0	0	21	1	22	1	0	0	36	
07:45 AM	2	15	0	17	0	0	0	0	0	20	0	20	1	0	0	38	
Total Volume	2	47	0	49	0	0	0	0	0	80	1	81	2	0	0	132	
% App. Total	4.1	95.9	0		0	0	0		0	98.8	1.2		100	0	0		
PHF	.250	.783	.000	.721	.000	.000	.000	.000	.000	.952	.250	.920	.500	.000	.000	.868	

Peggy Malone & Associates

(800) 247-8602

File Name : 3-Route 29 and Deerfield Dr AM
 Site Code :
 Start Date : 12/6/2017
 Page No : 1

Groups Printed- Combined

Start Time	Route 29 Southbound					Family Dollar Westbound					Route 29 Northbound					Deerfield Dr Eastbound					Int. Total
	Right	Thru	Left	Peds	App. Total	Right	Thru	Left	Peds	App. Total	Right	Thru	Left	Peds	App. Total	Right	Thru	Left	Peds	App. Total	
07:00 AM	7	319	0	0	326	0	0	0	0	0	0	157	2	0	159	4	0	2	0	6	491
07:15 AM	7	360	0	0	367	0	0	0	0	0	0	212	5	0	217	7	0	1	0	8	592
07:30 AM	2	330	0	0	332	0	0	0	0	0	0	201	6	0	207	7	0	1	0	8	547
07:45 AM	5	311	0	0	316	0	0	0	0	0	0	157	1	0	158	6	0	5	0	11	485
Total	21	1320	0	0	1341	0	0	0	0	0	0	727	14	0	741	24	0	9	0	33	2115
08:00 AM	4	305	0	0	309	0	0	1	0	1	0	179	1	0	180	7	1	4	0	12	502
08:15 AM	8	320	0	0	328	0	0	0	0	0	0	149	3	0	152	6	0	3	0	9	489
08:30 AM	8	265	1	0	274	0	0	0	0	0	0	192	6	0	198	1	0	6	0	7	479
08:45 AM	5	253	3	0	261	1	1	0	0	2	2	143	5	0	150	4	0	4	0	8	421
Total	25	1143	4	0	1172	1	1	1	0	3	2	663	15	0	680	18	1	17	0	36	1891
Grand Total	46	2463	4	0	2513	1	1	1	0	3	2	1390	29	0	1421	42	1	26	0	69	4006
Apprch %	1.8	98	0.2	0		33.3	33.3	33.3	0		0.1	97.8	2	0		60.9	1.4	37.7	0		
Total %	1.1	61.5	0.1	0	62.7	0	0	0	0	0.1	0	34.7	0.7	0	35.5	1	0	0.6	0	1.7	

Start Time	Route 29 Southbound				Family Dollar Westbound				Route 29 Northbound				Deerfield Dr Eastbound				Int. Total
	Right	Thru	Left	App. Total	Right	Thru	Left	App. Total	Right	Thru	Left	App. Total	Right	Thru	Left	App. Total	
Peak Hour Analysis From 07:00 AM to 08:45 AM - Peak 1 of 1																	
Peak Hour for Entire Intersection Begins at 07:15 AM																	
07:15 AM	7	360	0	367	0	0	0	0	0	212	5	217	7	0	1	8	592
07:30 AM	2	330	0	332	0	0	0	0	0	201	6	207	7	0	1	8	547
07:45 AM	5	311	0	316	0	0	0	0	0	157	1	158	6	0	5	11	485
08:00 AM	4	305	0	309	0	0	1	1	0	179	1	180	7	1	4	12	502
Total Volume	18	1306	0	1324	0	0	1	1	0	749	13	762	27	1	11	39	2126
% App. Total	1.4	98.6	0		0	0	100		0	98.3	1.7		69.2	2.6	28.2		
PHF	.643	.907	.000	.902	.000	.000	.250	.250	.000	.883	.542	.878	.964	.250	.550	.813	.898

Peggy Malone & Associates

(800) 247-8602

File Name : 3-Route 29 and Deerfield Dr PM
 Site Code :
 Start Date : 12/6/2017
 Page No : 1

Groups Printed- Car

Start Time	Route 29 Southbound					Family Dollar Westbound					Route 29 Northbound					Deerfield Dr Eastbound					Int. Total
	Right	Thru	Left	Peds	App. Total	Right	Thru	Left	Peds	App. Total	Right	Thru	Left	Peds	App. Total	Right	Thru	Left	Peds	App. Total	
04:00 PM	17	204	2	0	223	3	1	1	0	5	5	293	11	0	309	6	2	13	0	21	558
04:15 PM	14	209	0	0	223	7	1	2	0	10	6	328	10	0	344	1	0	6	0	7	584
04:30 PM	13	228	0	0	241	4	1	3	0	8	7	324	9	0	340	4	0	9	0	13	602
04:45 PM	14	217	2	0	233	6	0	2	0	8	9	363	7	0	379	3	1	12	0	16	636
Total	58	858	4	0	920	20	3	8	0	31	27	1308	37	0	1372	14	3	40	0	57	2380
05:00 PM	14	203	1	0	218	4	0	4	0	8	4	323	6	0	333	9	0	13	0	22	581
05:15 PM	11	208	3	0	222	6	2	2	0	10	8	329	14	0	351	6	0	8	0	14	597
05:30 PM	7	217	1	0	225	2	1	1	0	4	2	370	6	0	378	4	0	16	0	20	627
05:45 PM	7	200	2	0	209	5	1	3	0	9	4	367	11	0	382	1	0	7	0	8	608
Total	39	828	7	0	874	17	4	10	0	31	18	1389	37	0	1444	20	0	44	0	64	2413
Grand Total	97	1686	11	0	1794	37	7	18	0	62	45	2697	74	0	2816	34	3	84	0	121	4793
Apprch %	5.4	94	0.6	0		59.7	11.3	29	0		1.6	95.8	2.6	0		28.1	2.5	69.4	0		
Total %	2	35.2	0.2	0	37.4	0.8	0.1	0.4	0	1.3	0.9	56.3	1.5	0	58.8	0.7	0.1	1.8	0	2.5	

Start Time	Route 29 Southbound				Family Dollar Westbound				Route 29 Northbound				Deerfield Dr Eastbound				Int. Total
	Right	Thru	Left	App. Total	Right	Thru	Left	App. Total	Right	Thru	Left	App. Total	Right	Thru	Left	App. Total	
Peak Hour Analysis From 04:00 PM to 05:45 PM - Peak 1 of 1																	
Peak Hour for Entire Intersection Begins at 04:45 PM																	
04:45 PM	14	217	2	233	6	0	2	8	9	363	7	379	3	1	12	16	636
05:00 PM	14	203	1	218	4	0	4	8	4	323	6	333	9	0	13	22	581
05:15 PM	11	208	3	222	6	2	2	10	8	329	14	351	6	0	8	14	597
05:30 PM	7	217	1	225	2	1	1	4	2	370	6	378	4	0	16	20	627
Total Volume	46	845	7	898	18	3	9	30	23	1385	33	1441	22	1	49	72	2441
% App. Total	5.1	94.1	0.8		60	10	30		1.6	96.1	2.3		30.6	1.4	68.1		
PHF	.821	.974	.583	.964	.750	.375	.563	.750	.639	.936	.589	.951	.611	.250	.766	.818	.960

Peggy Malone & Associates

(800) 247-8602

File Name : 3-Route 29 and Deerfield Dr PM
 Site Code :
 Start Date : 12/6/2017
 Page No : 1

Groups Printed- Truck

Start Time	Route 29 Southbound					Family Dollar Westbound					Route 29 Northbound					Deerfield Dr Eastbound					Int. Total
	Right	Thru	Left	Peds	App. Total	Right	Thru	Left	Peds	App. Total	Right	Thru	Left	Peds	App. Total	Right	Thru	Left	Peds	App. Total	
04:00 PM	0	16	0	0	16	0	0	0	0	0	0	8	1	0	9	0	0	1	0	1	26
04:15 PM	0	9	0	0	9	0	0	0	0	0	0	11	0	0	11	0	0	1	0	1	21
04:30 PM	0	8	0	0	8	0	0	0	0	0	0	7	0	0	7	0	0	0	0	0	15
04:45 PM	0	6	0	0	6	0	0	0	0	0	1	8	0	0	9	0	0	0	0	0	15
Total	0	39	0	0	39	0	0	0	0	0	1	34	1	0	36	0	0	2	0	2	77
05:00 PM	0	4	0	0	4	0	1	0	0	1	0	13	0	0	13	0	0	1	0	1	19
05:15 PM	0	3	0	0	3	0	0	0	0	0	0	5	0	0	5	0	0	0	0	0	8
05:30 PM	0	7	0	0	7	0	0	0	0	0	0	10	0	0	10	0	0	0	0	0	17
05:45 PM	0	6	0	0	6	0	0	0	0	0	0	4	0	0	4	0	0	0	0	0	10
Total	0	20	0	0	20	0	1	0	0	1	0	32	0	0	32	0	0	1	0	1	54
Grand Total	0	59	0	0	59	0	1	0	0	1	1	66	1	0	68	0	0	3	0	3	131
Apprch %	0	100	0	0		0	100	0	0		1.5	97.1	1.5	0		0	0	100	0		
Total %	0	45	0	0	45	0	0.8	0	0	0.8	0.8	50.4	0.8	0	51.9	0	0	2.3	0	2.3	

Start Time	Route 29 Southbound				Family Dollar Westbound				Route 29 Northbound				Deerfield Dr Eastbound				Int. Total
	Right	Thru	Left	App. Total	Right	Thru	Left	App. Total	Right	Thru	Left	App. Total	Right	Thru	Left	App. Total	
Peak Hour Analysis From 04:00 PM to 05:45 PM - Peak 1 of 1																	
Peak Hour for Entire Intersection Begins at 04:00 PM																	
04:00 PM	0	16	0	16	0	0	0	0	0	8	1	9	0	0	1	1	26
04:15 PM	0	9	0	9	0	0	0	0	0	11	0	11	0	0	1	1	21
04:30 PM	0	8	0	8	0	0	0	0	0	7	0	7	0	0	0	0	15
04:45 PM	0	6	0	6	0	0	0	0	0	1	8	9	0	0	0	0	15
Total Volume	0	39	0	39	0	0	0	0	0	1	34	1	36	0	0	2	77
% App. Total	0	100	0		0	0	0			2.8	94.4	2.8		0	0	100	
PHF	.000	.609	.000	.609	.000	.000	.000	.000	.000	.250	.773	.250	.818	.000	.000	.500	.740

Peggy Malone & Associates

(800) 247-8602

File Name : 3-Route 29 and Deerfield Dr PM
 Site Code :
 Start Date : 12/6/2017
 Page No : 1

Groups Printed- Combined

Start Time	Route 29 Southbound					Family Dollar Westbound					Route 29 Northbound					Deerfield Dr Eastbound					Int. Total
	Right	Thru	Left	Peds	App. Total	Right	Thru	Left	Peds	App. Total	Right	Thru	Left	Peds	App. Total	Right	Thru	Left	Peds	App. Total	
04:00 PM	17	220	2	0	239	3	1	1	0	5	5	301	12	0	318	6	2	14	0	22	584
04:15 PM	14	218	0	0	232	7	1	2	0	10	6	339	10	0	355	1	0	7	0	8	605
04:30 PM	13	236	0	0	249	4	1	3	0	8	7	331	9	0	347	4	0	9	0	13	617
04:45 PM	14	223	2	0	239	6	0	2	0	8	10	371	7	0	388	3	1	12	0	16	651
Total	58	897	4	0	959	20	3	8	0	31	28	1342	38	0	1408	14	3	42	0	59	2457
05:00 PM	14	207	1	0	222	4	1	4	0	9	4	336	6	0	346	9	0	14	0	23	600
05:15 PM	11	211	3	0	225	6	2	2	0	10	8	334	14	0	356	6	0	8	0	14	605
05:30 PM	7	224	1	0	232	2	1	1	0	4	2	380	6	0	388	4	0	16	0	20	644
05:45 PM	7	206	2	0	215	5	1	3	0	9	4	371	11	0	386	1	0	7	0	8	618
Total	39	848	7	0	894	17	5	10	0	32	18	1421	37	0	1476	20	0	45	0	65	2467
Grand Total	97	1745	11	0	1853	37	8	18	0	63	46	2763	75	0	2884	34	3	87	0	124	4924
Apprch %	5.2	94.2	0.6	0		58.7	12.7	28.6	0		1.6	95.8	2.6	0		27.4	2.4	70.2	0		
Total %	2	35.4	0.2	0	37.6	0.8	0.2	0.4	0	1.3	0.9	56.1	1.5	0	58.6	0.7	0.1	1.8	0	2.5	

Start Time	Route 29 Southbound				Family Dollar Westbound				Route 29 Northbound				Deerfield Dr Eastbound				Int. Total
	Right	Thru	Left	App. Total	Right	Thru	Left	App. Total	Right	Thru	Left	App. Total	Right	Thru	Left	App. Total	
Peak Hour Analysis From 04:00 PM to 05:45 PM - Peak 1 of 1																	
Peak Hour for Entire Intersection Begins at 04:45 PM																	
04:45 PM	14	223	2	239	6	0	2	8	10	371	7	388	3	1	12	16	651
05:00 PM	14	207	1	222	4	1	4	9	4	336	6	346	9	0	14	23	600
05:15 PM	11	211	3	225	6	2	2	10	8	334	14	356	6	0	8	14	605
05:30 PM	7	224	1	232	2	1	1	4	2	380	6	388	4	0	16	20	644
Total Volume	46	865	7	918	18	4	9	31	24	1421	33	1478	22	1	50	73	2500
% App. Total	5	94.2	0.8		58.1	12.9	29		1.6	96.1	2.2		30.1	1.4	68.5		
PHF	.821	.965	.583	.960	.750	.500	.563	.775	.600	.935	.589	.952	.611	.250	.781	.793	.960

Peggy Malone & Associates

(800) 247-8602

File Name : 1-Route 29 and Route 607
 Site Code :
 Start Date : 12/6/2017
 Page No : 2

Start Time	Route 29 Southbound				Route 607 Westbound				Route 29 Northbound				Route 607 Eastbound				Int. Total
	Right	Thru	Left	App. Total	Right	Thru	Left	App. Total	Right	Thru	Left	App. Total	Right	Thru	Left	App. Total	
Peak Hour Analysis From 07:00 AM to 11:45 AM - Peak 1 of 1																	
Peak Hour for Entire Intersection Begins at 07:00 AM																	
07:00 AM	1	299	11	311	12	15	94	121	34	114	6	154	38	10	15	63	649
07:15 AM	0	329	18	347	20	7	116	143	22	142	10	174	48	10	19	77	741
07:30 AM	8	289	14	311	24	6	117	147	24	134	9	167	45	10	21	76	701
07:45 AM	6	276	10	292	14	6	80	100	21	96	12	129	34	13	18	65	586
Total Volume	15	1193	53	1261	70	34	407	511	101	486	37	624	165	43	73	281	2677
% App. Total	1.2	94.6	4.2		13.7	6.7	79.6		16.2	77.9	5.9		58.7	15.3	26		
PHF	.469	.907	.736	.909	.729	.567	.870	.869	.743	.856	.771	.897	.859	.827	.869	.912	.903

Peak Hour Analysis From 12:00 PM to 06:45 PM - Peak 1 of 1																	
Peak Hour for Entire Intersection Begins at 04:45 PM																	
04:45 PM	12	181	21	214	18	14	40	72	97	312	34	443	20	12	19	51	780
05:00 PM	18	160	27	205	14	15	48	77	97	318	54	469	25	12	21	58	809
05:15 PM	14	184	25	223	13	21	47	81	73	296	41	410	16	19	14	49	763
05:30 PM	17	193	21	231	21	19	38	78	95	329	35	459	24	14	27	65	833
Total Volume	61	718	94	873	66	69	173	308	362	1255	164	1781	85	57	81	223	3185
% App. Total	7	82.2	10.8		21.4	22.4	56.2		20.3	70.5	9.2		38.1	25.6	36.3		
PHF	.847	.930	.870	.945	.786	.821	.901	.951	.933	.954	.759	.949	.850	.750	.750	.858	.956

Peggy Malone & Associates

(800) 247-8602

File Name : 1-Route 29 and Route 607
 Site Code :
 Start Date : 12/6/2017
 Page No : 2

Start Time	Route 29 Southbound				Route 607 Westbound				Route 29 Northbound				Route 607 Eastbound				Int. Total
	Right	Thru	Left	App. Total	Right	Thru	Left	App. Total	Right	Thru	Left	App. Total	Right	Thru	Left	App. Total	
Peak Hour Analysis From 07:00 AM to 11:45 AM - Peak 1 of 1																	
Peak Hour for Entire Intersection Begins at 10:00 AM																	
10:00 AM	0	21	2	23	0	0	0	0	4	20	0	24	0	0	0	0	47
10:15 AM	0	8	0	8	1	1	3	5	1	19	2	22	2	1	0	3	38
10:30 AM	0	12	0	12	0	0	2	2	2	11	0	13	0	0	2	2	29
10:45 AM	0	19	0	19	2	0	0	2	1	16	1	18	1	0	1	2	41
Total Volume	0	60	2	62	3	1	5	9	8	66	3	77	3	1	3	7	155
% App. Total	0	96.8	3.2		33.3	11.1	55.6		10.4	85.7	3.9		42.9	14.3	42.9		
PHF	.000	.714	.250	.674	.375	.250	.417	.450	.500	.825	.375	.802	.375	.250	.375	.583	.824

Peak Hour Analysis From 12:00 PM to 06:45 PM - Peak 1 of 1																	
Peak Hour for Entire Intersection Begins at 01:00 PM																	
01:00 PM	0	10	0	10	1	0	0	1	1	21	1	23	0	0	0	0	34
01:15 PM	0	16	0	16	0	0	1	1	1	17	0	18	0	1	1	2	37
01:30 PM	1	14	0	15	1	0	1	2	2	17	1	20	0	0	3	3	40
01:45 PM	0	23	0	23	0	0	1	1	1	13	0	14	0	0	1	1	39
Total Volume	1	63	0	64	2	0	3	5	5	68	2	75	0	1	5	6	150
% App. Total	1.6	98.4	0		40	0	60		6.7	90.7	2.7		0	16.7	83.3		
PHF	.250	.685	.000	.696	.500	.000	.750	.625	.625	.810	.500	.815	.000	.250	.417	.500	.938

Peggy Malone & Associates

(800) 247-8602

File Name : 1-Route 29 and Route 607
 Site Code :
 Start Date : 12/6/2017
 Page No : 2

Start Time	Route 29 Southbound				Route 607 Westbound				Route 29 Northbound				Route 607 Eastbound				Int. Total
	Right	Thru	Left	App. Total	Right	Thru	Left	App. Total	Right	Thru	Left	App. Total	Right	Thru	Left	App. Total	
Peak Hour Analysis From 07:00 AM to 11:45 AM - Peak 1 of 1																	
Peak Hour for Entire Intersection Begins at 07:00 AM																	
07:00 AM	1	306	15	322	13	17	94	124	37	130	6	173	38	10	17	65	684
07:15 AM	0	340	18	358	21	7	117	145	25	158	10	193	48	11	20	79	775
07:30 AM	9	300	14	323	25	6	119	150	24	154	9	187	45	11	21	77	737
07:45 AM	6	289	14	309	15	6	82	103	23	113	12	148	35	13	20	68	628
Total Volume	16	1235	61	1312	74	36	412	522	109	555	37	701	166	45	78	289	2824
% App. Total	1.2	94.1	4.6		14.2	6.9	78.9		15.5	79.2	5.3		57.4	15.6	27		
PHF	.444	.908	.847	.916	.740	.529	.866	.870	.736	.878	.771	.908	.865	.865	.929	.915	.911

Peak Hour Analysis From 12:00 PM to 06:45 PM - Peak 1 of 1																	
Peak Hour for Entire Intersection Begins at 04:45 PM																	
04:45 PM	12	187	21	220	19	14	41	74	98	320	34	452	20	12	19	51	797
05:00 PM	18	163	27	208	14	15	48	77	97	332	54	483	25	12	21	58	826
05:15 PM	14	187	25	226	13	21	48	82	74	299	41	414	16	19	14	49	771
05:30 PM	17	200	21	238	21	19	39	79	95	339	35	469	25	14	27	66	852
Total Volume	61	737	94	892	67	69	176	312	364	1290	164	1818	86	57	81	224	3246
% App. Total	6.8	82.6	10.5		21.5	22.1	56.4		20	71	9		38.4	25.4	36.2		
PHF	.847	.921	.870	.937	.798	.821	.917	.951	.929	.951	.759	.941	.860	.750	.750	.848	.952

Route 29 - 607 - 670 Connector Project

2017 Existing Conditions AM Volumes

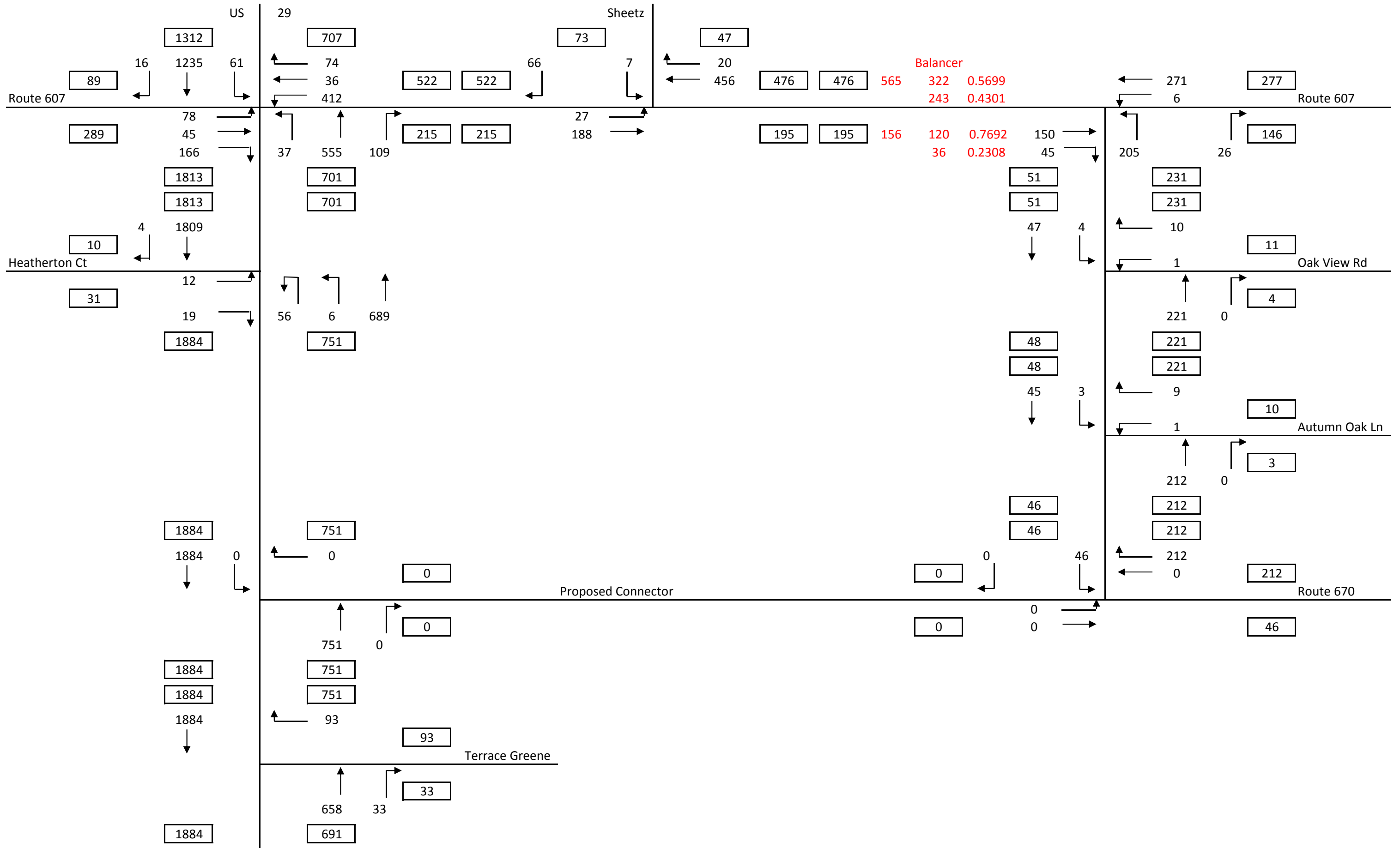

Route 29 - 607 - 670 Connector Project

2017 Existing Conditions PM Volumes

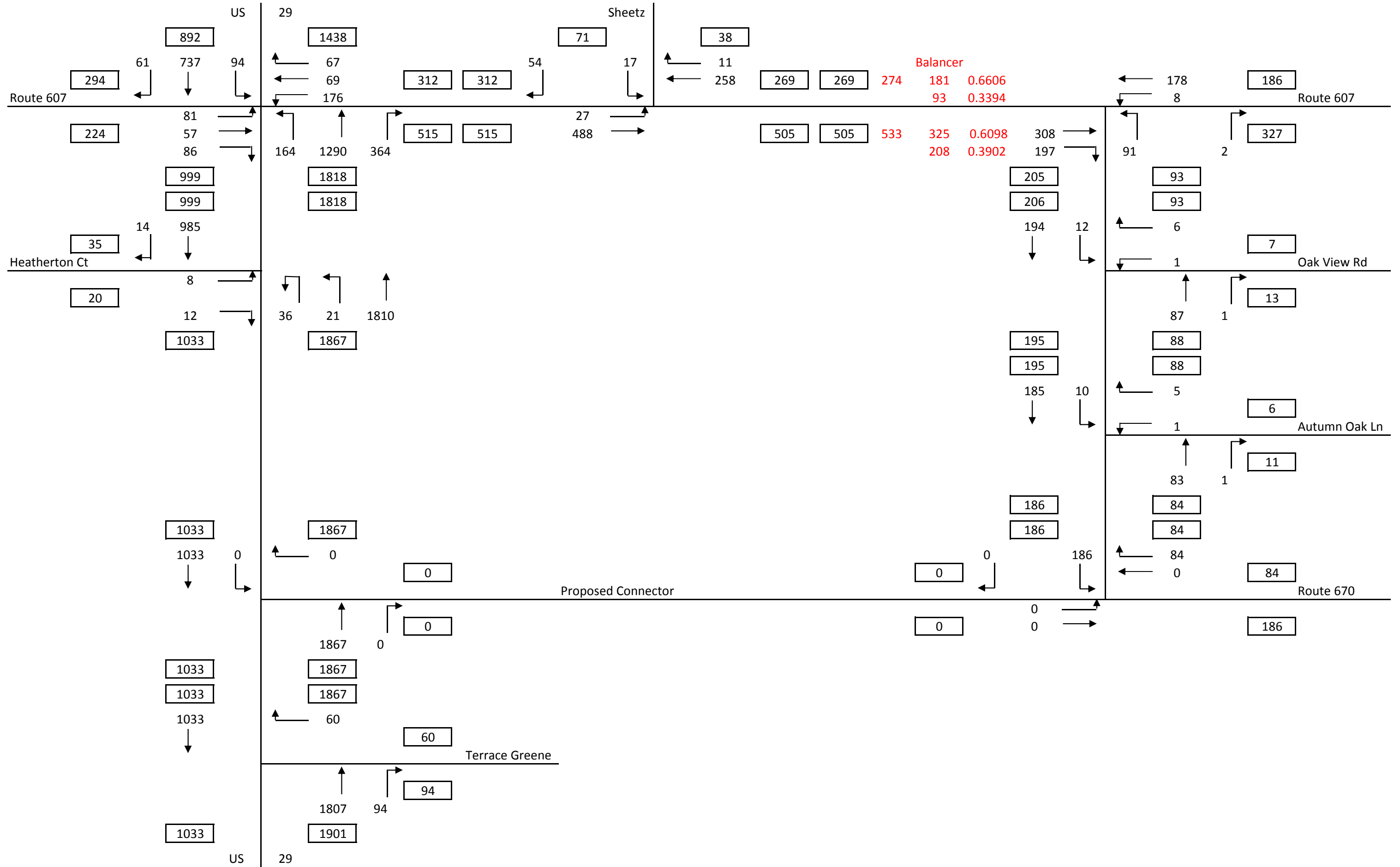

Peggy Malone & Associates, Inc.
(888) 247-8602

File Name : 1-US 29 (Seminole Trail) & Terrace Greene Circle AM
 Site Code :
 Start Date : 10/8/2020
 Page No : 1

Groups Printed- Cars

Start Time	US 29 Southbound					Terrace Greene Circle Westbound					US 29 Northbound					Business Ent/Exit Eastbound					Int. Total
	Right	Thru	Left	Peds	App. Total	Right	Thru	Left	Peds	App. Total	Right	Thru	Left	Peds	App. Total	Right	Thru	Left	Peds	App. Total	
07:00 AM	3	359	0	0	362	24	0	0	0	24	0	114	0	0	114	0	0	0	0	0	500
07:15 AM	0	395	0	0	395	23	0	0	0	23	1	132	0	0	133	0	0	0	0	0	551
07:30 AM	1	405	0	0	406	15	0	0	0	15	1	154	0	0	155	0	0	0	0	0	576
07:45 AM	1	358	0	0	359	18	0	0	0	18	5	164	0	0	169	1	0	0	0	1	547
Total	5	1517	0	0	1522	80	0	0	0	80	7	564	0	0	571	1	0	0	0	1	2174
08:00 AM	1	348	0	0	349	17	0	0	0	17	4	142	0	0	146	1	0	0	0	1	513
08:15 AM	0	315	0	0	315	7	0	0	1	8	1	153	0	0	154	0	0	0	0	0	477
08:30 AM	0	308	0	0	308	13	0	0	0	13	8	137	0	0	145	1	0	0	0	1	467
08:45 AM	1	230	0	0	231	9	0	0	0	9	3	158	0	0	161	1	0	0	0	1	402
Total	2	1201	0	0	1203	46	0	0	1	47	16	590	0	0	606	3	0	0	0	3	1859
Grand Total	7	2718	0	0	2725	126	0	0	1	127	23	1154	0	0	1177	4	0	0	0	4	4033
Apprch %	0.3	99.7	0	0		99.2	0	0	0.8		2	98	0	0		100	0	0	0		
Total %	0.2	67.4	0	0	67.6	3.1	0	0	0	3.1	0.6	28.6	0	0	29.2	0.1	0	0	0	0.1	

Start Time	US 29 Southbound				Terrace Greene Circle Westbound				US 29 Northbound				Business Ent/Exit Eastbound				Int. Total
	Right	Thru	Left	App. Total	Right	Thru	Left	App. Total	Right	Thru	Left	App. Total	Right	Thru	Left	App. Total	
Peak Hour Analysis From 07:00 AM to 08:45 AM - Peak 1 of 1																	
Peak Hour for Entire Intersection Begins at 07:15 AM																	
07:15 AM	0	395	0	395	23	0	0	23	1	132	0	133	0	0	0	0	551
07:30 AM	1	405	0	406	15	0	0	15	1	154	0	155	0	0	0	0	576
07:45 AM	1	358	0	359	18	0	0	18	5	164	0	169	1	0	0	1	547
08:00 AM	1	348	0	349	17	0	0	17	4	142	0	146	1	0	0	1	513
Total Volume	3	1506	0	1509	73	0	0	73	11	592	0	603	2	0	0	2	2187
% App. Total	0.2	99.8	0		100	0	0		1.8	98.2	0		100	0	0		
PHF	.750	.930	.000	.929	.793	.000	.000	.793	.550	.902	.000	.892	.500	.000	.000	.500	.949

Peggy Malone & Associates, Inc.
(888) 247-8602

File Name : 1-US 29 (Seminole Trail) & Terrace Greene Circle AM
 Site Code :
 Start Date : 10/8/2020
 Page No : 1

Groups Printed- Trucks

Start Time	US 29 Southbound					Terrace Greene Circle Westbound					US 29 Northbound					Business Ent/Exit Eastbound					Int. Total	
	Right	Thru	Left	Peds	App. Total	Right	Thru	Left	Peds	App. Total	Right	Thru	Left	Peds	App. Total	Right	Thru	Left	Peds	App. Total		
07:00 AM	0	16	0	0	16	0	0	0	0	0	0	18	0	0	18	0	0	0	0	0	0	34
07:15 AM	0	23	0	0	23	0	0	0	0	0	0	10	0	0	10	0	0	0	0	0	0	33
07:30 AM	0	14	0	0	14	2	0	0	0	2	2	8	0	0	10	0	0	0	0	0	0	26
07:45 AM	1	21	0	0	22	0	0	0	0	0	0	21	0	0	21	0	0	0	0	0	0	43
Total	1	74	0	0	75	2	0	0	0	2	2	57	0	0	59	0	0	0	0	0	0	136
08:00 AM	0	22	0	0	22	0	0	0	0	0	0	22	0	0	22	1	0	0	0	0	1	45
08:15 AM	1	19	0	0	20	0	0	0	0	0	0	13	0	0	13	1	0	0	0	0	1	34
08:30 AM	1	20	0	0	21	0	0	0	0	0	0	10	0	0	10	0	0	0	0	0	0	31
08:45 AM	2	14	0	0	16	0	0	0	0	0	0	12	0	0	12	0	0	0	0	0	0	28
Total	4	75	0	0	79	0	0	0	0	0	0	57	0	0	57	2	0	0	0	0	2	138
Grand Total	5	149	0	0	154	2	0	0	0	2	2	114	0	0	116	2	0	0	0	0	2	274
Apprch %	3.2	96.8	0	0		100	0	0	0		1.7	98.3	0	0		100	0	0	0			
Total %	1.8	54.4	0	0	56.2	0.7	0	0	0	0.7	0.7	41.6	0	0	42.3	0.7	0	0	0	0.7		

Start Time	US 29 Southbound				Terrace Greene Circle Westbound				US 29 Northbound				Business Ent/Exit Eastbound				Int. Total					
	Right	Thru	Left	App. Total	Right	Thru	Left	App. Total	Right	Thru	Left	App. Total	Right	Thru	Left	App. Total						
Peak Hour Analysis From 07:00 AM to 08:45 AM - Peak 1 of 1																						
Peak Hour for Entire Intersection Begins at 07:45 AM																						
07:45 AM	1	21	0	22	0	0	0	0	0	0	21	0	21	0	0	0	0	0	0	0	0	43
08:00 AM	0	22	0	22	0	0	0	0	0	0	22	0	22	1	0	0	0	0	0	1	0	45
08:15 AM	1	19	0	20	0	0	0	0	0	0	13	0	13	1	0	0	0	0	0	1	0	34
08:30 AM	1	20	0	21	0	0	0	0	0	0	10	0	10	0	0	0	0	0	0	0	0	31
Total Volume	3	82	0	85	0	0	0	0	0	0	66	0	66	2	0	0	0	0	2	0	0	153
% App. Total	3.5	96.5	0		0	0	0		0	0	100	0		100	0	0	0					
PHF	.750	.932	.000	.966	.000	.000	.000	.000	.000	.000	.750	.000	.750	.500	.000	.000	.500					.850

Peggy Malone & Associates, Inc.
(888) 247-8602

File Name : 1-US 29 (Seminole Trail) & Terrace Greene Circle AM
 Site Code :
 Start Date : 10/8/2020
 Page No : 1

Groups Printed- Combined

Start Time	US 29 Southbound					Terrace Greene Circle Westbound					US 29 Northbound					Business Ent/Exit Eastbound					Int. Total
	Right	Thru	Left	Peds	App. Total	Right	Thru	Left	Peds	App. Total	Right	Thru	Left	Peds	App. Total	Right	Thru	Left	Peds	App. Total	
07:00 AM	3	375	0	0	378	24	0	0	0	24	0	132	0	0	132	0	0	0	0	0	534
07:15 AM	0	418	0	0	418	23	0	0	0	23	1	142	0	0	143	0	0	0	0	0	584
07:30 AM	1	419	0	0	420	17	0	0	0	17	3	162	0	0	165	0	0	0	0	0	602
07:45 AM	2	379	0	0	381	18	0	0	0	18	5	185	0	0	190	1	0	0	0	1	590
Total	6	1591	0	0	1597	82	0	0	0	82	9	621	0	0	630	1	0	0	0	1	2310
08:00 AM	1	370	0	0	371	17	0	0	0	17	4	164	0	0	168	2	0	0	0	2	558
08:15 AM	1	334	0	0	335	7	0	0	1	8	1	166	0	0	167	1	0	0	0	1	511
08:30 AM	1	328	0	0	329	13	0	0	0	13	8	147	0	0	155	1	0	0	0	1	498
08:45 AM	3	244	0	0	247	9	0	0	0	9	3	170	0	0	173	1	0	0	0	1	430
Total	6	1276	0	0	1282	46	0	0	1	47	16	647	0	0	663	5	0	0	0	5	1997
Grand Total	12	2867	0	0	2879	128	0	0	1	129	25	1268	0	0	1293	6	0	0	0	6	4307
Apprch %	0.4	99.6	0	0		99.2	0	0	0.8		1.9	98.1	0	0		100	0	0	0		
Total %	0.3	66.6	0	0	66.8	3	0	0	0	3	0.6	29.4	0	0	30	0.1	0	0	0	0.1	

Start Time	US 29 Southbound				Terrace Greene Circle Westbound				US 29 Northbound				Business Ent/Exit Eastbound				Int. Total
	Right	Thru	Left	App. Total	Right	Thru	Left	App. Total	Right	Thru	Left	App. Total	Right	Thru	Left	App. Total	
Peak Hour Analysis From 07:00 AM to 08:45 AM - Peak 1 of 1																	
Peak Hour for Entire Intersection Begins at 07:15 AM																	
07:15 AM	0	418	0	418	23	0	0	23	1	142	0	143	0	0	0	0	584
07:30 AM	1	419	0	420	17	0	0	17	3	162	0	165	0	0	0	0	602
07:45 AM	2	379	0	381	18	0	0	18	5	185	0	190	1	0	0	1	590
08:00 AM	1	370	0	371	17	0	0	17	4	164	0	168	2	0	0	2	558
Total Volume	4	1586	0	1590	75	0	0	75	13	653	0	666	3	0	0	3	2334
% App. Total	0.3	99.7	0		100	0	0		2	98	0		100	0	0		
PHF	.500	.946	.000	.946	.815	.000	.000	.815	.650	.882	.000	.876	.375	.000	.000	.375	.969

Peggy Malone & Associates, Inc.
(888) 247-8602

File Name : 1-_US 29 (Seminole Trail) & Terrace Greene Circle PM
 Site Code :
 Start Date : 10/8/2020
 Page No : 1

Groups Printed- Cars

Start Time	US 29 Southbound					Terrace Greene Circle Westbound					US 29 Northbound					Business Ent/Exit Eastbound					Int. Total
	Right	Thru	Left	Peds	App. Total	Right	Thru	Left	Peds	App. Total	Right	Thru	Left	Peds	App. Total	Right	Thru	Left	Peds	App. Total	
04:00 PM	0	204	0	0	204	10	0	0	0	10	10	336	0	0	346	2	0	0	0	2	562
04:15 PM	0	232	0	0	232	10	0	0	0	10	10	306	0	0	316	1	0	0	0	1	559
04:30 PM	1	260	0	0	261	18	0	0	0	18	6	266	0	0	272	4	0	0	0	4	555
04:45 PM	0	241	0	0	241	16	0	0	0	16	9	311	0	0	320	0	0	0	0	0	577
Total	1	937	0	0	938	54	0	0	0	54	35	1219	0	0	1254	7	0	0	0	7	2253
05:00 PM	0	244	0	0	244	13	0	0	0	13	21	292	0	0	313	0	0	0	0	0	570
05:15 PM	0	229	0	0	229	9	0	0	0	9	26	412	0	0	438	0	0	0	0	0	676
05:30 PM	0	209	0	0	209	17	0	0	0	17	30	443	0	0	473	0	0	0	0	0	699
05:45 PM	0	255	0	0	255	18	0	0	0	18	31	459	0	0	490	0	0	0	0	0	763
Total	0	937	0	0	937	57	0	0	0	57	108	1606	0	0	1714	0	0	0	0	0	2708
Grand Total	1	1874	0	0	1875	111	0	0	0	111	143	2825	0	0	2968	7	0	0	0	7	4961
Apprch %	0.1	99.9	0	0		100	0	0	0		4.8	95.2	0	0		100	0	0	0		
Total %	0	37.8	0	0	37.8	2.2	0	0	0	2.2	2.9	56.9	0	0	59.8	0.1	0	0	0	0.1	

Start Time	US 29 Southbound				Terrace Greene Circle Westbound				US 29 Northbound				Business Ent/Exit Eastbound				Int. Total
	Right	Thru	Left	App. Total	Right	Thru	Left	App. Total	Right	Thru	Left	App. Total	Right	Thru	Left	App. Total	
Peak Hour Analysis From 04:00 PM to 05:45 PM - Peak 1 of 1																	
Peak Hour for Entire Intersection Begins at 05:00 PM																	
05:00 PM	0	244	0	244	13	0	0	13	21	292	0	313	0	0	0	0	570
05:15 PM	0	229	0	229	9	0	0	9	26	412	0	438	0	0	0	0	676
05:30 PM	0	209	0	209	17	0	0	17	30	443	0	473	0	0	0	0	699
05:45 PM	0	255	0	255	18	0	0	18	31	459	0	490	0	0	0	0	763
Total Volume	0	937	0	937	57	0	0	57	108	1606	0	1714	0	0	0	0	2708
% App. Total	0	100	0		100	0	0		6.3	93.7	0		0	0	0		
PHF	.000	.919	.000	.919	.792	.000	.000	.792	.871	.875	.000	.874	.000	.000	.000	.000	.887

Peggy Malone & Associates, Inc.
(888) 247-8602

File Name : 1-US 29 (Seminole Trail) & Terrace Greene Circle PM
 Site Code :
 Start Date : 10/8/2020
 Page No : 1

Groups Printed- Trucks

Start Time	US 29 Southbound					Terrance Greene Circle Westbound					US 29 Northbound					Business Ent/Exit Eastbound					Int. Total	
	Right	Thru	Left	Peds	App. Total	Right	Thru	Left	Peds	App. Total	Right	Thru	Left	Peds	App. Total	Right	Thru	Left	Peds	App. Total		
04:00 PM	0	16	0	0	16	1	0	0	0	1	0	17	0	0	17	0	0	0	0	0	0	34
04:15 PM	0	8	0	0	8	0	0	0	0	0	0	10	0	0	10	1	0	0	0	0	1	19
04:30 PM	0	8	0	0	8	1	0	0	0	1	0	10	0	0	10	0	0	0	0	0	0	19
04:45 PM	0	8	0	0	8	0	0	0	0	0	0	8	0	0	8	0	0	0	0	0	0	16
Total	0	40	0	0	40	2	0	0	0	2	0	45	0	0	45	1	0	0	0	0	1	88
05:00 PM	0	6	0	0	6	0	0	0	0	0	0	6	0	0	6	0	0	0	0	0	0	12
05:15 PM	0	6	0	0	6	0	0	0	0	0	0	14	0	0	14	0	0	0	0	0	0	20
05:30 PM	0	8	0	0	8	0	0	0	0	0	0	18	0	0	18	0	0	0	0	0	0	26
05:45 PM	0	6	0	0	6	0	0	0	0	0	0	6	0	0	6	0	0	0	0	0	0	12
Total	0	26	0	0	26	0	0	0	0	0	0	44	0	0	44	0	0	0	0	0	0	70
Grand Total	0	66	0	0	66	2	0	0	0	2	0	89	0	0	89	1	0	0	0	0	1	158
Apprch %	0	100	0	0		100	0	0	0		0	100	0	0		100	0	0	0	0		
Total %	0	41.8	0	0	41.8	1.3	0	0	0	1.3	0	56.3	0	0	56.3	0.6	0	0	0	0	0.6	

Start Time	US 29 Southbound				Terrance Greene Circle Westbound				US 29 Northbound				Business Ent/Exit Eastbound				Int. Total
	Right	Thru	Left	App. Total	Right	Thru	Left	App. Total	Right	Thru	Left	App. Total	Right	Thru	Left	App. Total	
Peak Hour Analysis From 04:00 PM to 05:45 PM - Peak 1 of 1																	
Peak Hour for Entire Intersection Begins at 04:00 PM																	
04:00 PM	0	16	0	16	1	0	0	1	0	17	0	17	0	0	0	0	34
04:15 PM	0	8	0	8	0	0	0	0	0	10	0	10	1	0	0	1	19
04:30 PM	0	8	0	8	1	0	0	1	0	10	0	10	0	0	0	0	19
04:45 PM	0	8	0	8	0	0	0	0	0	8	0	8	0	0	0	0	16
Total Volume	0	40	0	40	2	0	0	2	0	45	0	45	1	0	0	1	88
% App. Total	0	100	0		100	0	0		0	100	0		100	0	0		
PHF	.000	.625	.000	.625	.500	.000	.000	.500	.000	.662	.000	.662	.250	.000	.000	.250	.647

Peggy Malone & Associates, Inc.
(888) 247-8602

File Name : 1-US 29 (Seminole Trail) & Terrace Greene Circle PM
 Site Code :
 Start Date : 10/8/2020
 Page No : 1

Groups Printed- Combined

Start Time	US 29 Southbound					Terrace Greene Circle Westbound					US 29 Northbound					Business Ent/Exit Eastbound					Int. Total
	Right	Thru	Left	Peds	App. Total	Right	Thru	Left	Peds	App. Total	Right	Thru	Left	Peds	App. Total	Right	Thru	Left	Peds	App. Total	
04:00 PM	0	220	0	0	220	11	0	0	0	11	10	353	0	0	363	2	0	0	0	2	596
04:15 PM	0	240	0	0	240	10	0	0	0	10	10	316	0	0	326	2	0	0	0	2	578
04:30 PM	1	268	0	0	269	19	0	0	0	19	6	276	0	0	282	4	0	0	0	4	574
04:45 PM	0	249	0	0	249	16	0	0	0	16	9	319	0	0	328	0	0	0	0	0	593
Total	1	977	0	0	978	56	0	0	0	56	35	1264	0	0	1299	8	0	0	0	8	2341
05:00 PM	0	250	0	0	250	13	0	0	0	13	21	298	0	0	319	0	0	0	0	0	582
05:15 PM	0	235	0	0	235	9	0	0	0	9	26	426	0	0	452	0	0	0	0	0	696
05:30 PM	0	217	0	0	217	17	0	0	0	17	30	461	0	0	491	0	0	0	0	0	725
05:45 PM	0	261	0	0	261	18	0	0	0	18	31	465	0	0	496	0	0	0	0	0	775
Total	0	963	0	0	963	57	0	0	0	57	108	1650	0	0	1758	0	0	0	0	0	2778
Grand Total	1	1940	0	0	1941	113	0	0	0	113	143	2914	0	0	3057	8	0	0	0	8	5119
Apprch %	0.1	99.9	0	0		100	0	0	0		4.7	95.3	0	0		100	0	0	0		
Total %	0	37.9	0	0	37.9	2.2	0	0	0	2.2	2.8	56.9	0	0	59.7	0.2	0	0	0	0.2	

Start Time	US 29 Southbound				Terrace Greene Circle Westbound				US 29 Northbound				Business Ent/Exit Eastbound				Int. Total
	Right	Thru	Left	App. Total	Right	Thru	Left	App. Total	Right	Thru	Left	App. Total	Right	Thru	Left	App. Total	
Peak Hour Analysis From 04:00 PM to 05:45 PM - Peak 1 of 1																	
Peak Hour for Entire Intersection Begins at 05:00 PM																	
05:00 PM	0	250	0	250	13	0	0	13	21	298	0	319	0	0	0	0	582
05:15 PM	0	235	0	235	9	0	0	9	26	426	0	452	0	0	0	0	696
05:30 PM	0	217	0	217	17	0	0	17	30	461	0	491	0	0	0	0	725
05:45 PM	0	261	0	261	18	0	0	18	31	465	0	496	0	0	0	0	775
Total Volume	0	963	0	963	57	0	0	57	108	1650	0	1758	0	0	0	0	2778
% App. Total	0	100	0		100	0	0		6.1	93.9	0		0	0	0		
PHF	.000	.922	.000	.922	.792	.000	.000	.792	.871	.887	.000	.886	.000	.000	.000	.000	.896

Peggy Malone & Associates

(888) 247-8602

File Name : 1_US 29 & Keleigh Ln AM
 Site Code :
 Start Date : 4/14/2021
 Page No : 1

Groups Printed- Cars

Start Time	US 29 Southbound					Driveway Westbound					US 29 Northbound					Keleigh Ln Eastbound					Int. Total
	Right	Thru	Left	Peds	App. Total	Right	Thru	Left	Peds	App. Total	Right	Thru	Left	Peds	App. Total	Right	Thru	Left	Peds	App. Total	
07:00 AM	0	407	0	0	407	0	0	0	0	0	0	143	1	0	144	11	0	2	0	13	564
07:15 AM	2	445	0	0	447	0	0	0	0	0	0	124	3	0	127	7	0	4	0	11	585
07:30 AM	0	440	0	0	440	0	0	0	0	0	0	154	1	0	155	13	0	1	0	14	609
07:45 AM	1	354	0	0	355	0	0	0	0	0	0	149	1	0	150	7	0	5	0	12	517
Total	3	1646	0	0	1649	0	0	0	0	0	0	570	6	0	576	38	0	12	0	50	2275
08:00 AM	5	385	1	0	391	0	0	0	0	0	0	167	3	0	170	5	0	3	0	8	569
08:15 AM	3	356	0	0	359	0	0	0	0	0	0	153	0	0	153	4	0	0	0	4	516
08:30 AM	2	357	0	0	359	0	0	0	0	0	0	151	3	0	154	5	0	2	0	7	520
08:45 AM	1	289	1	0	291	0	0	0	0	0	0	165	1	0	166	8	0	0	0	8	465
Total	11	1387	2	0	1400	0	0	0	0	0	0	636	7	0	643	22	0	5	0	27	2070
Grand Total	14	3033	2	0	3049	0	0	0	0	0	0	1206	13	0	1219	60	0	17	0	77	4345
Apprch %	0.5	99.5	0.1	0		0	0	0	0		0	98.9	1.1	0		77.9	0	22.1	0		
Total %	0.3	69.8	0	0	70.2	0	0	0	0		0	27.8	0.3	0	28.1	1.4	0	0.4	0	1.8	

Start Time	US 29 Southbound				Driveway Westbound				US 29 Northbound				Keleigh Ln Eastbound				Int. Total	
	Right	Thru	Left	App. Total	Right	Thru	Left	App. Total	Right	Thru	Left	App. Total	Right	Thru	Left	App. Total		
Peak Hour Analysis From 07:00 AM to 08:45 AM - Peak 1 of 1																		
Peak Hour for Entire Intersection Begins at 07:15 AM																		
07:15 AM	2	445	0	447	0	0	0	0	0	0	124	3	127	7	0	4	11	585
07:30 AM	0	440	0	440	0	0	0	0	0	0	154	1	155	13	0	1	14	609
07:45 AM	1	354	0	355	0	0	0	0	0	0	149	1	150	7	0	5	12	517
08:00 AM	5	385	1	391	0	0	0	0	0	0	167	3	170	5	0	3	8	569
Total Volume	8	1624	1	1633	0	0	0	0	0	0	594	8	602	32	0	13	45	2280
% App. Total	0.5	99.4	0.1		0	0	0		0	0	98.7	1.3		71.1	0	28.9		
PHF	.400	.912	.250	.913	.000	.000	.000	.000	.000	.000	.889	.667	.885	.615	.000	.650	.804	.936

Peggy Malone & Associates

(888) 247-8602

File Name : 1_US 29 & Keleigh Ln AM
 Site Code :
 Start Date : 4/14/2021
 Page No : 1

Groups Printed- Trucks

Start Time	US 29 Southbound					Driveway Westbound					US 29 Northbound					Keleigh Ln Eastbound					Int. Total
	Right	Thru	Left	Peds	App. Total	Right	Thru	Left	Peds	App. Total	Right	Thru	Left	Peds	App. Total	Right	Thru	Left	Peds	App. Total	
07:00 AM	1	15	0	0	16	0	0	0	0	0	0	16	0	0	16	1	0	0	0	1	33
07:15 AM	1	16	0	0	17	0	0	0	0	0	0	25	0	0	25	1	0	0	0	1	43
07:30 AM	0	17	0	0	17	0	0	0	0	0	0	15	0	0	15	0	0	0	0	0	32
07:45 AM	0	28	0	0	28	0	0	0	0	0	0	16	1	0	17	0	0	0	0	0	45
Total	2	76	0	0	78	0	0	0	0	0	0	72	1	0	73	2	0	0	0	2	153
08:00 AM	0	17	0	0	17	0	0	0	0	0	0	20	0	0	20	0	0	0	0	0	37
08:15 AM	0	16	0	0	16	0	0	0	0	0	0	19	0	0	19	0	0	0	0	0	35
08:30 AM	0	18	0	0	18	0	0	0	0	0	0	16	0	0	16	0	0	0	0	0	34
08:45 AM	0	24	0	0	24	0	0	0	0	0	0	16	0	0	16	0	0	0	0	0	40
Total	0	75	0	0	75	0	0	0	0	0	0	71	0	0	71	0	0	0	0	0	146
Grand Total	2	151	0	0	153	0	0	0	0	0	0	143	1	0	144	2	0	0	0	2	299
Apprch %	1.3	98.7	0	0		0	0	0	0		0	99.3	0.7	0		100	0	0	0		
Total %	0.7	50.5	0	0	51.2	0	0	0	0	0	0	47.8	0.3	0	48.2	0.7	0	0	0	0.7	

Start Time	US 29 Southbound				Driveway Westbound				US 29 Northbound				Keleigh Ln Eastbound				Int. Total	
	Right	Thru	Left	App. Total	Right	Thru	Left	App. Total	Right	Thru	Left	App. Total	Right	Thru	Left	App. Total		
Peak Hour Analysis From 07:00 AM to 08:45 AM - Peak 1 of 1																		
Peak Hour for Entire Intersection Begins at 07:15 AM																		
07:15 AM	1	16	0	17	0	0	0	0	0	0	25	0	25	1	0	0	1	43
07:30 AM	0	17	0	17	0	0	0	0	0	0	15	0	15	0	0	0	0	32
07:45 AM	0	28	0	28	0	0	0	0	0	0	16	1	17	0	0	0	0	45
08:00 AM	0	17	0	17	0	0	0	0	0	0	20	0	20	0	0	0	0	37
Total Volume	1	78	0	79	0	0	0	0	0	0	76	1	77	1	0	0	1	157
% App. Total	1.3	98.7	0		0	0	0		0	0	98.7	1.3		100	0	0		
PHF	.250	.696	.000	.705	.000	.000	.000	.000	.000	.000	.760	.250	.770	.250	.000	.000	.250	.872

Peggy Malone & Associates

(888) 247-8602

File Name : 1_US 29 & Keleigh Ln AM
 Site Code :
 Start Date : 4/14/2021
 Page No : 1

Groups Printed- Combined

Start Time	US 29 Southbound					Driveway Westbound					US 29 Northbound					Keleigh Ln Eastbound					Int. Total
	Right	Thru	Left	Peds	App. Total	Right	Thru	Left	Peds	App. Total	Right	Thru	Left	Peds	App. Total	Right	Thru	Left	Peds	App. Total	
07:00 AM	1	422	0	0	423	0	0	0	0	0	0	159	1	0	160	12	0	2	0	14	597
07:15 AM	3	461	0	0	464	0	0	0	0	0	0	149	3	0	152	8	0	4	0	12	628
07:30 AM	0	457	0	0	457	0	0	0	0	0	0	169	1	0	170	13	0	1	0	14	641
07:45 AM	1	382	0	0	383	0	0	0	0	0	0	165	2	0	167	7	0	5	0	12	562
Total	5	1722	0	0	1727	0	0	0	0	0	0	642	7	0	649	40	0	12	0	52	2428
08:00 AM	5	402	1	0	408	0	0	0	0	0	0	187	3	0	190	5	0	3	0	8	606
08:15 AM	3	372	0	0	375	0	0	0	0	0	0	172	0	0	172	4	0	0	0	4	551
08:30 AM	2	375	0	0	377	0	0	0	0	0	0	167	3	0	170	5	0	2	0	7	554
08:45 AM	1	313	1	0	315	0	0	0	0	0	0	181	1	0	182	8	0	0	0	8	505
Total	11	1462	2	0	1475	0	0	0	0	0	0	707	7	0	714	22	0	5	0	27	2216
Grand Total	16	3184	2	0	3202	0	0	0	0	0	0	1349	14	0	1363	62	0	17	0	79	4644
Apprch %	0.5	99.4	0.1	0		0	0	0	0		0	99	1	0		78.5	0	21.5	0		
Total %	0.3	68.6	0	0	68.9	0	0	0	0	0	0	29	0.3	0	29.3	1.3	0	0.4	0	1.7	

Start Time	US 29 Southbound				Driveway Westbound				US 29 Northbound				Keleigh Ln Eastbound				Int. Total	
	Right	Thru	Left	App. Total	Right	Thru	Left	App. Total	Right	Thru	Left	App. Total	Right	Thru	Left	App. Total		
Peak Hour Analysis From 07:00 AM to 08:45 AM - Peak 1 of 1																		
Peak Hour for Entire Intersection Begins at 07:15 AM																		
07:15 AM	3	461	0	464	0	0	0	0	0	0	149	3	152	8	0	4	12	628
07:30 AM	0	457	0	457	0	0	0	0	0	0	169	1	170	13	0	1	14	641
07:45 AM	1	382	0	383	0	0	0	0	0	0	165	2	167	7	0	5	12	562
08:00 AM	5	402	1	408	0	0	0	0	0	0	187	3	190	5	0	3	8	606
Total Volume	9	1702	1	1712	0	0	0	0	0	0	670	9	679	33	0	13	46	2437
% App. Total	0.5	99.4	0.1		0	0	0		0	0	98.7	1.3		71.7	0	28.3		
PHF	.450	.923	.250	.922	.000	.000	.000	.000	.000	.000	.896	.750	.893	.635	.000	.650	.821	.950

Peggy Malone & Associates

(888) 247-8602

File Name : 1_US 29 & Keleigh Ln PM
 Site Code :
 Start Date : 4/14/2021
 Page No : 1

Groups Printed- Cars

Start Time	US 29 Southbound					Driveway Westbound					US 29 Northbound					Keleigh Ln Eastbound					Int. Total
	Right	Thru	Left	Peds	App. Total	Right	Thru	Left	Peds	App. Total	Right	Thru	Left	Peds	App. Total	Right	Thru	Left	Peds	App. Total	
04:00 PM	1	211	0	0	212	0	0	0	0	0	0	369	6	0	375	2	0	2	0	4	591
04:15 PM	0	199	1	0	200	0	0	0	0	0	0	419	3	0	422	2	0	2	0	4	626
04:30 PM	2	265	1	0	268	0	0	0	0	0	0	430	6	0	436	3	0	4	0	7	711
04:45 PM	3	218	2	0	223	0	0	0	0	0	0	445	4	0	449	2	0	1	0	3	675
Total	6	893	4	0	903	0	0	0	0	0	0	1663	19	0	1682	9	0	9	0	18	2603
05:00 PM	8	223	0	0	231	0	0	0	0	0	0	445	5	0	450	4	0	4	0	8	689
05:15 PM	4	205	0	0	209	0	0	0	0	0	0	442	11	0	453	1	0	2	0	3	665
05:30 PM	1	225	1	0	227	0	0	0	0	0	0	452	10	0	462	6	0	5	0	11	700
05:45 PM	6	206	0	0	212	0	0	0	0	0	0	403	9	0	412	5	0	0	0	5	629
Total	19	859	1	0	879	0	0	0	0	0	0	1742	35	0	1777	16	0	11	0	27	2683
Grand Total	25	1752	5	0	1782	0	0	0	0	0	0	3405	54	0	3459	25	0	20	0	45	5286
Apprch %	1.4	98.3	0.3	0		0	0	0	0		0	98.4	1.6	0		55.6	0	44.4	0		
Total %	0.5	33.1	0.1	0	33.7	0	0	0	0	0	0	64.4	1	0	65.4	0.5	0	0.4	0	0.9	

Start Time	US 29 Southbound				Driveway Westbound				US 29 Northbound				Keleigh Ln Eastbound				Int. Total
	Right	Thru	Left	App. Total	Right	Thru	Left	App. Total	Right	Thru	Left	App. Total	Right	Thru	Left	App. Total	
Peak Hour Analysis From 04:00 PM to 05:45 PM - Peak 1 of 1																	
Peak Hour for Entire Intersection Begins at 04:30 PM																	
04:30 PM	2	265	1	268	0	0	0	0	0	430	6	436	3	0	4	7	711
04:45 PM	3	218	2	223	0	0	0	0	0	445	4	449	2	0	1	3	675
05:00 PM	8	223	0	231	0	0	0	0	0	445	5	450	4	0	4	8	689
05:15 PM	4	205	0	209	0	0	0	0	0	442	11	453	1	0	2	3	665
Total Volume	17	911	3	931	0	0	0	0	0	1762	26	1788	10	0	11	21	2740
% App. Total	1.8	97.9	0.3		0	0	0		0	98.5	1.5		47.6	0	52.4		
PHF	.531	.859	.375	.868	.000	.000	.000	.000	.000	.990	.591	.987	.625	.000	.688	.656	.963

Peggy Malone & Associates

(888) 247-8602

File Name : 1_US 29 & Keleigh Ln PM
 Site Code :
 Start Date : 4/14/2021
 Page No : 1

Groups Printed- Combined

Start Time	US 29 Southbound					Driveway Westbound					US 29 Northbound					Keleigh Ln Eastbound					Int. Total
	Right	Thru	Left	Peds	App. Total	Right	Thru	Left	Peds	App. Total	Right	Thru	Left	Peds	App. Total	Right	Thru	Left	Peds	App. Total	
04:00 PM	1	224	0	0	225	0	0	0	0	0	0	384	6	0	390	2	0	2	0	4	619
04:15 PM	0	211	1	0	212	0	0	0	0	0	0	432	3	0	435	2	0	2	0	4	651
04:30 PM	2	274	1	0	277	0	0	0	0	0	0	441	6	0	447	3	0	4	0	7	731
04:45 PM	3	230	2	0	235	0	0	0	0	0	0	454	4	0	458	2	0	1	0	3	696
Total	6	939	4	0	949	0	0	0	0	0	0	1711	19	0	1730	9	0	9	0	18	2697
05:00 PM	8	228	0	0	236	0	0	0	0	0	0	453	5	0	458	4	0	4	0	8	702
05:15 PM	4	210	0	0	214	0	0	0	0	0	0	451	11	0	462	1	0	2	0	3	679
05:30 PM	1	231	1	0	233	0	0	0	0	0	0	462	10	0	472	6	0	5	0	11	716
05:45 PM	6	209	0	0	215	0	0	0	0	0	0	409	9	0	418	5	0	0	0	5	638
Total	19	878	1	0	898	0	0	0	0	0	0	1775	35	0	1810	16	0	11	0	27	2735
Grand Total	25	1817	5	0	1847	0	0	0	0	0	0	3486	54	0	3540	25	0	20	0	45	5432
Apprch %	1.4	98.4	0.3	0		0	0	0	0	0	0	98.5	1.5	0		55.6	0	44.4	0		
Total %	0.5	33.4	0.1	0	34	0	0	0	0	0	0	64.2	1	0	65.2	0.5	0	0.4	0	0.8	

Start Time	US 29 Southbound				Driveway Westbound				US 29 Northbound				Keleigh Ln Eastbound				Int. Total
	Right	Thru	Left	App. Total	Right	Thru	Left	App. Total	Right	Thru	Left	App. Total	Right	Thru	Left	App. Total	
Peak Hour Analysis From 04:00 PM to 05:45 PM - Peak 1 of 1																	
Peak Hour for Entire Intersection Begins at 04:30 PM																	
04:30 PM	2	274	1	277	0	0	0	0	0	441	6	447	3	0	4	7	731
04:45 PM	3	230	2	235	0	0	0	0	0	454	4	458	2	0	1	3	696
05:00 PM	8	228	0	236	0	0	0	0	0	453	5	458	4	0	4	8	702
05:15 PM	4	210	0	214	0	0	0	0	0	451	11	462	1	0	2	3	679
Total Volume	17	942	3	962	0	0	0	0	0	1799	26	1825	10	0	11	21	2808
% App. Total	1.8	97.9	0.3		0	0	0		0	98.6	1.4		47.6	0	52.4		
PHF	.531	.859	.375	.868	.000	.000	.000	.000	.000	.991	.591	.988	.625	.000	.688	.656	.960

Peggy Malone & Associates

(888) 247-8602

File Name : 2_US 29 & Commercial Ent. AM
 Site Code :
 Start Date : 4/14/2021
 Page No : 1

Groups Printed- Cars

Start Time	US 29 Southbound				Commercial Ent Westbound				US 29 Northbound				Int. Total	
	Thru	Left	Peds	App. Total	Right	Left	Peds	App. Total	Right	Thru	Left	Peds		App. Total
07:00 AM	389	16	0	405	4	12	0	16	2	141	5	0	148	569
07:15 AM	433	19	0	452	7	17	0	24	8	111	5	0	124	600
07:30 AM	435	17	0	452	8	15	0	23	8	151	8	0	167	642
07:45 AM	351	21	0	372	13	11	0	24	7	137	4	0	148	544
Total	1608	73	0	1681	32	55	0	87	25	540	22	0	587	2355
08:00 AM	356	27	0	383	11	14	0	25	3	145	5	0	153	561
08:15 AM	335	18	0	353	8	11	0	19	2	138	6	0	146	518
08:30 AM	336	12	0	348	10	9	0	19	7	139	6	0	152	519
08:45 AM	280	17	0	297	13	4	0	17	6	154	3	0	163	477
Total	1307	74	0	1381	42	38	0	80	18	576	20	0	614	2075
Grand Total	2915	147	0	3062	74	93	0	167	43	1116	42	0	1201	4430
Apprch %	95.2	4.8	0		44.3	55.7	0		3.6	92.9	3.5	0		
Total %	65.8	3.3	0	69.1	1.7	2.1	0	3.8	1	25.2	0.9	0	27.1	

Start Time	US 29 Southbound			Commercial Ent Westbound			US 29 Northbound			Int. Total	
	Thru	Left	App. Total	Right	Left	App. Total	Right	Thru	Left		App. Total
Peak Hour Analysis From 07:00 AM to 08:45 AM - Peak 1 of 1											
Peak Hour for Entire Intersection Begins at 07:00 AM											
07:00 AM	389	16	405	4	12	16	2	141	5	148	569
07:15 AM	433	19	452	7	17	24	8	111	5	124	600
07:30 AM	435	17	452	8	15	23	8	151	8	167	642
07:45 AM	351	21	372	13	11	24	7	137	4	148	544
Total Volume	1608	73	1681	32	55	87	25	540	22	587	2355
% App. Total	95.7	4.3		36.8	63.2		4.3	92	3.7		
PHF	.924	.869	.930	.615	.809	.906	.781	.894	.688	.879	.917

Peggy Malone & Associates

(888) 247-8602

File Name : 2_US 29 & Commercial Ent. AM
 Site Code :
 Start Date : 4/14/2021
 Page No : 1

Groups Printed- Trucks

Start Time	US 29 Southbound				Commercial Ent Westbound				US 29 Northbound				Int. Total	
	Thru	Left	Peds	App. Total	Right	Left	Peds	App. Total	Right	Thru	Left	Peds		App. Total
07:00 AM	17	0	0	17	0	0	0	0	0	15	0	0	15	32
07:15 AM	14	1	0	15	0	0	0	0	1	24	0	0	25	40
07:30 AM	19	0	0	19	1	0	0	1	0	13	0	0	13	33
07:45 AM	27	1	0	28	0	0	0	0	0	15	0	0	15	43
Total	77	2	0	79	1	0	0	1	1	67	0	0	68	148
08:00 AM	17	0	0	17	0	0	0	0	0	22	0	0	22	39
08:15 AM	17	0	0	17	0	0	0	0	0	19	0	0	19	36
08:30 AM	16	1	0	17	0	0	0	0	0	15	0	0	15	32
08:45 AM	23	0	0	23	0	0	0	0	0	17	0	0	17	40
Total	73	1	0	74	0	0	0	0	0	73	0	0	73	147
Grand Total	150	3	0	153	1	0	0	1	1	140	0	0	141	295
Apprch %	98	2	0		100	0	0		0.7	99.3	0	0		
Total %	50.8	1	0	51.9	0.3	0	0	0.3	0.3	47.5	0	0	47.8	

Start Time	US 29 Southbound			Commercial Ent Westbound			US 29 Northbound			Int. Total	
	Thru	Left	App. Total	Right	Left	App. Total	Right	Thru	Left		App. Total
Peak Hour Analysis From 07:00 AM to 08:45 AM - Peak 1 of 1											
Peak Hour for Entire Intersection Begins at 07:15 AM											
07:15 AM	14	1	15	0	0	0	1	24	0	25	40
07:30 AM	19	0	19	1	0	1	0	13	0	13	33
07:45 AM	27	1	28	0	0	0	0	15	0	15	43
08:00 AM	17	0	17	0	0	0	0	22	0	22	39
Total Volume	77	2	79	1	0	1	1	74	0	75	155
% App. Total	97.5	2.5		100	0		1.3	98.7	0		
PHF	.713	.500	.705	.250	.000	.250	.250	.771	.000	.750	.901

Peggy Malone & Associates

(888) 247-8602

File Name : 2_US 29 & Commercial Ent. AM
 Site Code :
 Start Date : 4/14/2021
 Page No : 1

Groups Printed- Combined

Start Time	US 29 Southbound				Commercial Ent Westbound				US 29 Northbound				Int. Total	
	Thru	Left	Peds	App. Total	Right	Left	Peds	App. Total	Right	Thru	Left	Peds		App. Total
07:00 AM	406	16	0	422	4	12	0	16	2	156	5	0	163	601
07:15 AM	447	20	0	467	7	17	0	24	9	135	5	0	149	640
07:30 AM	454	17	0	471	9	15	0	24	8	164	8	0	180	675
07:45 AM	378	22	0	400	13	11	0	24	7	152	4	0	163	587
Total	1685	75	0	1760	33	55	0	88	26	607	22	0	655	2503
08:00 AM	373	27	0	400	11	14	0	25	3	167	5	0	175	600
08:15 AM	352	18	0	370	8	11	0	19	2	157	6	0	165	554
08:30 AM	352	13	0	365	10	9	0	19	7	154	6	0	167	551
08:45 AM	303	17	0	320	13	4	0	17	6	171	3	0	180	517
Total	1380	75	0	1455	42	38	0	80	18	649	20	0	687	2222
Grand Total	3065	150	0	3215	75	93	0	168	44	1256	42	0	1342	4725
Apprch %	95.3	4.7	0		44.6	55.4	0		3.3	93.6	3.1	0		
Total %	64.9	3.2	0	68	1.6	2	0	3.6	0.9	26.6	0.9	0	28.4	

Start Time	US 29 Southbound			Commercial Ent Westbound			US 29 Northbound			Int. Total	
	Thru	Left	App. Total	Right	Left	App. Total	Right	Thru	Left		App. Total
Peak Hour Analysis From 07:00 AM to 08:45 AM - Peak 1 of 1											
Peak Hour for Entire Intersection Begins at 07:00 AM											
07:00 AM	406	16	422	4	12	16	2	156	5	163	601
07:15 AM	447	20	467	7	17	24	9	135	5	149	640
07:30 AM	454	17	471	9	15	24	8	164	8	180	675
07:45 AM	378	22	400	13	11	24	7	152	4	163	587
Total Volume	1685	75	1760	33	55	88	26	607	22	655	2503
% App. Total	95.7	4.3		37.5	62.5		4	92.7	3.4		
PHF	.928	.852	.934	.635	.809	.917	.722	.925	.688	.910	.927

Peggy Malone & Associates

(888) 247-8602

File Name : 2_US 29 & Commercial Ent. PM
 Site Code :
 Start Date : 4/14/2021
 Page No : 1

Groups Printed- Cars

Start Time	US 29 Southbound				Commercial Ent Westbound				US 29 Northbound				Int. Total	
	Thru	Left	Peds	App. Total	Right	Left	Peds	App. Total	Right	Thru	Left	Peds		App. Total
04:00 PM	197	14	0	211	9	2	0	11	6	343	4	0	353	575
04:15 PM	196	15	0	211	5	5	0	10	8	410	2	0	420	641
04:30 PM	253	10	0	263	10	2	0	12	5	419	4	0	428	703
04:45 PM	211	19	0	230	8	0	0	8	9	441	3	0	453	691
Total	857	58	0	915	32	9	0	41	28	1613	13	0	1654	2610
05:00 PM	197	19	0	216	15	0	0	15	9	410	2	0	421	652
05:15 PM	201	16	0	217	11	1	0	12	6	449	2	0	457	686
05:30 PM	208	11	0	219	12	5	0	17	5	429	5	0	439	675
05:45 PM	205	10	0	215	11	2	0	13	4	399	6	0	409	637
Total	811	56	0	867	49	8	0	57	24	1687	15	0	1726	2650
Grand Total	1668	114	0	1782	81	17	0	98	52	3300	28	0	3380	5260
Apprch %	93.6	6.4	0		82.7	17.3	0		1.5	97.6	0.8	0		
Total %	31.7	2.2	0	33.9	1.5	0.3	0	1.9	1	62.7	0.5	0	64.3	

Start Time	US 29 Southbound			Commercial Ent Westbound			US 29 Northbound			Int. Total	
	Thru	Left	App. Total	Right	Left	App. Total	Right	Thru	Left		App. Total
Peak Hour Analysis From 04:00 PM to 05:45 PM - Peak 1 of 1											
Peak Hour for Entire Intersection Begins at 04:30 PM											
04:30 PM	253	10	263	10	2	12	5	419	4	428	703
04:45 PM	211	19	230	8	0	8	9	441	3	453	691
05:00 PM	197	19	216	15	0	15	9	410	2	421	652
05:15 PM	201	16	217	11	1	12	6	449	2	457	686
Total Volume	862	64	926	44	3	47	29	1719	11	1759	2732
% App. Total	93.1	6.9		93.6	6.4		1.6	97.7	0.6		
PHF	.852	.842	.880	.733	.375	.783	.806	.957	.688	.962	.972

Peggy Malone & Associates

(888) 247-8602

File Name : 2_US 29 & Commercial Ent. PM
 Site Code :
 Start Date : 4/14/2021
 Page No : 1

Groups Printed- Trucks

Start Time	US 29 Southbound				Commercial Ent Westbound				US 29 Northbound				Int. Total	
	Thru	Left	Peds	App. Total	Right	Left	Peds	App. Total	Right	Thru	Left	Peds		App. Total
04:00 PM	12	0	0	12	0	0	0	0	0	15	0	0	15	27
04:15 PM	14	0	0	14	0	0	0	0	0	11	0	0	11	25
04:30 PM	10	0	0	10	0	0	0	0	0	11	0	0	11	21
04:45 PM	11	1	0	12	0	0	0	0	0	9	0	0	9	21
Total	47	1	0	48	0	0	0	0	0	46	0	0	46	94
05:00 PM	4	0	0	4	0	0	0	0	0	8	0	0	8	12
05:15 PM	6	0	0	6	0	0	0	0	0	8	0	0	8	14
05:30 PM	6	0	0	6	0	0	0	0	0	11	0	0	11	17
05:45 PM	4	0	0	4	0	0	0	0	0	6	0	0	6	10
Total	20	0	0	20	0	0	0	0	0	33	0	0	33	53
Grand Total	67	1	0	68	0	0	0	0	0	79	0	0	79	147
Apprch %	98.5	1.5	0		0	0	0	0	0	100	0	0		
Total %	45.6	0.7	0	46.3	0	0	0	0	0	53.7	0	0	53.7	

Start Time	US 29 Southbound			Commercial Ent Westbound			US 29 Northbound			Int. Total	
	Thru	Left	App. Total	Right	Left	App. Total	Right	Thru	Left		App. Total
Peak Hour Analysis From 04:00 PM to 05:45 PM - Peak 1 of 1											
Peak Hour for Entire Intersection Begins at 04:00 PM											
04:00 PM	12	0	12	0	0	0	0	15	0	15	27
04:15 PM	14	0	14	0	0	0	0	11	0	11	25
04:30 PM	10	0	10	0	0	0	0	11	0	11	21
04:45 PM	11	1	12	0	0	0	0	9	0	9	21
Total Volume	47	1	48	0	0	0	0	46	0	46	94
% App. Total	97.9	2.1		0	0		0	100	0		
PHF	.839	.250	.857	.000	.000	.000	.000	.767	.000	.767	.870

Peggy Malone & Associates

(888) 247-8602

File Name : 2_US 29 & Commercial Ent. PM
 Site Code :
 Start Date : 4/14/2021
 Page No : 1

Groups Printed- Combined

Start Time	US 29 Southbound				Commercial Ent Westbound				US 29 Northbound				Int. Total	
	Thru	Left	Peds	App. Total	Right	Left	Peds	App. Total	Right	Thru	Left	Peds		App. Total
04:00 PM	209	14	0	223	9	2	0	11	6	358	4	0	368	602
04:15 PM	210	15	0	225	5	5	0	10	8	421	2	0	431	666
04:30 PM	263	10	0	273	10	2	0	12	5	430	4	0	439	724
04:45 PM	222	20	0	242	8	0	0	8	9	450	3	0	462	712
Total	904	59	0	963	32	9	0	41	28	1659	13	0	1700	2704
05:00 PM	201	19	0	220	15	0	0	15	9	418	2	0	429	664
05:15 PM	207	16	0	223	11	1	0	12	6	457	2	0	465	700
05:30 PM	214	11	0	225	12	5	0	17	5	440	5	0	450	692
05:45 PM	209	10	0	219	11	2	0	13	4	405	6	0	415	647
Total	831	56	0	887	49	8	0	57	24	1720	15	0	1759	2703
Grand Total	1735	115	0	1850	81	17	0	98	52	3379	28	0	3459	5407
Apprch %	93.8	6.2	0		82.7	17.3	0		1.5	97.7	0.8	0		
Total %	32.1	2.1	0	34.2	1.5	0.3	0	1.8	1	62.5	0.5	0	64	

Start Time	US 29 Southbound			Commercial Ent Westbound			US 29 Northbound			Int. Total	
	Thru	Left	App. Total	Right	Left	App. Total	Right	Thru	Left		App. Total
Peak Hour Analysis From 04:00 PM to 05:45 PM - Peak 1 of 1											
Peak Hour for Entire Intersection Begins at 04:30 PM											
04:30 PM	263	10	273	10	2	12	5	430	4	439	724
04:45 PM	222	20	242	8	0	8	9	450	3	462	712
05:00 PM	201	19	220	15	0	15	9	418	2	429	664
05:15 PM	207	16	223	11	1	12	6	457	2	465	700
Total Volume	893	65	958	44	3	47	29	1755	11	1795	2800
% App. Total	93.2	6.8		93.6	6.4		1.6	97.8	0.6		
PHF	.849	.813	.877	.733	.375	.783	.806	.960	.688	.965	.967

Peggy Malone & Associates

(888) 247-8602

File Name : 3_US 29 & Lake Saponi Dr AM
 Site Code :
 Start Date : 4/14/2021
 Page No : 1

Groups Printed- Cars

Start Time	US 29 Southbound				Lake Saponi Dr Westbound				US 29 Northbound				Int. Total
	Thru	Left	Peds	App. Total	Right	Left	Peds	App. Total	Right	Thru	Peds	App. Total	
07:00 AM	405	0	0	405	10	0	0	10	1	136	0	137	552
07:15 AM	445	0	0	445	13	0	0	13	4	114	0	118	576
07:30 AM	462	0	0	462	9	0	0	9	3	153	0	156	627
07:45 AM	370	0	0	370	6	0	0	6	5	138	0	143	519
Total	1682	0	0	1682	38	0	0	38	13	541	0	554	2274
08:00 AM	376	0	0	376	11	0	0	11	7	141	0	148	535
08:15 AM	352	0	0	352	11	0	0	11	8	135	0	143	506
08:30 AM	352	0	0	352	9	0	0	9	4	144	0	148	509
08:45 AM	291	0	0	291	5	0	0	5	3	151	0	154	450
Total	1371	0	0	1371	36	0	0	36	22	571	0	593	2000
Grand Total	3053	0	0	3053	74	0	0	74	35	1112	0	1147	4274
Apprch %	100	0	0		100	0	0		3.1	96.9	0		
Total %	71.4	0	0	71.4	1.7	0	0	1.7	0.8	26	0	26.8	

Start Time	US 29 Southbound			Lake Saponi Dr Westbound			US 29 Northbound			Int. Total
	Thru	Left	App. Total	Right	Left	App. Total	Right	Thru	App. Total	
Peak Hour Analysis From 07:00 AM to 08:45 AM - Peak 1 of 1										
Peak Hour for Entire Intersection Begins at 07:00 AM										
07:00 AM	405	0	405	10	0	10	1	136	137	552
07:15 AM	445	0	445	13	0	13	4	114	118	576
07:30 AM	462	0	462	9	0	9	3	153	156	627
07:45 AM	370	0	370	6	0	6	5	138	143	519
Total Volume	1682	0	1682	38	0	38	13	541	554	2274
% App. Total	100	0		100	0		2.3	97.7		
PHF	.910	.000	.910	.731	.000	.731	.650	.884	.888	.907

Peggy Malone & Associates

(888) 247-8602

File Name : 3_US 29 & Lake Saponi Dr AM
 Site Code :
 Start Date : 4/14/2021
 Page No : 1

Groups Printed- Trucks

Start Time	US 29 Southbound				Lake Saponi Dr Westbound				US 29 Northbound				Int. Total
	Thru	Left	Peds	App. Total	Right	Left	Peds	App. Total	Right	Thru	Peds	App. Total	
07:00 AM	17	0	0	17	0	0	0	0	2	15	0	17	34
07:15 AM	16	0	0	16	0	0	0	0	1	24	0	25	41
07:30 AM	17	0	0	17	1	0	0	1	0	14	0	14	32
07:45 AM	27	0	0	27	2	0	0	2	1	11	0	12	41
Total	77	0	0	77	3	0	0	3	4	64	0	68	148
08:00 AM	17	0	0	17	0	0	0	0	0	21	0	21	38
08:15 AM	18	0	0	18	0	0	0	0	0	18	0	18	36
08:30 AM	16	0	0	16	0	0	0	0	0	15	0	15	31
08:45 AM	23	0	0	23	1	0	0	1	1	16	0	17	41
Total	74	0	0	74	1	0	0	1	1	70	0	71	146
Grand Total	151	0	0	151	4	0	0	4	5	134	0	139	294
Apprch %	100	0	0		100	0	0		3.6	96.4	0		
Total %	51.4	0	0	51.4	1.4	0	0	1.4	1.7	45.6	0	47.3	

Start Time	US 29 Southbound			Lake Saponi Dr Westbound			US 29 Northbound			Int. Total
	Thru	Left	App. Total	Right	Left	App. Total	Right	Thru	App. Total	
Peak Hour Analysis From 07:00 AM to 08:45 AM - Peak 1 of 1										
Peak Hour for Entire Intersection Begins at 07:15 AM										
07:15 AM	16	0	16	0	0	0	1	24	25	41
07:30 AM	17	0	17	1	0	1	0	14	14	32
07:45 AM	27	0	27	2	0	2	1	11	12	41
08:00 AM	17	0	17	0	0	0	0	21	21	38
Total Volume	77	0	77	3	0	3	2	70	72	152
% App. Total	100	0		100	0		2.8	97.2		
PHF	.713	.000	.713	.375	.000	.375	.500	.729	.720	.927

Peggy Malone & Associates

(888) 247-8602

File Name : 3_US 29 & Lake Saponi Dr AM
 Site Code :
 Start Date : 4/14/2021
 Page No : 1

Groups Printed- Combined

Start Time	US 29 Southbound				Lake Saponi Dr Westbound				US 29 Northbound				Int. Total
	Thru	Left	Peds	App. Total	Right	Left	Peds	App. Total	Right	Thru	Peds	App. Total	
07:00 AM	422	0	0	422	10	0	0	10	3	151	0	154	586
07:15 AM	461	0	0	461	13	0	0	13	5	138	0	143	617
07:30 AM	479	0	0	479	10	0	0	10	3	167	0	170	659
07:45 AM	397	0	0	397	8	0	0	8	6	149	0	155	560
Total	1759	0	0	1759	41	0	0	41	17	605	0	622	2422
08:00 AM	393	0	0	393	11	0	0	11	7	162	0	169	573
08:15 AM	370	0	0	370	11	0	0	11	8	153	0	161	542
08:30 AM	368	0	0	368	9	0	0	9	4	159	0	163	540
08:45 AM	314	0	0	314	6	0	0	6	4	167	0	171	491
Total	1445	0	0	1445	37	0	0	37	23	641	0	664	2146
Grand Total	3204	0	0	3204	78	0	0	78	40	1246	0	1286	4568
Apprch %	100	0	0		100	0	0		3.1	96.9	0		
Total %	70.1	0	0	70.1	1.7	0	0	1.7	0.9	27.3	0	28.2	

Start Time	US 29 Southbound			Lake Saponi Dr Westbound			US 29 Northbound			Int. Total
	Thru	Left	App. Total	Right	Left	App. Total	Right	Thru	App. Total	
Peak Hour Analysis From 07:00 AM to 08:45 AM - Peak 1 of 1										
Peak Hour for Entire Intersection Begins at 07:00 AM										
07:00 AM	422	0	422	10	0	10	3	151	154	586
07:15 AM	461	0	461	13	0	13	5	138	143	617
07:30 AM	479	0	479	10	0	10	3	167	170	659
07:45 AM	397	0	397	8	0	8	6	149	155	560
Total Volume	1759	0	1759	41	0	41	17	605	622	2422
% App. Total	100	0		100	0		2.7	97.3		
PHF	.918	.000	.918	.788	.000	.788	.708	.906	.915	.919

Peggy Malone & Associates

(888) 247-8602

File Name : 3_US 29 & Lake Saponi Dr PM
 Site Code :
 Start Date : 4/14/2021
 Page No : 1

Groups Printed- Cars

Start Time	US 29 Southbound				Lake Saponi Dr Westbound				US 29 Northbound				Int. Total
	Thru	Left	Peds	App. Total	Right	Left	Peds	App. Total	Right	Thru	Peds	App. Total	
04:00 PM	197	0	0	197	8	0	0	8	12	362	0	374	579
04:15 PM	206	0	0	206	5	0	0	5	9	413	0	422	633
04:30 PM	257	0	0	257	12	0	0	12	13	416	0	429	698
04:45 PM	212	0	0	212	7	0	0	7	9	432	0	441	660
Total	872	0	0	872	32	0	0	32	43	1623	0	1666	2570
05:00 PM	197	0	0	197	7	0	0	7	14	421	0	435	639
05:15 PM	209	0	0	209	8	0	0	8	12	438	0	450	667
05:30 PM	218	0	0	218	5	0	0	5	9	440	0	449	672
05:45 PM	217	0	0	217	10	0	0	10	7	394	0	401	628
Total	841	0	0	841	30	0	0	30	42	1693	0	1735	2606
Grand Total	1713	0	0	1713	62	0	0	62	85	3316	0	3401	5176
Apprch %	100	0	0		100	0	0		2.5	97.5	0		
Total %	33.1	0	0	33.1	1.2	0	0	1.2	1.6	64.1	0	65.7	

Start Time	US 29 Southbound			Lake Saponi Dr Westbound			US 29 Northbound			Int. Total
	Thru	Left	App. Total	Right	Left	App. Total	Right	Thru	App. Total	
Peak Hour Analysis From 04:00 PM to 05:45 PM - Peak 1 of 1										
Peak Hour for Entire Intersection Begins at 04:30 PM										
04:30 PM	257	0	257	12	0	12	13	416	429	698
04:45 PM	212	0	212	7	0	7	9	432	441	660
05:00 PM	197	0	197	7	0	7	14	421	435	639
05:15 PM	209	0	209	8	0	8	12	438	450	667
Total Volume	875	0	875	34	0	34	48	1707	1755	2664
% App. Total	100	0		100	0		2.7	97.3		
PHF	.851	.000	.851	.708	.000	.708	.857	.974	.975	.954

Peggy Malone & Associates

(888) 247-8602

File Name : 3_US 29 & Lake Saponi Dr PM
 Site Code :
 Start Date : 4/14/2021
 Page No : 1

Groups Printed- Trucks

Start Time	US 29 Southbound				Lake Saponi Dr Westbound				US 29 Northbound				Int. Total
	Thru	Left	Peds	App. Total	Right	Left	Peds	App. Total	Right	Thru	Peds	App. Total	
04:00 PM	12	0	0	12	0	0	0	0	0	13	0	13	25
04:15 PM	14	0	0	14	0	0	0	0	1	11	0	12	26
04:30 PM	11	0	0	11	1	0	0	1	0	10	0	10	22
04:45 PM	10	0	0	10	0	0	0	0	0	9	0	9	19
Total	47	0	0	47	1	0	0	1	1	43	0	44	92
05:00 PM	3	0	0	3	1	0	0	1	0	7	0	7	11
05:15 PM	6	0	0	6	0	0	0	0	0	8	0	8	14
05:30 PM	5	0	0	5	0	0	0	0	0	11	0	11	16
05:45 PM	4	0	0	4	0	0	0	0	0	7	0	7	11
Total	18	0	0	18	1	0	0	1	0	33	0	33	52
Grand Total	65	0	0	65	2	0	0	2	1	76	0	77	144
Apprch %	100	0	0		100	0	0		1.3	98.7	0		
Total %	45.1	0	0	45.1	1.4	0	0	1.4	0.7	52.8	0	53.5	

Start Time	US 29 Southbound			Lake Saponi Dr Westbound			US 29 Northbound			Int. Total
	Thru	Left	App. Total	Right	Left	App. Total	Right	Thru	App. Total	
Peak Hour Analysis From 04:00 PM to 05:45 PM - Peak 1 of 1										
Peak Hour for Entire Intersection Begins at 04:00 PM										
04:00 PM	12	0	12	0	0	0	0	13	13	25
04:15 PM	14	0	14	0	0	0	1	11	12	26
04:30 PM	11	0	11	1	0	1	0	10	10	22
04:45 PM	10	0	10	0	0	0	0	9	9	19
Total Volume	47	0	47	1	0	1	1	43	44	92
% App. Total	100	0		100	0		2.3	97.7		
PHF	.839	.000	.839	.250	.000	.250	.250	.827	.846	.885

Peggy Malone & Associates

(888) 247-8602

File Name : 3_US 29 & Lake Saponi Dr PM
 Site Code :
 Start Date : 4/14/2021
 Page No : 1

Groups Printed- Combined

Start Time	US 29 Southbound				Lake Saponi Dr Westbound				US 29 Northbound				Int. Total
	Thru	Left	Peds	App. Total	Right	Left	Peds	App. Total	Right	Thru	Peds	App. Total	
04:00 PM	209	0	0	209	8	0	0	8	12	375	0	387	604
04:15 PM	220	0	0	220	5	0	0	5	10	424	0	434	659
04:30 PM	268	0	0	268	13	0	0	13	13	426	0	439	720
04:45 PM	222	0	0	222	7	0	0	7	9	441	0	450	679
Total	919	0	0	919	33	0	0	33	44	1666	0	1710	2662
05:00 PM	200	0	0	200	8	0	0	8	14	428	0	442	650
05:15 PM	215	0	0	215	8	0	0	8	12	446	0	458	681
05:30 PM	223	0	0	223	5	0	0	5	9	451	0	460	688
05:45 PM	221	0	0	221	10	0	0	10	7	401	0	408	639
Total	859	0	0	859	31	0	0	31	42	1726	0	1768	2658
Grand Total	1778	0	0	1778	64	0	0	64	86	3392	0	3478	5320
Apprch %	100	0	0		100	0	0		2.5	97.5	0		
Total %	33.4	0	0	33.4	1.2	0	0	1.2	1.6	63.8	0	65.4	

Start Time	US 29 Southbound			Lake Saponi Dr Westbound			US 29 Northbound			Int. Total
	Thru	Left	App. Total	Right	Left	App. Total	Right	Thru	App. Total	
Peak Hour Analysis From 04:00 PM to 05:45 PM - Peak 1 of 1										
Peak Hour for Entire Intersection Begins at 04:30 PM										
04:30 PM	268	0	268	13	0	13	13	426	439	720
04:45 PM	222	0	222	7	0	7	9	441	450	679
05:00 PM	200	0	200	8	0	8	14	428	442	650
05:15 PM	215	0	215	8	0	8	12	446	458	681
Total Volume	905	0	905	36	0	36	48	1741	1789	2730
% App. Total	100	0		100	0		2.7	97.3		
PHF	.844	.000	.844	.692	.000	.692	.857	.976	.977	.948

Peggy Malone & Associates

(888) 247-8602

File Name : 4_US 29 & Greene Edge Ln AM
 Site Code :
 Start Date : 4/14/2021
 Page No : 1

Groups Printed- Cars

Start Time	US 29 Southbound					US 29 Northbound				Greene Edge Ln Eastbound				Int. Total
	Right	Thru	Left	Peds	App. Total	Thru	Left	Peds	App. Total	Right	Left	Peds	App. Total	
07:00 AM	0	407	0	0	407	136	0	0	136	1	0	0	1	544
07:15 AM	0	442	1	0	443	121	0	0	121	0	0	0	0	564
07:30 AM	0	463	1	0	464	154	0	0	154	0	0	0	0	618
07:45 AM	0	364	3	0	367	146	1	0	147	0	0	0	0	514
Total	0	1676	5	0	1681	557	1	0	558	1	0	0	1	2240
08:00 AM	0	369	4	0	373	137	1	0	138	0	0	0	0	511
08:15 AM	0	347	4	0	351	140	0	0	140	0	0	0	0	491
08:30 AM	0	346	3	0	349	143	0	0	143	0	0	0	0	492
08:45 AM	0	285	2	0	287	166	0	0	166	0	1	0	1	454
Total	0	1347	13	0	1360	586	1	0	587	0	1	0	1	1948
Grand Total	0	3023	18	0	3041	1143	2	0	1145	1	1	0	2	4188
Apprch %	0	99.4	0.6	0		99.8	0.2	0		50	50	0		
Total %	0	72.2	0.4	0	72.6	27.3	0	0	27.3	0	0	0	0	

Start Time	US 29 Southbound				US 29 Northbound			Greene Edge Ln Eastbound			Int. Total
	Right	Thru	Left	App. Total	Thru	Left	App. Total	Right	Left	App. Total	
Peak Hour Analysis From 07:00 AM to 08:45 AM - Peak 1 of 1											
Peak Hour for Entire Intersection Begins at 07:00 AM											
07:00 AM	0	407	0	407	136	0	136	1	0	1	544
07:15 AM	0	442	1	443	121	0	121	0	0	0	564
07:30 AM	0	463	1	464	154	0	154	0	0	0	618
07:45 AM	0	364	3	367	146	1	147	0	0	0	514
Total Volume	0	1676	5	1681	557	1	558	1	0	1	2240
% App. Total	0	99.7	0.3		99.8	0.2		100	0		
PHF	.000	.905	.417	.906	.904	.250	.906	.250	.000	.250	.906

Peggy Malone & Associates

(888) 247-8602

File Name : 4_US 29 & Greene Edge Ln AM
 Site Code :
 Start Date : 4/14/2021
 Page No : 1

Groups Printed- Trucks

Start Time	US 29 Southbound					US 29 Northbound				Greene Edge Ln Eastbound				Int. Total
	Right	Thru	Left	Peds	App. Total	Thru	Left	Peds	App. Total	Right	Left	Peds	App. Total	
07:00 AM	0	15	1	0	16	16	0	0	16	0	0	0	0	32
07:15 AM	0	14	1	0	15	24	0	0	24	0	0	0	0	39
07:30 AM	0	17	0	0	17	13	0	0	13	0	0	0	0	30
07:45 AM	0	26	1	0	27	14	0	0	14	0	0	0	0	41
Total	0	72	3	0	75	67	0	0	67	0	0	0	0	142
08:00 AM	0	15	0	0	15	21	0	0	21	0	0	0	0	36
08:15 AM	0	21	0	0	21	20	0	0	20	0	0	0	0	41
08:30 AM	0	19	0	0	19	14	0	0	14	0	0	0	0	33
08:45 AM	0	21	1	0	22	16	0	0	16	0	0	0	0	38
Total	0	76	1	0	77	71	0	0	71	0	0	0	0	148
Grand Total	0	148	4	0	152	138	0	0	138	0	0	0	0	290
Apprch %	0	97.4	2.6	0		100	0	0		0	0	0		
Total %	0	51	1.4	0	52.4	47.6	0	0	47.6	0	0	0	0	

Start Time	US 29 Southbound				US 29 Northbound				Greene Edge Ln Eastbound				Int. Total	
	Right	Thru	Left	App. Total	Thru	Left	App. Total	Right	Left	App. Total				
Peak Hour Analysis From 07:00 AM to 08:45 AM - Peak 1 of 1														
Peak Hour for Entire Intersection Begins at 07:45 AM														
07:45 AM	0	26	1	27	14	0	14	0	0	0	41			
08:00 AM	0	15	0	15	21	0	21	0	0	0	36			
08:15 AM	0	21	0	21	20	0	20	0	0	0	41			
08:30 AM	0	19	0	19	14	0	14	0	0	0	33			
Total Volume	0	81	1	82	69	0	69	0	0	0	151			
% App. Total	0	98.8	1.2		100	0		0	0					
PHF	.000	.779	.250	.759	.821	.000	.821	.000	.000	.000	.921			

Peggy Malone & Associates

(888) 247-8602

File Name : 4_US 29 & Greene Edge Ln AM
 Site Code :
 Start Date : 4/14/2021
 Page No : 1

Groups Printed- Combined

Start Time	US 29 Southbound					US 29 Northbound				Greene Edge Ln Eastbound				Int. Total
	Right	Thru	Left	Peds	App. Total	Thru	Left	Peds	App. Total	Right	Left	Peds	App. Total	
07:00 AM	0	422	1	0	423	152	0	0	152	1	0	0	1	576
07:15 AM	0	456	2	0	458	145	0	0	145	0	0	0	0	603
07:30 AM	0	480	1	0	481	167	0	0	167	0	0	0	0	648
07:45 AM	0	390	4	0	394	160	1	0	161	0	0	0	0	555
Total	0	1748	8	0	1756	624	1	0	625	1	0	0	1	2382
08:00 AM	0	384	4	0	388	158	1	0	159	0	0	0	0	547
08:15 AM	0	368	4	0	372	160	0	0	160	0	0	0	0	532
08:30 AM	0	365	3	0	368	157	0	0	157	0	0	0	0	525
08:45 AM	0	306	3	0	309	182	0	0	182	0	1	0	1	492
Total	0	1423	14	0	1437	657	1	0	658	0	1	0	1	2096
Grand Total	0	3171	22	0	3193	1281	2	0	1283	1	1	0	2	4478
Apprch %	0	99.3	0.7	0		99.8	0.2	0		50	50	0		
Total %	0	70.8	0.5	0	71.3	28.6	0	0	28.7	0	0	0	0	

Start Time	US 29 Southbound				US 29 Northbound			Greene Edge Ln Eastbound			Int. Total
	Right	Thru	Left	App. Total	Thru	Left	App. Total	Right	Left	App. Total	
Peak Hour Analysis From 07:00 AM to 08:45 AM - Peak 1 of 1											
Peak Hour for Entire Intersection Begins at 07:00 AM											
07:00 AM	0	422	1	423	152	0	152	1	0	1	576
07:15 AM	0	456	2	458	145	0	145	0	0	0	603
07:30 AM	0	480	1	481	167	0	167	0	0	0	648
07:45 AM	0	390	4	394	160	1	161	0	0	0	555
Total Volume	0	1748	8	1756	624	1	625	1	0	1	2382
% App. Total	0	99.5	0.5		99.8	0.2		100	0		
PHF	.000	.910	.500	.913	.934	.250	.936	.250	.000	.250	.919

Peggy Malone & Associates

(888) 247-8602

File Name : 4_US 29 & Greene Edge Ln PM
 Site Code :
 Start Date : 4/14/2021
 Page No : 1

Groups Printed- Cars

Start Time	US 29 Southbound					US 29 Northbound				Greene Edge Ln Eastbound				Int. Total
	Right	Thru	Left	Peds	App. Total	Thru	Left	Peds	App. Total	Right	Left	Peds	App. Total	
04:00 PM	0	185	4	0	189	356	1	0	357	0	1	0	1	547
04:15 PM	0	212	4	0	216	436	0	0	436	0	0	0	0	652
04:30 PM	0	250	6	0	256	409	0	0	409	0	0	0	0	665
04:45 PM	0	206	3	0	209	453	0	0	453	0	0	0	0	662
Total	0	853	17	0	870	1654	1	0	1655	0	1	0	1	2526
05:00 PM	0	197	4	0	201	421	1	0	422	0	0	0	0	623
05:15 PM	1	201	3	0	205	474	0	0	474	0	0	0	0	679
05:30 PM	0	209	4	0	213	426	0	0	426	0	1	0	1	640
05:45 PM	0	213	3	0	216	405	1	0	406	0	0	0	0	622
Total	1	820	14	0	835	1726	2	0	1728	0	1	0	1	2564
Grand Total	1	1673	31	0	1705	3380	3	0	3383	0	2	0	2	5090
Apprch %	0.1	98.1	1.8	0		99.9	0.1	0		0	100	0		
Total %	0	32.9	0.6	0	33.5	66.4	0.1	0	66.5	0	0	0	0	

Start Time	US 29 Southbound				US 29 Northbound			Greene Edge Ln Eastbound			Int. Total
	Right	Thru	Left	App. Total	Thru	Left	App. Total	Right	Left	App. Total	
Peak Hour Analysis From 04:00 PM to 05:45 PM - Peak 1 of 1											
Peak Hour for Entire Intersection Begins at 04:30 PM											
04:30 PM	0	250	6	256	409	0	409	0	0	0	665
04:45 PM	0	206	3	209	453	0	453	0	0	0	662
05:00 PM	0	197	4	201	421	1	422	0	0	0	623
05:15 PM	1	201	3	205	474	0	474	0	0	0	679
Total Volume	1	854	16	871	1757	1	1758	0	0	0	2629
% App. Total	0.1	98	1.8		99.9	0.1		0	0		
PHF	.250	.854	.667	.851	.927	.250	.927	.000	.000	.000	.968

Peggy Malone & Associates

(888) 247-8602

File Name : 4_US 29 & Greene Edge Ln PM
 Site Code :
 Start Date : 4/14/2021
 Page No : 1

Groups Printed- Trucks

Start Time	US 29 Southbound					US 29 Northbound				Greene Edge Ln Eastbound				Int. Total
	Right	Thru	Left	Peds	App. Total	Thru	Left	Peds	App. Total	Right	Left	Peds	App. Total	
04:00 PM	0	12	0	0	12	13	0	0	13	0	0	0	0	25
04:15 PM	0	13	1	0	14	12	0	0	12	0	0	0	0	26
04:30 PM	0	7	0	0	7	10	0	0	10	0	0	0	0	17
04:45 PM	0	13	0	0	13	9	0	0	9	0	0	0	0	22
Total	0	45	1	0	46	44	0	0	44	0	0	0	0	90
05:00 PM	0	3	0	0	3	7	0	0	7	0	0	0	0	10
05:15 PM	0	6	0	0	6	7	0	0	7	0	0	0	0	13
05:30 PM	0	5	0	0	5	11	0	0	11	0	0	0	0	16
05:45 PM	0	4	0	0	4	6	0	0	6	0	0	0	0	10
Total	0	18	0	0	18	31	0	0	31	0	0	0	0	49
Grand Total	0	63	1	0	64	75	0	0	75	0	0	0	0	139
Apprch %	0	98.4	1.6	0		100	0	0		0	0	0		
Total %	0	45.3	0.7	0	46	54	0	0	54	0	0	0	0	

Start Time	US 29 Southbound				US 29 Northbound			Greene Edge Ln Eastbound			Int. Total
	Right	Thru	Left	App. Total	Thru	Left	App. Total	Right	Left	App. Total	
Peak Hour Analysis From 04:00 PM to 05:45 PM - Peak 1 of 1											
Peak Hour for Entire Intersection Begins at 04:00 PM											
04:00 PM	0	12	0	12	13	0	13	0	0	0	25
04:15 PM	0	13	1	14	12	0	12	0	0	0	26
04:30 PM	0	7	0	7	10	0	10	0	0	0	17
04:45 PM	0	13	0	13	9	0	9	0	0	0	22
Total Volume	0	45	1	46	44	0	44	0	0	0	90
% App. Total	0	97.8	2.2		100	0		0	0		
PHF	.000	.865	.250	.821	.846	.000	.846	.000	.000	.000	.865

Peggy Malone & Associates

(800) 247-8602

File Name : 3-Seminole Trail and Frays Mill Rd AM
 Site Code :
 Start Date : 3/27/2018
 Page No : 1

Groups Printed- Car

Start Time	Route 29 Southbound					Frays Mill Rd Westbound					Route 29 Northbound					Frays Mill Rd Eastbound					Int. Total
	Right	Thru	Left	Peds	App. Total	Right	Thru	Left	Peds	App. Total	Right	Thru	Left	Peds	App. Total	Right	Thru	Left	Peds	App. Total	
06:00 AM	0	235	1	0	236	1	0	3	0	4	0	47	1	0	48	15	0	0	0	15	303
06:15 AM	1	279	3	0	283	4	0	17	0	21	1	73	1	0	75	13	0	2	0	15	394
06:30 AM	2	381	1	0	384	4	0	12	0	16	1	67	2	0	70	13	0	1	0	14	484
06:45 AM	3	436	4	0	443	3	0	17	0	20	1	83	0	0	84	28	1	3	0	32	579
Total	6	1331	9	0	1346	12	0	49	0	61	3	270	4	0	277	69	1	6	0	76	1760
07:00 AM	1	478	6	0	485	5	1	24	0	30	2	130	1	0	133	34	0	0	0	34	682
07:15 AM	3	494	8	0	505	11	1	27	0	39	8	135	4	0	147	46	2	2	0	50	741
07:30 AM	6	549	11	0	566	8	4	41	0	53	6	112	1	0	119	52	2	5	0	59	797
07:45 AM	4	392	8	0	404	11	1	39	0	51	5	137	2	0	144	63	4	2	0	69	668
Total	14	1913	33	0	1960	35	7	131	0	173	21	514	8	0	543	195	8	9	0	212	2888
Grand Total	20	3244	42	0	3306	47	7	180	0	234	24	784	12	0	820	264	9	15	0	288	4648
Apprch %	0.6	98.1	1.3	0		20.1	3	76.9	0		2.9	95.6	1.5	0		91.7	3.1	5.2	0		
Total %	0.4	69.8	0.9	0	71.1	1	0.2	3.9	0	5	0.5	16.9	0.3	0	17.6	5.7	0.2	0.3	0	6.2	

Start Time	Route 29 Southbound				Frays Mill Rd Westbound				Route 29 Northbound				Frays Mill Rd Eastbound				Int. Total
	Right	Thru	Left	App. Total	Right	Thru	Left	App. Total	Right	Thru	Left	App. Total	Right	Thru	Left	App. Total	
Peak Hour Analysis From 06:00 AM to 07:45 AM - Peak 1 of 1																	
Peak Hour for Entire Intersection Begins at 07:00 AM																	
07:00 AM	1	478	6	485	5	1	24	30	2	130	1	133	34	0	0	34	682
07:15 AM	3	494	8	505	11	1	27	39	8	135	4	147	46	2	2	50	741
07:30 AM	6	549	11	566	8	4	41	53	6	112	1	119	52	2	5	59	797
07:45 AM	4	392	8	404	11	1	39	51	5	137	2	144	63	4	2	69	668
Total Volume	14	1913	33	1960	35	7	131	173	21	514	8	543	195	8	9	212	2888
% App. Total	0.7	97.6	1.7		20.2	4	75.7		3.9	94.7	1.5		92	3.8	4.2		
PHF	.583	.871	.750	.866	.795	.438	.799	.816	.656	.938	.500	.923	.774	.500	.450	.768	.906

Peggy Malone & Associates

(800) 247-8602

File Name : 3-Seminole Trail and Frays Mill Rd AM
 Site Code :
 Start Date : 3/27/2018
 Page No : 1

Groups Printed- Truck

Start Time	Route 29 Southbound					Frays Mill Rd Westbound					Route 29 Northbound					Frays Mill Rd Eastbound					Int. Total
	Right	Thru	Left	Peds	App. Total	Right	Thru	Left	Peds	App. Total	Right	Thru	Left	Peds	App. Total	Right	Thru	Left	Peds	App. Total	
06:00 AM	0	18	0	0	18	0	0	0	0	0	1	3	0	0	4	0	0	0	0	0	22
06:15 AM	0	12	0	0	12	1	0	0	0	1	0	8	0	0	8	0	0	0	0	0	21
06:30 AM	0	7	0	0	7	1	0	0	0	1	1	7	0	0	8	0	1	0	0	1	17
06:45 AM	0	5	0	0	5	0	0	0	0	0	0	14	0	0	14	0	0	0	0	0	19
Total	0	42	0	0	42	2	0	0	0	2	2	32	0	0	34	0	1	0	0	1	79
07:00 AM	0	14	1	0	15	0	1	0	0	1	0	14	0	0	14	0	0	0	0	0	30
07:15 AM	0	13	0	0	13	0	0	1	0	1	0	14	0	0	14	0	0	0	0	0	28
07:30 AM	0	15	1	0	16	1	0	0	0	1	0	22	1	0	23	0	0	0	0	0	40
07:45 AM	0	9	0	0	9	0	0	0	0	0	4	12	0	0	16	0	0	2	0	2	27
Total	0	51	2	0	53	1	1	1	0	3	4	62	1	0	67	0	0	2	0	2	125
Grand Total	0	93	2	0	95	3	1	1	0	5	6	94	1	0	101	0	1	2	0	3	204
Apprch %	0	97.9	2.1	0		60	20	20	0		5.9	93.1	1	0		0	33.3	66.7	0		
Total %	0	45.6	1	0	46.6	1.5	0.5	0.5	0	2.5	2.9	46.1	0.5	0	49.5	0	0.5	1	0	1.5	

Start Time	Route 29 Southbound				Frays Mill Rd Westbound				Route 29 Northbound				Frays Mill Rd Eastbound				Int. Total
	Right	Thru	Left	App. Total	Right	Thru	Left	App. Total	Right	Thru	Left	App. Total	Right	Thru	Left	App. Total	
Peak Hour Analysis From 06:00 AM to 07:45 AM - Peak 1 of 1																	
Peak Hour for Entire Intersection Begins at 07:00 AM																	
07:00 AM	0	14	1	15	0	1	0	1	0	14	0	14	0	0	0	0	30
07:15 AM	0	13	0	13	0	0	1	1	0	14	0	14	0	0	0	0	28
07:30 AM	0	15	1	16	1	0	0	1	0	22	1	23	0	0	0	0	40
07:45 AM	0	9	0	9	0	0	0	0	4	12	0	16	0	0	2	2	27
Total Volume	0	51	2	53	1	1	1	3	4	62	1	67	0	0	2	2	125
% App. Total	0	96.2	3.8		33.3	33.3	33.3		6	92.5	1.5		0	0	100		
PHF	.000	.850	.500	.828	.250	.250	.250	.750	.250	.705	.250	.728	.000	.000	.250	.250	.781

Peggy Malone & Associates

(800) 247-8602

File Name : 3-Seminole Trail and Frays Mill Rd AM
 Site Code :
 Start Date : 3/27/2018
 Page No : 1

Groups Printed- Combined

Start Time	Route 29 Southbound					Frays Mill Rd Westbound					Route 29 Northbound					Frays Mill Rd Eastbound					Int. Total
	Right	Thru	Left	Peds	App. Total	Right	Thru	Left	Peds	App. Total	Right	Thru	Left	Peds	App. Total	Right	Thru	Left	Peds	App. Total	
06:00 AM	0	253	1	0	254	1	0	3	0	4	1	50	1	0	52	15	0	0	0	15	325
06:15 AM	1	291	3	0	295	5	0	17	0	22	1	81	1	0	83	13	0	2	0	15	415
06:30 AM	2	388	1	0	391	5	0	12	0	17	2	74	2	0	78	13	1	1	0	15	501
06:45 AM	3	441	4	0	448	3	0	17	0	20	1	97	0	0	98	28	1	3	0	32	598
Total	6	1373	9	0	1388	14	0	49	0	63	5	302	4	0	311	69	2	6	0	77	1839
07:00 AM	1	492	7	0	500	5	2	24	0	31	2	144	1	0	147	34	0	0	0	34	712
07:15 AM	3	507	8	0	518	11	1	28	0	40	8	149	4	0	161	46	2	2	0	50	769
07:30 AM	6	564	12	0	582	9	4	41	0	54	6	134	2	0	142	52	2	5	0	59	837
07:45 AM	4	401	8	0	413	11	1	39	0	51	9	149	2	0	160	63	4	4	0	71	695
Total	14	1964	35	0	2013	36	8	132	0	176	25	576	9	0	610	195	8	11	0	214	3013
Grand Total	20	3337	44	0	3401	50	8	181	0	239	30	878	13	0	921	264	10	17	0	291	4852
Apprch %	0.6	98.1	1.3	0		20.9	3.3	75.7	0		3.3	95.3	1.4	0		90.7	3.4	5.8	0		
Total %	0.4	68.8	0.9	0	70.1	1	0.2	3.7	0	4.9	0.6	18.1	0.3	0	19	5.4	0.2	0.4	0	6	

Start Time	Route 29 Southbound				Frays Mill Rd Westbound				Route 29 Northbound				Frays Mill Rd Eastbound				Int. Total
	Right	Thru	Left	App. Total	Right	Thru	Left	App. Total	Right	Thru	Left	App. Total	Right	Thru	Left	App. Total	
Peak Hour Analysis From 06:00 AM to 07:45 AM - Peak 1 of 1																	
Peak Hour for Entire Intersection Begins at 07:00 AM																	
07:00 AM	1	492	7	500	5	2	24	31	2	144	1	147	34	0	0	34	712
07:15 AM	3	507	8	518	11	1	28	40	8	149	4	161	46	2	2	50	769
07:30 AM	6	564	12	582	9	4	41	54	6	134	2	142	52	2	5	59	837
07:45 AM	4	401	8	413	11	1	39	51	9	149	2	160	63	4	4	71	695
Total Volume	14	1964	35	2013	36	8	132	176	25	576	9	610	195	8	11	214	3013
% App. Total	0.7	97.6	1.7		20.5	4.5	75		4.1	94.4	1.5		91.1	3.7	5.1		
PHF	.583	.871	.729	.865	.818	.500	.805	.815	.694	.966	.563	.947	.774	.500	.550	.754	.900

Peggy Malone & Associates

(800) 247-8602

File Name : 3-Seminole Trail and Frays Mill Rd PM
 Site Code :
 Start Date : 3/27/2018
 Page No : 1

Groups Printed- Car

Start Time	Route 29 Southbound					Frays Mill Rd Westbound					Route 29 Northbound					Frays Mill Rd Eastbound					Int. Total
	Right	Thru	Left	Peds	App. Total	Right	Thru	Left	Peds	App. Total	Right	Thru	Left	Peds	App. Total	Right	Thru	Left	Peds	App. Total	
04:00 PM	0	204	4	0	208	10	1	13	0	24	24	403	17	0	444	8	3	2	0	13	689
04:15 PM	1	201	10	0	212	10	1	2	0	13	20	400	30	0	450	12	2	4	0	18	693
04:30 PM	2	223	7	0	232	8	0	5	0	13	24	490	28	0	542	9	0	3	0	12	799
04:45 PM	3	219	10	0	232	13	1	7	0	21	26	485	41	0	552	8	3	6	0	17	822
Total	6	847	31	0	884	41	3	27	0	71	94	1778	116	0	1988	37	8	15	0	60	3003
05:00 PM	1	246	5	0	252	13	2	7	0	22	22	433	22	0	477	10	4	6	0	20	771
05:15 PM	3	212	8	0	223	21	3	9	0	33	27	493	32	0	552	11	1	3	0	15	823
05:30 PM	1	198	10	0	209	19	2	9	0	30	32	515	25	0	572	4	2	1	0	7	818
05:45 PM	3	175	5	0	183	16	1	9	0	26	33	402	23	0	458	5	0	1	0	6	673
Total	8	831	28	0	867	69	8	34	0	111	114	1843	102	0	2059	30	7	11	0	48	3085
Grand Total	14	1678	59	0	1751	110	11	61	0	182	208	3621	218	0	4047	67	15	26	0	108	6088
Apprch %	0.8	95.8	3.4	0		60.4	6	33.5	0		5.1	89.5	5.4	0		62	13.9	24.1	0		
Total %	0.2	27.6	1	0	28.8	1.8	0.2	1	0	3	3.4	59.5	3.6	0	66.5	1.1	0.2	0.4	0	1.8	

Start Time	Route 29 Southbound				Frays Mill Rd Westbound				Route 29 Northbound				Frays Mill Rd Eastbound				Int. Total
	Right	Thru	Left	App. Total	Right	Thru	Left	App. Total	Right	Thru	Left	App. Total	Right	Thru	Left	App. Total	
Peak Hour Analysis From 04:00 PM to 05:45 PM - Peak 1 of 1																	
Peak Hour for Entire Intersection Begins at 04:45 PM																	
04:45 PM	3	219	10	232	13	1	7	21	26	485	41	552	8	3	6	17	822
05:00 PM	1	246	5	252	13	2	7	22	22	433	22	477	10	4	6	20	771
05:15 PM	3	212	8	223	21	3	9	33	27	493	32	552	11	1	3	15	823
05:30 PM	1	198	10	209	19	2	9	30	32	515	25	572	4	2	1	7	818
Total Volume	8	875	33	916	66	8	32	106	107	1926	120	2153	33	10	16	59	3234
% App. Total	0.9	95.5	3.6		62.3	7.5	30.2		5	89.5	5.6		55.9	16.9	27.1		
PHF	.667	.889	.825	.909	.786	.667	.889	.803	.836	.935	.732	.941	.750	.625	.667	.738	.982

Peggy Malone & Associates

(800) 247-8602

File Name : 3-Seminole Trail and Frays Mill Rd PM
 Site Code :
 Start Date : 3/27/2018
 Page No : 1

Groups Printed- Truck

Start Time	Route 29 Southbound					Frays Mill Rd Westbound					Route 29 Northbound					Frays Mill Rd Eastbound					Int. Total
	Right	Thru	Left	Peds	App. Total	Right	Thru	Left	Peds	App. Total	Right	Thru	Left	Peds	App. Total	Right	Thru	Left	Peds	App. Total	
04:00 PM	0	14	0	0	14	0	0	0	0	0	1	8	0	0	9	0	0	1	0	1	24
04:15 PM	0	12	0	0	12	1	0	0	0	1	4	14	0	0	18	0	0	0	0	0	31
04:30 PM	0	6	0	0	6	0	0	1	0	1	2	12	2	0	16	0	0	0	0	0	23
04:45 PM	0	11	0	0	11	1	1	1	0	3	0	6	0	0	6	0	0	0	0	0	20
Total	0	43	0	0	43	2	1	2	0	5	7	40	2	0	49	0	0	1	0	1	98
05:00 PM	0	5	0	0	5	0	0	1	0	1	0	12	1	0	13	1	1	0	0	2	21
05:15 PM	0	7	0	0	7	0	0	0	0	0	0	9	0	0	9	0	0	0	0	0	16
05:30 PM	0	9	0	0	9	0	0	0	0	0	0	7	0	0	7	0	0	0	0	0	16
05:45 PM	0	6	0	0	6	0	0	0	0	0	0	6	0	0	6	0	0	0	0	0	12
Total	0	27	0	0	27	0	0	1	0	1	0	34	1	0	35	1	1	0	0	2	65
Grand Total	0	70	0	0	70	2	1	3	0	6	7	74	3	0	84	1	1	1	0	3	163
Apprch %	0	100	0	0		33.3	16.7	50	0		8.3	88.1	3.6	0		33.3	33.3	33.3	0		
Total %	0	42.9	0	0	42.9	1.2	0.6	1.8	0	3.7	4.3	45.4	1.8	0	51.5	0.6	0.6	0.6	0	1.8	

Start Time	Route 29 Southbound				Frays Mill Rd Westbound				Route 29 Northbound				Frays Mill Rd Eastbound				Int. Total
	Right	Thru	Left	App. Total	Right	Thru	Left	App. Total	Right	Thru	Left	App. Total	Right	Thru	Left	App. Total	
Peak Hour Analysis From 04:00 PM to 05:45 PM - Peak 1 of 1																	
Peak Hour for Entire Intersection Begins at 04:00 PM																	
04:00 PM	0	14	0	14	0	0	0	0	1	8	0	9	0	0	1	1	24
04:15 PM	0	12	0	12	1	0	0	1	4	14	0	18	0	0	0	0	31
04:30 PM	0	6	0	6	0	0	1	1	2	12	2	16	0	0	0	0	23
04:45 PM	0	11	0	11	1	1	1	3	0	6	0	6	0	0	0	0	20
Total Volume	0	43	0	43	2	1	2	5	7	40	2	49	0	0	1	1	98
% App. Total	0	100	0		40	20	40		14.3	81.6	4.1		0	0	100		
PHF	.000	.768	.000	.768	.500	.250	.500	.417	.438	.714	.250	.681	.000	.000	.250	.250	.790

Peggy Malone & Associates

(800) 247-8602

File Name : 3-Seminole Trail and Frays Mill Rd PM
 Site Code :
 Start Date : 3/27/2018
 Page No : 1

Groups Printed- Combined

Start Time	Route 29 Southbound					Frays Mill Rd Westbound					Route 29 Northbound					Frays Mill Rd Eastbound					Int. Total
	Right	Thru	Left	Peds	App. Total	Right	Thru	Left	Peds	App. Total	Right	Thru	Left	Peds	App. Total	Right	Thru	Left	Peds	App. Total	
04:00 PM	0	218	4	0	222	10	1	13	0	24	25	411	17	0	453	8	3	3	0	14	713
04:15 PM	1	213	10	0	224	11	1	2	0	14	24	414	30	0	468	12	2	4	0	18	724
04:30 PM	2	229	7	0	238	8	0	6	0	14	26	502	30	0	558	9	0	3	0	12	822
04:45 PM	3	230	10	0	243	14	2	8	0	24	26	491	41	0	558	8	3	6	0	17	842
Total	6	890	31	0	927	43	4	29	0	76	101	1818	118	0	2037	37	8	16	0	61	3101
05:00 PM	1	251	5	0	257	13	2	8	0	23	22	445	23	0	490	11	5	6	0	22	792
05:15 PM	3	219	8	0	230	21	3	9	0	33	27	502	32	0	561	11	1	3	0	15	839
05:30 PM	1	207	10	0	218	19	2	9	0	30	32	522	25	0	579	4	2	1	0	7	834
05:45 PM	3	181	5	0	189	16	1	9	0	26	33	408	23	0	464	5	0	1	0	6	685
Total	8	858	28	0	894	69	8	35	0	112	114	1877	103	0	2094	31	8	11	0	50	3150
Grand Total	14	1748	59	0	1821	112	12	64	0	188	215	3695	221	0	4131	68	16	27	0	111	6251
Apprch %	0.8	96	3.2	0		59.6	6.4	34	0		5.2	89.4	5.3	0		61.3	14.4	24.3	0		
Total %	0.2	28	0.9	0	29.1	1.8	0.2	1	0	3	3.4	59.1	3.5	0	66.1	1.1	0.3	0.4	0	1.8	

Start Time	Route 29 Southbound				Frays Mill Rd Westbound				Route 29 Northbound				Frays Mill Rd Eastbound				Int. Total
	Right	Thru	Left	App. Total	Right	Thru	Left	App. Total	Right	Thru	Left	App. Total	Right	Thru	Left	App. Total	
Peak Hour Analysis From 04:00 PM to 05:45 PM - Peak 1 of 1																	
Peak Hour for Entire Intersection Begins at 04:45 PM																	
04:45 PM	3	230	10	243	14	2	8	24	26	491	41	558	8	3	6	17	842
05:00 PM	1	251	5	257	13	2	8	23	22	445	23	490	11	5	6	22	792
05:15 PM	3	219	8	230	21	3	9	33	27	502	32	561	11	1	3	15	839
05:30 PM	1	207	10	218	19	2	9	30	32	522	25	579	4	2	1	7	834
Total Volume	8	907	33	948	67	9	34	110	107	1960	121	2188	34	11	16	61	3307
% App. Total	0.8	95.7	3.5		60.9	8.2	30.9		4.9	89.6	5.5		55.7	18	26.2		
PHF	.667	.903	.825	.922	.798	.750	.944	.833	.836	.939	.738	.945	.773	.550	.667	.693	.982

Peggy Malone & Associates

(888) 247-8602

File Name : 5_US 29 & Dickerson Ln AM
 Site Code :
 Start Date : 4/14/2021
 Page No : 1

Groups Printed- Cars

Start Time	US 29 Southbound					Private Driveway Westbound					US 29 Northbound					Dickerson Ln Eastbound					Int. Total
	Right	Thru	Left	Peds	App. Total	Right	Thru	Left	Peds	App. Total	Right	Thru	Left	Peds	App. Total	Right	Thru	Left	Peds	App. Total	
07:00 AM	1	461	0	0	462	0	0	0	0	0	0	122	1	0	123	2	0	5	0	7	592
07:15 AM	4	476	0	0	480	0	0	1	0	1	0	143	1	0	144	4	0	2	0	6	631
07:30 AM	6	502	0	0	508	0	0	0	0	0	0	130	2	0	132	5	0	0	0	5	645
07:45 AM	5	419	2	0	426	0	0	0	0	0	0	139	4	0	143	3	0	3	0	6	575
Total	16	1858	2	0	1876	0	0	1	0	1	0	534	8	0	542	14	0	10	0	24	2443
08:00 AM	7	404	1	0	412	0	0	0	0	0	0	143	4	0	147	5	0	3	0	8	567
08:15 AM	5	406	0	0	411	0	0	0	0	0	0	141	5	0	146	7	0	3	0	10	567
08:30 AM	5	382	0	0	387	0	0	0	0	0	0	142	4	0	146	2	0	1	0	3	536
08:45 AM	10	300	1	0	311	0	0	0	0	0	0	158	11	0	169	3	0	7	0	10	490
Total	27	1492	2	0	1521	0	0	0	0	0	0	584	24	0	608	17	0	14	0	31	2160
Grand Total	43	3350	4	0	3397	0	0	1	0	1	0	1118	32	0	1150	31	0	24	0	55	4603
Apprch %	1.3	98.6	0.1	0		0	0	100	0		0	97.2	2.8	0		56.4	0	43.6	0		
Total %	0.9	72.8	0.1	0	73.8	0	0	0	0	0	0	24.3	0.7	0	25	0.7	0	0.5	0	1.2	

Start Time	US 29 Southbound				Private Driveway Westbound				US 29 Northbound				Dickerson Ln Eastbound				Int. Total
	Right	Thru	Left	App. Total	Right	Thru	Left	App. Total	Right	Thru	Left	App. Total	Right	Thru	Left	App. Total	
Peak Hour Analysis From 07:00 AM to 08:45 AM - Peak 1 of 1																	
Peak Hour for Entire Intersection Begins at 07:00 AM																	
07:00 AM	1	461	0	462	0	0	0	0	0	122	1	123	2	0	5	7	592
07:15 AM	4	476	0	480	0	0	1	1	0	143	1	144	4	0	2	6	631
07:30 AM	6	502	0	508	0	0	0	0	0	130	2	132	5	0	0	5	645
07:45 AM	5	419	2	426	0	0	0	0	0	139	4	143	3	0	3	6	575
Total Volume	16	1858	2	1876	0	0	1	1	0	534	8	542	14	0	10	24	2443
% App. Total	0.9	99	0.1		0	0	100		0	98.5	1.5		58.3	0	41.7		
PHF	.667	.925	.250	.923	.000	.000	.250	.250	.000	.934	.500	.941	.700	.000	.500	.857	.947

Peggy Malone & Associates

(888) 247-8602

File Name : 5_US 29 & Dickerson Ln AM
 Site Code :
 Start Date : 4/14/2021
 Page No : 1

Groups Printed- Combined

Start Time	US 29 Southbound					Private Driveway Westbound					US 29 Northbound					Dickerson Ln Eastbound					Int. Total
	Right	Thru	Left	Peds	App. Total	Right	Thru	Left	Peds	App. Total	Right	Thru	Left	Peds	App. Total	Right	Thru	Left	Peds	App. Total	
07:00 AM	1	473	0	0	474	0	0	0	0	0	0	141	3	0	144	2	0	5	0	7	625
07:15 AM	4	491	0	0	495	0	0	1	0	1	0	163	1	0	164	4	0	2	0	6	666
07:30 AM	6	518	0	0	524	0	0	0	0	0	0	142	2	0	144	6	0	0	0	6	674
07:45 AM	5	443	2	0	450	0	0	0	0	0	0	155	5	0	160	3	0	3	0	6	616
Total	16	1925	2	0	1943	0	0	1	0	1	0	601	11	0	612	15	0	10	0	25	2581
08:00 AM	7	423	1	0	431	0	0	0	0	0	0	156	4	0	160	5	0	3	0	8	599
08:15 AM	5	422	0	0	427	0	0	0	0	0	0	156	5	0	161	7	0	3	0	10	598
08:30 AM	6	399	0	0	405	0	0	0	0	0	0	157	6	0	163	2	0	1	0	3	571
08:45 AM	12	316	1	0	329	0	0	0	0	0	0	175	11	0	186	4	0	7	0	11	526
Total	30	1560	2	0	1592	0	0	0	0	0	0	644	26	0	670	18	0	14	0	32	2294
Grand Total	46	3485	4	0	3535	0	0	1	0	1	0	1245	37	0	1282	33	0	24	0	57	4875
Apprch %	1.3	98.6	0.1	0		0	0	100	0		0	97.1	2.9	0		57.9	0	42.1	0		
Total %	0.9	71.5	0.1	0	72.5	0	0	0	0	0	0	25.5	0.8	0	26.3	0.7	0	0.5	0	1.2	

Start Time	US 29 Southbound				Private Driveway Westbound				US 29 Northbound				Dickerson Ln Eastbound				Int. Total
	Right	Thru	Left	App. Total	Right	Thru	Left	App. Total	Right	Thru	Left	App. Total	Right	Thru	Left	App. Total	
Peak Hour Analysis From 07:00 AM to 08:45 AM - Peak 1 of 1																	
Peak Hour for Entire Intersection Begins at 07:00 AM																	
07:00 AM	1	473	0	474	0	0	0	0	0	141	3	144	2	0	5	7	625
07:15 AM	4	491	0	495	0	0	1	1	0	163	1	164	4	0	2	6	666
07:30 AM	6	518	0	524	0	0	0	0	0	142	2	144	6	0	0	6	674
07:45 AM	5	443	2	450	0	0	0	0	0	155	5	160	3	0	3	6	616
Total Volume	16	1925	2	1943	0	0	1	1	0	601	11	612	15	0	10	25	2581
% App. Total	0.8	99.1	0.1		0	0	100		0	98.2	1.8		60	0	40		
PHF	.667	.929	.250	.927	.000	.000	.250	.250	.000	.922	.550	.933	.625	.000	.500	.893	.957

Peggy Malone & Associates

(888) 247-8602

File Name : 5_US 29 & Dickerson Ln PM
 Site Code :
 Start Date : 4/14/2021
 Page No : 1

Groups Printed- Cars

Start Time	US 29 Southbound					Private Driveway Westbound					US 29 Northbound					Dickerson Ln Eastbound					Int. Total
	Right	Thru	Left	Peds	App. Total	Right	Thru	Left	Peds	App. Total	Right	Thru	Left	Peds	App. Total	Right	Thru	Left	Peds	App. Total	
04:00 PM	0	207	0	0	207	0	0	0	0	0	0	393	3	0	396	5	0	1	0	6	609
04:15 PM	2	211	0	0	213	0	0	0	0	0	0	442	4	0	446	3	0	3	0	6	665
04:30 PM	1	251	0	0	252	0	0	0	0	0	0	419	4	0	423	4	0	5	0	9	684
04:45 PM	4	236	1	0	241	0	0	0	0	0	0	484	16	0	500	2	0	4	0	6	747
Total	7	905	1	0	913	0	0	0	0	0	0	1738	27	0	1765	14	0	13	0	27	2705
05:00 PM	4	205	0	0	209	0	0	0	0	0	1	488	6	0	495	4	0	7	0	11	715
05:15 PM	4	210	0	0	214	0	0	0	0	0	1	509	6	0	516	1	0	5	0	6	736
05:30 PM	4	212	0	0	216	0	0	0	0	0	0	402	4	0	406	2	0	4	0	6	628
05:45 PM	4	208	0	0	212	0	0	0	0	0	0	442	8	0	450	3	0	2	0	5	667
Total	16	835	0	0	851	0	0	0	0	0	2	1841	24	0	1867	10	0	18	0	28	2746
Grand Total	23	1740	1	0	1764	0	0	0	0	0	2	3579	51	0	3632	24	0	31	0	55	5451
Apprch %	1.3	98.6	0.1	0		0	0	0	0		0.1	98.5	1.4	0		43.6	0	56.4	0		
Total %	0.4	31.9	0	0	32.4	0	0	0	0		0	65.7	0.9	0	66.6	0.4	0	0.6	0		1

Start Time	US 29 Southbound				Private Driveway Westbound				US 29 Northbound				Dickerson Ln Eastbound				Int. Total	
	Right	Thru	Left	App. Total	Right	Thru	Left	App. Total	Right	Thru	Left	App. Total	Right	Thru	Left	App. Total		
Peak Hour Analysis From 04:00 PM to 05:45 PM - Peak 1 of 1																		
Peak Hour for Entire Intersection Begins at 04:30 PM																		
04:30 PM	1	251	0	252	0	0	0	0	0	0	419	4	423	4	0	5	9	684
04:45 PM	4	236	1	241	0	0	0	0	0	0	484	16	500	2	0	4	6	747
05:00 PM	4	205	0	209	0	0	0	0	0	1	488	6	495	4	0	7	11	715
05:15 PM	4	210	0	214	0	0	0	0	0	1	509	6	516	1	0	5	6	736
Total Volume	13	902	1	916	0	0	0	0	0	2	1900	32	1934	11	0	21	32	2882
% App. Total	1.4	98.5	0.1		0	0	0			0.1	98.2	1.7		34.4	0	65.6		
PHF	.813	.898	.250	.909	.000	.000	.000	.000		.500	.933	.500	.937	.688	.000	.750	.727	.965

Peggy Malone & Associates

(888) 247-8602

File Name : 5_US 29 & Dickerson Ln PM
 Site Code :
 Start Date : 4/14/2021
 Page No : 1

Groups Printed- Combined

Start Time	US 29 Southbound					Private Driveway Westbound					US 29 Northbound					Dickerson Ln Eastbound					Int. Total
	Right	Thru	Left	Peds	App. Total	Right	Thru	Left	Peds	App. Total	Right	Thru	Left	Peds	App. Total	Right	Thru	Left	Peds	App. Total	
04:00 PM	0	220	0	0	220	0	0	0	0	0	0	403	3	0	406	5	0	1	0	6	632
04:15 PM	2	223	0	0	225	0	0	0	0	0	0	453	4	0	457	3	0	3	0	6	688
04:30 PM	1	260	0	0	261	0	0	0	0	0	0	434	5	0	439	4	0	5	0	9	709
04:45 PM	5	247	1	0	253	0	0	0	0	0	0	496	17	0	513	2	0	4	0	6	772
Total	8	950	1	0	959	0	0	0	0	0	0	1786	29	0	1815	14	0	13	0	27	2801
05:00 PM	4	211	0	0	215	0	0	0	0	0	1	494	6	0	501	4	0	9	0	13	729
05:15 PM	4	217	0	0	221	0	0	0	0	0	1	516	6	0	523	1	0	5	0	6	750
05:30 PM	4	217	0	0	221	0	0	0	0	0	0	411	4	0	415	2	0	4	0	6	642
05:45 PM	4	214	0	0	218	0	0	0	0	0	0	448	8	0	456	3	0	2	0	5	679
Total	16	859	0	0	875	0	0	0	0	0	2	1869	24	0	1895	10	0	20	0	30	2800
Grand Total	24	1809	1	0	1834	0	0	0	0	0	2	3655	53	0	3710	24	0	33	0	57	5601
Apprch %	1.3	98.6	0.1	0		0	0	0	0		0.1	98.5	1.4	0		42.1	0	57.9	0		
Total %	0.4	32.3	0	0	32.7	0	0	0	0	0	0	65.3	0.9	0	66.2	0.4	0	0.6	0	1	

Start Time	US 29 Southbound				Private Driveway Westbound				US 29 Northbound				Dickerson Ln Eastbound				Int. Total	
	Right	Thru	Left	App. Total	Right	Thru	Left	App. Total	Right	Thru	Left	App. Total	Right	Thru	Left	App. Total		
Peak Hour Analysis From 04:00 PM to 05:45 PM - Peak 1 of 1																		
Peak Hour for Entire Intersection Begins at 04:30 PM																		
04:30 PM	1	260	0	261	0	0	0	0	0	0	434	5	439	4	0	5	9	709
04:45 PM	5	247	1	253	0	0	0	0	0	0	496	17	513	2	0	4	6	772
05:00 PM	4	211	0	215	0	0	0	0	0	1	494	6	501	4	0	9	13	729
05:15 PM	4	217	0	221	0	0	0	0	0	1	516	6	523	1	0	5	6	750
Total Volume	14	935	1	950	0	0	0	0	0	2	1940	34	1976	11	0	23	34	2960
% App. Total	1.5	98.4	0.1		0	0	0		0.1	98.2	1.7			32.4	0	67.6		
PHF	.700	.899	.250	.910	.000	.000	.000	.000	.500	.940	.500	.945	.688	.000	.639	.654	.959	

Peggy Malone & Associates

(888) 247-8602

File Name : 6_US 29 & Austin Dr AM
 Site Code :
 Start Date : 4/14/2021
 Page No : 1

Groups Printed- Cars

Start Time	US 29 Southbound					Driveway Westbound					US 29 Northbound					Austin Dr Eastbound					Int. Total
	Right	Thru	Left	Peds	App. Total	Right	Thru	Left	Peds	App. Total	Right	Thru	Left	Peds	App. Total	Right	Thru	Left	Peds	App. Total	
07:00 AM	0	439	0	0	439	0	0	0	0	0	0	122	2	0	124	6	0	0	0	6	569
07:15 AM	2	486	0	0	488	0	0	0	0	0	0	141	2	0	143	12	0	0	0	12	643
07:30 AM	2	502	0	0	504	0	0	0	0	0	0	131	6	0	137	5	0	0	0	5	646
07:45 AM	5	429	0	0	434	0	0	0	0	0	0	145	5	0	150	4	2	2	0	8	592
Total	9	1856	0	0	1865	0	0	0	0	0	0	539	15	0	554	27	2	2	0	31	2450
08:00 AM	3	390	0	0	393	0	0	0	0	0	0	147	5	0	152	13	0	1	0	14	559
08:15 AM	3	412	0	0	415	0	0	0	0	0	0	153	8	0	161	4	0	0	0	4	580
08:30 AM	5	371	0	0	376	0	0	0	0	0	0	144	5	0	149	7	0	5	0	12	537
08:45 AM	1	314	0	0	315	0	0	0	0	0	0	153	3	0	156	10	0	1	0	11	482
Total	12	1487	0	0	1499	0	0	0	0	0	0	597	21	0	618	34	0	7	0	41	2158
Grand Total	21	3343	0	0	3364	0	0	0	0	0	0	1136	36	0	1172	61	2	9	0	72	4608
Apprch %	0.6	99.4	0	0		0	0	0	0	0	0	96.9	3.1	0		84.7	2.8	12.5	0		
Total %	0.5	72.5	0	0	73	0	0	0	0	0	0	24.7	0.8	0	25.4	1.3	0	0.2	0	1.6	

Start Time	US 29 Southbound				Driveway Westbound				US 29 Northbound				Austin Dr Eastbound				Int. Total
	Right	Thru	Left	App. Total	Right	Thru	Left	App. Total	Right	Thru	Left	App. Total	Right	Thru	Left	App. Total	
Peak Hour Analysis From 07:00 AM to 08:45 AM - Peak 1 of 1																	
Peak Hour for Entire Intersection Begins at 07:00 AM																	
07:00 AM	0	439	0	439	0	0	0	0	0	122	2	124	6	0	0	6	569
07:15 AM	2	486	0	488	0	0	0	0	0	141	2	143	12	0	0	12	643
07:30 AM	2	502	0	504	0	0	0	0	0	131	6	137	5	0	0	5	646
07:45 AM	5	429	0	434	0	0	0	0	0	145	5	150	4	2	2	8	592
Total Volume	9	1856	0	1865	0	0	0	0	0	539	15	554	27	2	2	31	2450
% App. Total	0.5	99.5	0		0	0	0		0	97.3	2.7		87.1	6.5	6.5		
PHF	.450	.924	.000	.925	.000	.000	.000	.000	.000	.929	.625	.923	.563	.250	.250	.646	.948

Peggy Malone & Associates

(888) 247-8602

File Name : 6_US 29 & Austin Dr AM
 Site Code :
 Start Date : 4/14/2021
 Page No : 1

Groups Printed- Trucks

Start Time	US 29 Southbound					Driveway Westbound					US 29 Northbound					Austin Dr Eastbound					Int. Total
	Right	Thru	Left	Peds	App. Total	Right	Thru	Left	Peds	App. Total	Right	Thru	Left	Peds	App. Total	Right	Thru	Left	Peds	App. Total	
07:00 AM	0	12	0	0	12	0	0	0	0	0	0	19	0	0	19	2	0	0	0	2	33
07:15 AM	1	14	0	0	15	0	0	0	0	0	0	21	2	0	23	1	0	0	0	1	39
07:30 AM	0	16	0	0	16	0	0	0	0	0	0	11	0	0	11	0	0	0	0	0	27
07:45 AM	1	22	0	0	23	0	0	0	0	0	0	17	0	0	17	0	0	0	0	0	40
Total	2	64	0	0	66	0	0	0	0	0	0	68	2	0	70	3	0	0	0	3	139
08:00 AM	0	18	0	0	18	0	0	0	0	0	0	17	0	0	17	0	0	1	0	1	36
08:15 AM	1	13	0	0	14	0	0	0	0	0	0	19	1	0	20	0	0	0	0	0	34
08:30 AM	0	16	0	0	16	0	0	0	0	0	0	19	2	0	21	1	0	2	0	3	40
08:45 AM	1	20	0	0	21	0	0	0	0	0	0	15	0	0	15	0	0	1	0	1	37
Total	2	67	0	0	69	0	0	0	0	0	0	70	3	0	73	1	0	4	0	5	147
Grand Total	4	131	0	0	135	0	0	0	0	0	0	138	5	0	143	4	0	4	0	8	286
Apprch %	3	97	0	0		0	0	0	0		0	96.5	3.5	0		50	0	50	0		
Total %	1.4	45.8	0	0	47.2	0	0	0	0	0	0	48.3	1.7	0	50	1.4	0	1.4	0	2.8	

Start Time	US 29 Southbound				Driveway Westbound				US 29 Northbound				Austin Dr Eastbound				Int. Total				
	Right	Thru	Left	App. Total	Right	Thru	Left	App. Total	Right	Thru	Left	App. Total	Right	Thru	Left	App. Total					
Peak Hour Analysis From 07:00 AM to 08:45 AM - Peak 1 of 1																					
Peak Hour for Entire Intersection Begins at 07:45 AM																					
07:45 AM	1	22	0	23	0	0	0	0	0	0	17	0	17	0	0	0	0	0	0	0	40
08:00 AM	0	18	0	18	0	0	0	0	0	0	17	0	17	0	0	1	1	0	0	1	36
08:15 AM	1	13	0	14	0	0	0	0	0	0	19	1	20	0	0	0	0	0	0	0	34
08:30 AM	0	16	0	16	0	0	0	0	0	0	19	2	21	1	0	2	3	0	0	3	40
Total Volume	2	69	0	71	0	0	0	0	0	0	72	3	75	1	0	3	4	0	0	4	150
% App. Total	2.8	97.2	0		0	0	0		0	0	96	4		25	0	75					
PHF	.500	.784	.000	.772	.000	.000	.000	.000	.000	.000	.947	.375	.893	.250	.000	.375	.333				.938

Peggy Malone & Associates

(888) 247-8602

File Name : 6_US 29 & Austin Dr AM
 Site Code :
 Start Date : 4/14/2021
 Page No : 1

Groups Printed- Combined

Start Time	US 29 Southbound					Driveway Westbound					US 29 Northbound					Austin Dr Eastbound					Int. Total
	Right	Thru	Left	Peds	App. Total	Right	Thru	Left	Peds	App. Total	Right	Thru	Left	Peds	App. Total	Right	Thru	Left	Peds	App. Total	
07:00 AM	0	451	0	0	451	0	0	0	0	0	0	141	2	0	143	8	0	0	0	8	602
07:15 AM	3	500	0	0	503	0	0	0	0	0	0	162	4	0	166	13	0	0	0	13	682
07:30 AM	2	518	0	0	520	0	0	0	0	0	0	142	6	0	148	5	0	0	0	5	673
07:45 AM	6	451	0	0	457	0	0	0	0	0	0	162	5	0	167	4	2	2	0	8	632
Total	11	1920	0	0	1931	0	0	0	0	0	0	607	17	0	624	30	2	2	0	34	2589
08:00 AM	3	408	0	0	411	0	0	0	0	0	0	164	5	0	169	13	0	2	0	15	595
08:15 AM	4	425	0	0	429	0	0	0	0	0	0	172	9	0	181	4	0	0	0	4	614
08:30 AM	5	387	0	0	392	0	0	0	0	0	0	163	7	0	170	8	0	7	0	15	577
08:45 AM	2	334	0	0	336	0	0	0	0	0	0	168	3	0	171	10	0	2	0	12	519
Total	14	1554	0	0	1568	0	0	0	0	0	0	667	24	0	691	35	0	11	0	46	2305
Grand Total	25	3474	0	0	3499	0	0	0	0	0	0	1274	41	0	1315	65	2	13	0	80	4894
Apprch %	0.7	99.3	0	0		0	0	0	0		0	96.9	3.1	0		81.2	2.5	16.2	0		
Total %	0.5	71	0	0	71.5	0	0	0	0	0	0	26	0.8	0	26.9	1.3	0	0.3	0	1.6	

Start Time	US 29 Southbound				Driveway Westbound				US 29 Northbound				Austin Dr Eastbound				Int. Total
	Right	Thru	Left	App. Total	Right	Thru	Left	App. Total	Right	Thru	Left	App. Total	Right	Thru	Left	App. Total	
Peak Hour Analysis From 07:00 AM to 08:45 AM - Peak 1 of 1																	
Peak Hour for Entire Intersection Begins at 07:00 AM																	
07:00 AM	0	451	0	451	0	0	0	0	0	141	2	143	8	0	0	8	602
07:15 AM	3	500	0	503	0	0	0	0	0	162	4	166	13	0	0	13	682
07:30 AM	2	518	0	520	0	0	0	0	0	142	6	148	5	0	0	5	673
07:45 AM	6	451	0	457	0	0	0	0	0	162	5	167	4	2	2	8	632
Total Volume	11	1920	0	1931	0	0	0	0	0	607	17	624	30	2	2	34	2589
% App. Total	0.6	99.4	0		0	0	0		0	97.3	2.7		88.2	5.9	5.9		
PHF	.458	.927	.000	.928	.000	.000	.000	.000	.000	.937	.708	.934	.577	.250	.250	.654	.949

Peggy Malone & Associates

(888) 247-8602

File Name : 6_US 29 & Austin Dr PM
 Site Code :
 Start Date : 4/14/2021
 Page No : 1

Groups Printed- Cars

Start Time	US 29 Southbound					Driveway Westbound					US 29 Northbound					Austin Dr Eastbound					Int. Total
	Right	Thru	Left	Peds	App. Total	Right	Thru	Left	Peds	App. Total	Right	Thru	Left	Peds	App. Total	Right	Thru	Left	Peds	App. Total	
04:00 PM	2	200	0	0	202	0	0	0	0	0	0	405	3	0	408	4	0	4	0	8	618
04:15 PM	1	223	0	0	224	0	0	0	0	0	0	438	6	0	444	5	0	3	0	8	676
04:30 PM	5	257	0	0	262	0	0	0	0	0	0	438	7	0	445	10	0	0	0	10	717
04:45 PM	5	239	0	0	244	0	0	0	0	0	0	491	5	0	496	9	0	3	0	12	752
Total	13	919	0	0	932	0	0	0	0	0	0	1772	21	0	1793	28	0	10	0	38	2763
05:00 PM	2	193	0	0	195	0	0	0	0	0	0	493	6	0	499	9	0	3	0	12	706
05:15 PM	7	213	0	0	220	0	0	0	0	0	0	490	6	0	496	5	0	4	0	9	725
05:30 PM	5	194	0	0	199	0	0	0	0	0	0	418	12	0	430	5	0	0	0	5	634
05:45 PM	4	210	0	0	214	0	0	0	0	0	0	420	2	0	422	7	0	0	0	7	643
Total	18	810	0	0	828	0	0	0	0	0	0	1821	26	0	1847	26	0	7	0	33	2708
Grand Total	31	1729	0	0	1760	0	0	0	0	0	0	3593	47	0	3640	54	0	17	0	71	5471
Apprch %	1.8	98.2	0	0		0	0	0	0		0	98.7	1.3	0		76.1	0	23.9	0		
Total %	0.6	31.6	0	0	32.2	0	0	0	0	0	0	65.7	0.9	0	66.5	1	0	0.3	0	1.3	

Start Time	US 29 Southbound				Driveway Westbound				US 29 Northbound				Austin Dr Eastbound				Int. Total	
	Right	Thru	Left	App. Total	Right	Thru	Left	App. Total	Right	Thru	Left	App. Total	Right	Thru	Left	App. Total		
Peak Hour Analysis From 04:00 PM to 05:45 PM - Peak 1 of 1																		
Peak Hour for Entire Intersection Begins at 04:30 PM																		
04:30 PM	5	257	0	262	0	0	0	0	0	0	438	7	445	10	0	0	10	717
04:45 PM	5	239	0	244	0	0	0	0	0	0	491	5	496	9	0	3	12	752
05:00 PM	2	193	0	195	0	0	0	0	0	0	493	6	499	9	0	3	12	706
05:15 PM	7	213	0	220	0	0	0	0	0	0	490	6	496	5	0	4	9	725
Total Volume	19	902	0	921	0	0	0	0	0	0	1912	24	1936	33	0	10	43	2900
% App. Total	2.1	97.9	0		0	0	0		0	0	98.8	1.2		76.7	0	23.3		
PHF	.679	.877	.000	.879	.000	.000	.000	.000	.000	.000	.970	.857	.970	.825	.000	.625	.896	.964

Peggy Malone & Associates

(888) 247-8602

File Name : 6_US 29 & Austin Dr PM
 Site Code :
 Start Date : 4/14/2021
 Page No : 1

Groups Printed- Trucks

Start Time	US 29 Southbound					Driveway Westbound					US 29 Northbound					Austin Dr Eastbound					Int. Total	
	Right	Thru	Left	Peds	App. Total	Right	Thru	Left	Peds	App. Total	Right	Thru	Left	Peds	App. Total	Right	Thru	Left	Peds	App. Total		
04:00 PM	0	13	0	0	13	0	0	0	0	0	0	10	0	0	10	0	0	0	0	0	0	23
04:15 PM	0	12	0	0	12	0	0	0	0	0	0	11	0	0	11	0	0	0	0	0	0	23
04:30 PM	0	8	0	0	8	0	0	0	0	0	0	15	1	0	16	0	0	0	0	0	0	24
04:45 PM	1	11	0	0	12	0	0	0	0	0	0	11	1	0	12	1	0	0	0	0	1	25
Total	1	44	0	0	45	0	0	0	0	0	0	47	2	0	49	1	0	0	0	0	1	95
05:00 PM	1	6	0	0	7	0	0	0	0	0	0	7	0	0	7	0	0	0	0	0	0	14
05:15 PM	0	7	0	0	7	0	0	0	0	0	0	7	0	0	7	0	0	0	0	0	0	14
05:30 PM	0	5	0	0	5	0	0	0	0	0	0	9	0	0	9	0	0	0	0	0	0	14
05:45 PM	0	5	0	0	5	0	0	0	0	0	0	5	0	0	5	0	0	0	0	0	0	10
Total	1	23	0	0	24	0	0	0	0	0	0	28	0	0	28	0	0	0	0	0	0	52
Grand Total	2	67	0	0	69	0	0	0	0	0	0	75	2	0	77	1	0	0	0	0	1	147
Apprch %	2.9	97.1	0	0		0	0	0	0		0	97.4	2.6	0		100	0	0	0			
Total %	1.4	45.6	0	0	46.9	0	0	0	0	0	0	51	1.4	0	52.4	0.7	0	0	0	0	0.7	

Start Time	US 29 Southbound				Driveway Westbound				US 29 Northbound				Austin Dr Eastbound				Int. Total					
	Right	Thru	Left	App. Total	Right	Thru	Left	App. Total	Right	Thru	Left	App. Total	Right	Thru	Left	App. Total						
Peak Hour Analysis From 04:00 PM to 05:45 PM - Peak 1 of 1																						
Peak Hour for Entire Intersection Begins at 04:00 PM																						
04:00 PM	0	13	0	13	0	0	0	0	0	0	10	0	10	0	0	0	0	0	0	0	0	23
04:15 PM	0	12	0	12	0	0	0	0	0	0	11	0	11	0	0	0	0	0	0	0	0	23
04:30 PM	0	8	0	8	0	0	0	0	0	0	15	1	16	0	0	0	0	0	0	0	0	24
04:45 PM	1	11	0	12	0	0	0	0	0	0	11	1	12	1	0	0	0	0	0	1	1	25
Total Volume	1	44	0	45	0	0	0	0	0	0	47	2	49	1	0	0	0	0	0	1	95	
% App. Total	2.2	97.8	0		0	0	0		0	95.9	4.1		100	0	0							
PHF	.250	.846	.000	.865	.000	.000	.000	.000	.000	.000	.783	.500	.766	.250	.000	.000	.250				.950	

Peggy Malone & Associates

(888) 247-8602

File Name : 6_US 29 & Austin Dr PM
 Site Code :
 Start Date : 4/14/2021
 Page No : 1

Groups Printed- Combined

Start Time	US 29 Southbound					Driveway Westbound					US 29 Northbound					Austin Dr Eastbound					Int. Total
	Right	Thru	Left	Peds	App. Total	Right	Thru	Left	Peds	App. Total	Right	Thru	Left	Peds	App. Total	Right	Thru	Left	Peds	App. Total	
04:00 PM	2	213	0	0	215	0	0	0	0	0	0	415	3	0	418	4	0	4	0	8	641
04:15 PM	1	235	0	0	236	0	0	0	0	0	0	449	6	0	455	5	0	3	0	8	699
04:30 PM	5	265	0	0	270	0	0	0	0	0	0	453	8	0	461	10	0	0	0	10	741
04:45 PM	6	250	0	0	256	0	0	0	0	0	0	502	6	0	508	10	0	3	0	13	777
Total	14	963	0	0	977	0	0	0	0	0	0	1819	23	0	1842	29	0	10	0	39	2858
05:00 PM	3	199	0	0	202	0	0	0	0	0	0	500	6	0	506	9	0	3	0	12	720
05:15 PM	7	220	0	0	227	0	0	0	0	0	0	497	6	0	503	5	0	4	0	9	739
05:30 PM	5	199	0	0	204	0	0	0	0	0	0	427	12	0	439	5	0	0	0	5	648
05:45 PM	4	215	0	0	219	0	0	0	0	0	0	425	2	0	427	7	0	0	0	7	653
Total	19	833	0	0	852	0	0	0	0	0	0	1849	26	0	1875	26	0	7	0	33	2760
Grand Total	33	1796	0	0	1829	0	0	0	0	0	0	3668	49	0	3717	55	0	17	0	72	5618
Apprch %	1.8	98.2	0	0		0	0	0	0		0	98.7	1.3	0		76.4	0	23.6	0		
Total %	0.6	32	0	0	32.6	0	0	0	0	0	0	65.3	0.9	0	66.2	1	0	0.3	0	1.3	

Start Time	US 29 Southbound				Driveway Westbound				US 29 Northbound				Austin Dr Eastbound				Int. Total
	Right	Thru	Left	App. Total	Right	Thru	Left	App. Total	Right	Thru	Left	App. Total	Right	Thru	Left	App. Total	
Peak Hour Analysis From 04:00 PM to 05:45 PM - Peak 1 of 1																	
Peak Hour for Entire Intersection Begins at 04:30 PM																	
04:30 PM	5	265	0	270	0	0	0	0	0	453	8	461	10	0	0	10	741
04:45 PM	6	250	0	256	0	0	0	0	0	502	6	508	10	0	3	13	777
05:00 PM	3	199	0	202	0	0	0	0	0	500	6	506	9	0	3	12	720
05:15 PM	7	220	0	227	0	0	0	0	0	497	6	503	5	0	4	9	739
Total Volume	21	934	0	955	0	0	0	0	0	1952	26	1978	34	0	10	44	2977
% App. Total	2.2	97.8	0		0	0	0		0	98.7	1.3		77.3	0	22.7		
PHF	.750	.881	.000	.884	.000	.000	.000	.000	.000	.972	.813	.973	.850	.000	.625	.846	.958

Peggy Malone & Associates

(888) 247-8602

File Name : 7_US 29 & Boulders Rd_Briarwood Dr AM
 Site Code :
 Start Date : 4/14/2021
 Page No : 1

Groups Printed- Cars

Start Time	US 29 Southbound					Boulders Rd Westbound					US 29 Northbound					Briarwood Dr Eastbound					Int. Total
	Right	Thru	Left	Peds	App. Total	Right	Thru	Left	Peds	App. Total	Right	Thru	Left	Peds	App. Total	Right	Thru	Left	Peds	App. Total	
07:00 AM	16	412	27	0	455	4	0	4	0	8	38	116	4	0	158	18	5	5	0	28	649
07:15 AM	18	455	27	0	500	3	0	4	0	7	29	133	6	0	168	31	3	2	0	36	711
07:30 AM	9	483	21	0	513	2	0	3	0	5	44	126	12	0	182	32	6	9	0	47	747
07:45 AM	10	392	28	0	430	3	1	5	0	9	60	145	17	0	222	23	5	4	0	32	693
Total	53	1742	103	0	1898	12	1	16	0	29	171	520	39	0	730	104	19	20	0	143	2800
08:00 AM	8	333	31	0	372	0	0	3	0	3	68	155	12	0	235	24	5	3	0	32	642
08:15 AM	12	387	35	0	434	3	0	4	0	7	59	169	15	0	243	25	3	1	0	29	713
08:30 AM	9	337	24	0	370	3	0	7	0	10	55	139	13	0	207	16	4	5	0	25	612
08:45 AM	12	294	22	0	328	3	0	8	0	11	53	151	6	0	210	24	5	7	0	36	585
Total	41	1351	112	0	1504	9	0	22	0	31	235	614	46	0	895	89	17	16	0	122	2552
Grand Total	94	3093	215	0	3402	21	1	38	0	60	406	1134	85	0	1625	193	36	36	0	265	5352
Apprch %	2.8	90.9	6.3	0		35	1.7	63.3	0		25	69.8	5.2	0		72.8	13.6	13.6	0		
Total %	1.8	57.8	4	0	63.6	0.4	0	0.7	0	1.1	7.6	21.2	1.6	0	30.4	3.6	0.7	0.7	0	5	

Start Time	US 29 Southbound				Boulders Rd Westbound				US 29 Northbound				Briarwood Dr Eastbound				Int. Total
	Right	Thru	Left	App. Total	Right	Thru	Left	App. Total	Right	Thru	Left	App. Total	Right	Thru	Left	App. Total	
Peak Hour Analysis From 07:00 AM to 08:45 AM - Peak 1 of 1																	
Peak Hour for Entire Intersection Begins at 07:00 AM																	
07:00 AM	16	412	27	455	4	0	4	8	38	116	4	158	18	5	5	28	649
07:15 AM	18	455	27	500	3	0	4	7	29	133	6	168	31	3	2	36	711
07:30 AM	9	483	21	513	2	0	3	5	44	126	12	182	32	6	9	47	747
07:45 AM	10	392	28	430	3	1	5	9	60	145	17	222	23	5	4	32	693
Total Volume	53	1742	103	1898	12	1	16	29	171	520	39	730	104	19	20	143	2800
% App. Total	2.8	91.8	5.4		41.4	3.4	55.2		23.4	71.2	5.3		72.7	13.3	14		
PHF	.736	.902	.920	.925	.750	.250	.800	.806	.713	.897	.574	.822	.813	.792	.556	.761	.937

Peggy Malone & Associates

(888) 247-8602

File Name : 7_US 29 & Boulders Rd_Briarwood Dr AM
 Site Code :
 Start Date : 4/14/2021
 Page No : 1

Groups Printed- Trucks

Start Time	US 29 Southbound					Boulders Rd Westbound					US 29 Northbound					Briarwood Dr Eastbound					Int. Total
	Right	Thru	Left	Peds	App. Total	Right	Thru	Left	Peds	App. Total	Right	Thru	Left	Peds	App. Total	Right	Thru	Left	Peds	App. Total	
07:00 AM	0	13	0	0	13	0	0	0	0	0	0	20	1	0	21	1	0	1	0	2	36
07:15 AM	0	14	0	0	14	0	0	0	0	0	0	22	0	0	22	3	0	0	0	3	39
07:30 AM	0	17	0	0	17	0	0	0	0	0	0	12	0	0	12	0	0	0	0	0	29
07:45 AM	0	23	0	0	23	0	0	0	0	0	0	19	0	0	19	0	0	0	0	0	42
Total	0	67	0	0	67	0	0	0	0	0	0	73	1	0	74	4	0	1	0	5	146
08:00 AM	0	16	0	0	16	0	0	0	0	0	0	15	1	0	16	0	0	1	0	1	33
08:15 AM	1	13	0	0	14	0	0	0	0	0	0	20	0	0	20	0	0	0	0	0	34
08:30 AM	1	10	1	0	12	0	0	0	0	0	0	25	2	0	27	1	0	0	0	1	40
08:45 AM	0	20	1	0	21	0	0	0	0	0	0	10	0	0	10	0	0	1	0	1	32
Total	2	59	2	0	63	0	0	0	0	0	0	70	3	0	73	1	0	2	0	3	139
Grand Total	2	126	2	0	130	0	0	0	0	0	0	143	4	0	147	5	0	3	0	8	285
Apprch %	1.5	96.9	1.5	0		0	0	0	0		0	97.3	2.7	0		62.5	0	37.5	0		
Total %	0.7	44.2	0.7	0	45.6	0	0	0	0		0	50.2	1.4	0	51.6	1.8	0	1.1	0	2.8	

Start Time	US 29 Southbound				Boulders Rd Westbound				US 29 Northbound				Briarwood Dr Eastbound				Int. Total				
	Right	Thru	Left	App. Total	Right	Thru	Left	App. Total	Right	Thru	Left	App. Total	Right	Thru	Left	App. Total					
Peak Hour Analysis From 07:00 AM to 08:45 AM - Peak 1 of 1																					
Peak Hour for Entire Intersection Begins at 07:45 AM																					
07:45 AM	0	23	0	23	0	0	0	0	0	0	19	0	19	0	0	0	0	0	0	0	42
08:00 AM	0	16	0	16	0	0	0	0	0	0	15	1	16	0	0	1	1	1	1	1	33
08:15 AM	1	13	0	14	0	0	0	0	0	0	20	0	20	0	0	0	0	0	0	0	34
08:30 AM	1	10	1	12	0	0	0	0	0	0	25	2	27	1	0	0	1	0	1	1	40
Total Volume	2	62	1	65	0	0	0	0	0	0	79	3	82	1	0	1	2	2	2	149	
% App. Total	3.1	95.4	1.5		0	0	0		0	0	96.3	3.7		50	0	50					
PHF	.500	.674	.250	.707	.000	.000	.000	.000	.000	.000	.790	.375	.759	.250	.000	.250	.500	.500	.500	.500	.887

Peggy Malone & Associates

(888) 247-8602

File Name : 7_US 29 & Boulders Rd_Briarwood Dr AM
 Site Code :
 Start Date : 4/14/2021
 Page No : 1

Groups Printed- Combined

Start Time	US 29 Southbound					Boulders Rd Westbound					US 29 Northbound					Briarwood Dr Eastbound					Int. Total
	Right	Thru	Left	Peds	App. Total	Right	Thru	Left	Peds	App. Total	Right	Thru	Left	Peds	App. Total	Right	Thru	Left	Peds	App. Total	
07:00 AM	16	425	27	0	468	4	0	4	0	8	38	136	5	0	179	19	5	6	0	30	685
07:15 AM	18	469	27	0	514	3	0	4	0	7	29	155	6	0	190	34	3	2	0	39	750
07:30 AM	9	500	21	0	530	2	0	3	0	5	44	138	12	0	194	32	6	9	0	47	776
07:45 AM	10	415	28	0	453	3	1	5	0	9	60	164	17	0	241	23	5	4	0	32	735
Total	53	1809	103	0	1965	12	1	16	0	29	171	593	40	0	804	108	19	21	0	148	2946
08:00 AM	8	349	31	0	388	0	0	3	0	3	68	170	13	0	251	24	5	4	0	33	675
08:15 AM	13	400	35	0	448	3	0	4	0	7	59	189	15	0	263	25	3	1	0	29	747
08:30 AM	10	347	25	0	382	3	0	7	0	10	55	164	15	0	234	17	4	5	0	26	652
08:45 AM	12	314	23	0	349	3	0	8	0	11	53	161	6	0	220	24	5	8	0	37	617
Total	43	1410	114	0	1567	9	0	22	0	31	235	684	49	0	968	90	17	18	0	125	2691
Grand Total	96	3219	217	0	3532	21	1	38	0	60	406	1277	89	0	1772	198	36	39	0	273	5637
Apprch %	2.7	91.1	6.1	0		35	1.7	63.3	0		22.9	72.1	5	0		72.5	13.2	14.3	0		
Total %	1.7	57.1	3.8	0	62.7	0.4	0	0.7	0	1.1	7.2	22.7	1.6	0	31.4	3.5	0.6	0.7	0	4.8	

Start Time	US 29 Southbound				Boulders Rd Westbound				US 29 Northbound				Briarwood Dr Eastbound				Int. Total
	Right	Thru	Left	App. Total	Right	Thru	Left	App. Total	Right	Thru	Left	App. Total	Right	Thru	Left	App. Total	
Peak Hour Analysis From 07:00 AM to 08:45 AM - Peak 1 of 1																	
Peak Hour for Entire Intersection Begins at 07:00 AM																	
07:00 AM	16	425	27	468	4	0	4	8	38	136	5	179	19	5	6	30	685
07:15 AM	18	469	27	514	3	0	4	7	29	155	6	190	34	3	2	39	750
07:30 AM	9	500	21	530	2	0	3	5	44	138	12	194	32	6	9	47	776
07:45 AM	10	415	28	453	3	1	5	9	60	164	17	241	23	5	4	32	735
Total Volume	53	1809	103	1965	12	1	16	29	171	593	40	804	108	19	21	148	2946
% App. Total	2.7	92.1	5.2		41.4	3.4	55.2		21.3	73.8	5		73	12.8	14.2		
PHF	.736	.905	.920	.927	.750	.250	.800	.806	.713	.904	.588	.834	.794	.792	.583	.787	.949

Peggy Malone & Associates

(888) 247-8602

File Name : 7_US 29 & Boulders Rd_Briarwood Dr PM
 Site Code :
 Start Date : 4/14/2021
 Page No : 1

Groups Printed- Cars

Start Time	US 29 Southbound					Boulders Rd Westbound					US 29 Northbound					Briarwood Dr Eastbound					Int. Total
	Right	Thru	Left	Peds	App. Total	Right	Thru	Left	Peds	App. Total	Right	Thru	Left	Peds	App. Total	Right	Thru	Left	Peds	App. Total	
04:00 PM	6	212	1	0	219	26	3	69	0	98	5	392	29	0	426	21	1	9	0	31	774
04:15 PM	7	201	0	0	208	25	3	47	0	75	3	389	28	0	420	13	0	10	0	23	726
04:30 PM	8	263	1	0	272	26	1	37	0	64	1	436	26	0	463	13	1	8	0	22	821
04:45 PM	13	234	0	0	247	16	4	39	0	59	8	440	28	0	476	20	2	12	0	34	816
Total	34	910	2	0	946	93	11	192	0	296	17	1657	111	0	1785	67	4	39	0	110	3137
05:00 PM	5	212	2	0	219	14	4	37	0	55	1	502	25	0	528	15	1	5	0	21	823
05:15 PM	6	208	2	0	216	26	3	30	0	59	3	450	36	0	489	25	0	12	0	37	801
05:30 PM	7	203	7	0	217	9	1	30	0	40	2	444	22	0	468	13	0	3	0	16	741
05:45 PM	8	205	2	0	215	8	2	20	0	30	2	391	23	0	416	12	0	7	0	19	680
Total	26	828	13	0	867	57	10	117	0	184	8	1787	106	0	1901	65	1	27	0	93	3045
Grand Total	60	1738	15	0	1813	150	21	309	0	480	25	3444	217	0	3686	132	5	66	0	203	6182
Apprch %	3.3	95.9	0.8	0		31.2	4.4	64.4	0		0.7	93.4	5.9	0		65	2.5	32.5	0		
Total %	1	28.1	0.2	0	29.3	2.4	0.3	5	0	7.8	0.4	55.7	3.5	0	59.6	2.1	0.1	1.1	0	3.3	

Start Time	US 29 Southbound				Boulders Rd Westbound				US 29 Northbound				Briarwood Dr Eastbound				Int. Total
	Right	Thru	Left	App. Total	Right	Thru	Left	App. Total	Right	Thru	Left	App. Total	Right	Thru	Left	App. Total	
Peak Hour Analysis From 04:00 PM to 05:45 PM - Peak 1 of 1																	
Peak Hour for Entire Intersection Begins at 04:30 PM																	
04:30 PM	8	263	1	272	26	1	37	64	1	436	26	463	13	1	8	22	821
04:45 PM	13	234	0	247	16	4	39	59	8	440	28	476	20	2	12	34	816
05:00 PM	5	212	2	219	14	4	37	55	1	502	25	528	15	1	5	21	823
05:15 PM	6	208	2	216	26	3	30	59	3	450	36	489	25	0	12	37	801
Total Volume	32	917	5	954	82	12	143	237	13	1828	115	1956	73	4	37	114	3261
% App. Total	3.4	96.1	0.5		34.6	5.1	60.3		0.7	93.5	5.9		64	3.5	32.5		
PHF	.615	.872	.625	.877	.788	.750	.917	.926	.406	.910	.799	.926	.730	.500	.771	.770	.991

Peggy Malone & Associates

(888) 247-8602

File Name : 7_US 29 & Boulders Rd_Briarwood Dr PM
 Site Code :
 Start Date : 4/14/2021
 Page No : 1

Groups Printed- Trucks

Start Time	US 29 Southbound					Boulders Rd Westbound					US 29 Northbound					Briarwood Dr Eastbound					Int. Total	
	Right	Thru	Left	Peds	App. Total	Right	Thru	Left	Peds	App. Total	Right	Thru	Left	Peds	App. Total	Right	Thru	Left	Peds	App. Total		
04:00 PM	0	14	0	0	14	0	0	0	0	0	0	11	0	0	11	2	0	0	0	0	2	27
04:15 PM	0	13	0	0	13	0	0	0	0	0	0	10	0	0	10	0	0	0	0	0	0	23
04:30 PM	0	6	0	0	6	0	0	0	0	0	0	16	2	0	18	2	0	0	0	0	2	26
04:45 PM	0	12	0	0	12	0	0	0	0	0	0	13	0	0	13	3	0	0	0	0	3	28
Total	0	45	0	0	45	0	0	0	0	0	0	50	2	0	52	7	0	0	0	0	7	104
05:00 PM	1	6	0	0	7	0	0	0	0	0	0	7	0	0	7	1	0	0	0	0	1	15
05:15 PM	0	6	0	0	6	0	0	0	0	0	0	6	1	0	7	0	0	0	0	0	0	13
05:30 PM	0	7	0	0	7	0	0	0	0	0	0	9	0	0	9	0	0	0	0	0	0	16
05:45 PM	0	5	0	0	5	0	0	0	0	0	0	5	0	0	5	0	0	0	0	0	0	10
Total	1	24	0	0	25	0	0	0	0	0	0	27	1	0	28	1	0	0	0	0	1	54
Grand Total	1	69	0	0	70	0	0	0	0	0	0	77	3	0	80	8	0	0	0	0	8	158
Apprch %	1.4	98.6	0	0		0	0	0	0		0	96.2	3.8	0		100	0	0	0			
Total %	0.6	43.7	0	0	44.3	0	0	0	0		0	48.7	1.9	0	50.6	5.1	0	0	0		5.1	

Start Time	US 29 Southbound				Boulders Rd Westbound				US 29 Northbound				Briarwood Dr Eastbound				Int. Total	
	Right	Thru	Left	App. Total	Right	Thru	Left	App. Total	Right	Thru	Left	App. Total	Right	Thru	Left	App. Total		
Peak Hour Analysis From 04:00 PM to 05:45 PM - Peak 1 of 1																		
Peak Hour for Entire Intersection Begins at 04:00 PM																		
04:00 PM	0	14	0	14	0	0	0	0	0	0	11	0	11	2	0	0	2	27
04:15 PM	0	13	0	13	0	0	0	0	0	0	10	0	10	0	0	0	0	23
04:30 PM	0	6	0	6	0	0	0	0	0	0	16	2	18	2	0	0	2	26
04:45 PM	0	12	0	12	0	0	0	0	0	0	13	0	13	3	0	0	3	28
Total Volume	0	45	0	45	0	0	0	0	0	0	50	2	52	7	0	0	7	104
% App. Total	0	100	0		0	0	0		0	0	96.2	3.8		100	0	0		
PHF	.000	.804	.000	.804	.000	.000	.000	.000	.000	.000	.781	.250	.722	.583	.000	.000	.583	.929

Peggy Malone & Associates

(888) 247-8602

File Name : 7_US 29 & Boulders Rd_Briarwood Dr PM
 Site Code :
 Start Date : 4/14/2021
 Page No : 1

Groups Printed- Combined

Start Time	US 29 Southbound					Boulders Rd Westbound					US 29 Northbound					Briarwood Dr Eastbound					Int. Total
	Right	Thru	Left	Peds	App. Total	Right	Thru	Left	Peds	App. Total	Right	Thru	Left	Peds	App. Total	Right	Thru	Left	Peds	App. Total	
04:00 PM	6	226	1	0	233	26	3	69	0	98	5	403	29	0	437	23	1	9	0	33	801
04:15 PM	7	214	0	0	221	25	3	47	0	75	3	399	28	0	430	13	0	10	0	23	749
04:30 PM	8	269	1	0	278	26	1	37	0	64	1	452	28	0	481	15	1	8	0	24	847
04:45 PM	13	246	0	0	259	16	4	39	0	59	8	453	28	0	489	23	2	12	0	37	844
Total	34	955	2	0	991	93	11	192	0	296	17	1707	113	0	1837	74	4	39	0	117	3241
05:00 PM	6	218	2	0	226	14	4	37	0	55	1	509	25	0	535	16	1	5	0	22	838
05:15 PM	6	214	2	0	222	26	3	30	0	59	3	456	37	0	496	25	0	12	0	37	814
05:30 PM	7	210	7	0	224	9	1	30	0	40	2	453	22	0	477	13	0	3	0	16	757
05:45 PM	8	210	2	0	220	8	2	20	0	30	2	396	23	0	421	12	0	7	0	19	690
Total	27	852	13	0	892	57	10	117	0	184	8	1814	107	0	1929	66	1	27	0	94	3099
Grand Total	61	1807	15	0	1883	150	21	309	0	480	25	3521	220	0	3766	140	5	66	0	211	6340
Apprch %	3.2	96	0.8	0		31.2	4.4	64.4	0		0.7	93.5	5.8	0		66.4	2.4	31.3	0		
Total %	1	28.5	0.2	0	29.7	2.4	0.3	4.9	0	7.6	0.4	55.5	3.5	0	59.4	2.2	0.1	1	0	3.3	

Start Time	US 29 Southbound				Boulders Rd Westbound				US 29 Northbound				Briarwood Dr Eastbound				Int. Total
	Right	Thru	Left	App. Total	Right	Thru	Left	App. Total	Right	Thru	Left	App. Total	Right	Thru	Left	App. Total	
Peak Hour Analysis From 04:00 PM to 05:45 PM - Peak 1 of 1																	
Peak Hour for Entire Intersection Begins at 04:30 PM																	
04:30 PM	8	269	1	278	26	1	37	64	1	452	28	481	15	1	8	24	847
04:45 PM	13	246	0	259	16	4	39	59	8	453	28	489	23	2	12	37	844
05:00 PM	6	218	2	226	14	4	37	55	1	509	25	535	16	1	5	22	838
05:15 PM	6	214	2	222	26	3	30	59	3	456	37	496	25	0	12	37	814
Total Volume	33	947	5	985	82	12	143	237	13	1870	118	2001	79	4	37	120	3343
% App. Total	3.4	96.1	0.5		34.6	5.1	60.3		0.6	93.5	5.9		65.8	3.3	30.8		
PHF	.635	.880	.625	.886	.788	.750	.917	.926	.406	.918	.797	.935	.790	.500	.771	.811	.987

Peggy Malone & Associates

(888) 247-8602

File Name : 8_US 29 & Camelot Dr AM
 Site Code :
 Start Date : 4/13/2021
 Page No : 1

Groups Printed- Cars

Start Time	US 29 Southbound					Driveway Westbound					US 29 Northbound					Camelot Dr Eastbound					Int. Total
	Right	Thru	Left	Peds	App. Total	Right	Thru	Left	Peds	App. Total	Right	Thru	Left	Peds	App. Total	Right	Thru	Left	Peds	App. Total	
07:00 AM	0	383	1	0	384	0	0	0	0	0	2	173	1	0	176	13	0	2	0	15	575
07:15 AM	1	517	4	0	522	0	0	1	0	1	1	163	7	0	171	9	0	2	0	11	705
07:30 AM	0	526	5	0	531	0	0	2	0	2	0	176	3	0	179	9	0	0	0	9	721
07:45 AM	2	433	3	0	438	0	0	1	0	1	3	229	7	0	239	9	0	2	0	11	689
Total	3	1859	13	0	1875	0	0	4	0	4	6	741	18	0	765	40	0	6	0	46	2690
08:00 AM	0	370	3	0	373	0	0	1	0	1	2	217	5	0	224	11	0	1	0	12	610
08:15 AM	2	380	2	0	384	1	0	1	0	2	1	213	7	0	221	8	0	2	0	10	617
08:30 AM	3	362	3	0	368	0	0	1	0	1	3	204	3	0	210	11	0	2	0	13	592
08:45 AM	1	357	2	0	360	0	0	0	0	0	3	218	5	0	226	7	0	1	0	8	594
Total	6	1469	10	0	1485	1	0	3	0	4	9	852	20	0	881	37	0	6	0	43	2413
Grand Total	9	3328	23	0	3360	1	0	7	0	8	15	1593	38	0	1646	77	0	12	0	89	5103
Apprch %	0.3	99	0.7	0		12.5	0	87.5	0		0.9	96.8	2.3	0		86.5	0	13.5	0		
Total %	0.2	65.2	0.5	0	65.8	0	0	0.1	0	0.2	0.3	31.2	0.7	0	32.3	1.5	0	0.2	0	1.7	

Start Time	US 29 Southbound				Driveway Westbound				US 29 Northbound				Camelot Dr Eastbound				Int. Total
	Right	Thru	Left	App. Total	Right	Thru	Left	App. Total	Right	Thru	Left	App. Total	Right	Thru	Left	App. Total	
Peak Hour Analysis From 07:00 AM to 08:45 AM - Peak 1 of 1																	
Peak Hour for Entire Intersection Begins at 07:15 AM																	
07:15 AM	1	517	4	522	0	0	1	1	1	163	7	171	9	0	2	11	705
07:30 AM	0	526	5	531	0	0	2	2	0	176	3	179	9	0	0	9	721
07:45 AM	2	433	3	438	0	0	1	1	3	229	7	239	9	0	2	11	689
08:00 AM	0	370	3	373	0	0	1	1	2	217	5	224	11	0	1	12	610
Total Volume	3	1846	15	1864	0	0	5	5	6	785	22	813	38	0	5	43	2725
% App. Total	0.2	99	0.8		0	0	100		0.7	96.6	2.7		88.4	0	11.6		
PHF	.375	.877	.750	.878	.000	.000	.625	.625	.500	.857	.786	.850	.864	.000	.625	.896	.945

Peggy Malone & Associates

(888) 247-8602

File Name : 8_US 29 & Camelot Dr AM
 Site Code :
 Start Date : 4/13/2021
 Page No : 1

Groups Printed- Trucks

Start Time	US 29 Southbound					Driveway Westbound					US 29 Northbound					Camelot Dr Eastbound					Int. Total
	Right	Thru	Left	Peds	App. Total	Right	Thru	Left	Peds	App. Total	Right	Thru	Left	Peds	App. Total	Right	Thru	Left	Peds	App. Total	
07:00 AM	0	18	0	0	18	1	0	0	0	1	0	16	0	0	16	0	0	0	0	0	0
07:15 AM	1	30	0	0	31	0	0	0	0	0	0	21	1	0	22	3	0	0	0	3	3
07:30 AM	1	15	0	0	16	0	0	0	0	0	0	12	0	0	12	0	0	1	0	1	1
07:45 AM	0	14	0	0	14	2	0	0	0	2	0	20	0	0	20	0	0	0	0	0	0
Total	2	77	0	0	79	3	0	0	0	3	0	69	1	0	70	3	0	1	0	4	156
08:00 AM	0	20	0	0	20	0	0	0	0	0	1	13	0	0	14	0	0	0	0	0	0
08:15 AM	0	18	0	0	18	0	0	0	0	0	1	23	0	0	24	0	0	0	0	0	0
08:30 AM	0	24	0	0	24	1	0	0	0	1	0	20	0	0	20	0	0	0	0	0	0
08:45 AM	0	18	0	0	18	1	0	0	0	1	0	25	0	0	25	0	0	0	0	0	0
Total	0	80	0	0	80	2	0	0	0	2	2	81	0	0	83	0	0	0	0	0	165
Grand Total	2	157	0	0	159	5	0	0	0	5	2	150	1	0	153	3	0	1	0	4	321
Apprch %	1.3	98.7	0	0		100	0	0	0		1.3	98	0.7	0		75	0	25	0		
Total %	0.6	48.9	0	0	49.5	1.6	0	0	0	1.6	0.6	46.7	0.3	0	47.7	0.9	0	0.3	0	1.2	

Start Time	US 29 Southbound				Driveway Westbound				US 29 Northbound				Camelot Dr Eastbound				Int. Total
	Right	Thru	Left	App. Total	Right	Thru	Left	App. Total	Right	Thru	Left	App. Total	Right	Thru	Left	App. Total	
Peak Hour Analysis From 07:00 AM to 08:45 AM - Peak 1 of 1																	
Peak Hour for Entire Intersection Begins at 08:00 AM																	
08:00 AM	0	20	0	20	0	0	0	0	1	13	0	14	0	0	0	0	34
08:15 AM	0	18	0	18	0	0	0	0	1	23	0	24	0	0	0	0	42
08:30 AM	0	24	0	24	1	0	0	1	0	20	0	20	0	0	0	0	45
08:45 AM	0	18	0	18	1	0	0	1	0	25	0	25	0	0	0	0	44
Total Volume	0	80	0	80	2	0	0	2	2	81	0	83	0	0	0	0	165
% App. Total	0	100	0		100	0	0		2.4	97.6	0		0	0	0		
PHF	.000	.833	.000	.833	.500	.000	.000	.500	.500	.810	.000	.830	.000	.000	.000	.000	.917

Peggy Malone & Associates

(888) 247-8602

File Name : 8_US 29 & Camelot Dr AM
 Site Code :
 Start Date : 4/13/2021
 Page No : 1

Groups Printed- Combined

Start Time	US 29 Southbound					Driveway Westbound					US 29 Northbound					Camelot Dr Eastbound					Int. Total
	Right	Thru	Left	Peds	App. Total	Right	Thru	Left	Peds	App. Total	Right	Thru	Left	Peds	App. Total	Right	Thru	Left	Peds	App. Total	
07:00 AM	0	401	1	0	402	1	0	0	0	1	2	189	1	0	192	13	0	2	0	15	610
07:15 AM	2	547	4	0	553	0	0	1	0	1	1	184	8	0	193	12	0	2	0	14	761
07:30 AM	1	541	5	0	547	0	0	2	0	2	0	188	3	0	191	9	0	1	0	10	750
07:45 AM	2	447	3	0	452	2	0	1	0	3	3	249	7	0	259	9	0	2	0	11	725
Total	5	1936	13	0	1954	3	0	4	0	7	6	810	19	0	835	43	0	7	0	50	2846
08:00 AM	0	390	3	0	393	0	0	1	0	1	3	230	5	0	238	11	0	1	0	12	644
08:15 AM	2	398	2	0	402	1	0	1	0	2	2	236	7	0	245	8	0	2	0	10	659
08:30 AM	3	386	3	0	392	1	0	1	0	2	3	224	3	0	230	11	0	2	0	13	637
08:45 AM	1	375	2	0	378	1	0	0	0	1	3	243	5	0	251	7	0	1	0	8	638
Total	6	1549	10	0	1565	3	0	3	0	6	11	933	20	0	964	37	0	6	0	43	2578
Grand Total	11	3485	23	0	3519	6	0	7	0	13	17	1743	39	0	1799	80	0	13	0	93	5424
Apprch %	0.3	99	0.7	0		46.2	0	53.8	0		0.9	96.9	2.2	0		86	0	14	0		
Total %	0.2	64.3	0.4	0	64.9	0.1	0	0.1	0	0.2	0.3	32.1	0.7	0	33.2	1.5	0	0.2	0	1.7	

Start Time	US 29 Southbound				Driveway Westbound				US 29 Northbound				Camelot Dr Eastbound				Int. Total
	Right	Thru	Left	App. Total	Right	Thru	Left	App. Total	Right	Thru	Left	App. Total	Right	Thru	Left	App. Total	
Peak Hour Analysis From 07:00 AM to 08:45 AM - Peak 1 of 1																	
Peak Hour for Entire Intersection Begins at 07:15 AM																	
07:15 AM	2	547	4	553	0	0	1	1	1	184	8	193	12	0	2	14	761
07:30 AM	1	541	5	547	0	0	2	2	0	188	3	191	9	0	1	10	750
07:45 AM	2	447	3	452	2	0	1	3	3	249	7	259	9	0	2	11	725
08:00 AM	0	390	3	393	0	0	1	1	3	230	5	238	11	0	1	12	644
Total Volume	5	1925	15	1945	2	0	5	7	7	851	23	881	41	0	6	47	2880
% App. Total	0.3	99	0.8		28.6	0	71.4		0.8	96.6	2.6		87.2	0	12.8		
PHF	.625	.880	.750	.879	.250	.000	.625	.583	.583	.854	.719	.850	.854	.000	.750	.839	.946

Peggy Malone & Associates

(888) 247-8602

File Name : 8_US 29 & Camelot Dr PM
 Site Code :
 Start Date : 4/13/2021
 Page No : 1

Groups Printed- Cars

Start Time	US 29 Southbound					Driveway Westbound					US 29 Northbound					Camelot Dr Eastbound					Int. Total
	Right	Thru	Left	Peds	App. Total	Right	Thru	Left	Peds	App. Total	Right	Thru	Left	Peds	App. Total	Right	Thru	Left	Peds	App. Total	
04:00 PM	4	304	0	0	308	3	0	0	0	3	0	382	11	0	393	8	0	1	0	9	713
04:15 PM	3	260	0	0	263	4	0	3	0	7	0	402	12	0	414	12	0	0	0	12	696
04:30 PM	1	302	0	0	303	4	0	4	0	8	0	422	19	0	441	4	0	1	0	5	757
04:45 PM	2	263	1	0	266	2	0	1	0	3	2	432	14	0	448	13	0	1	0	14	731
Total	10	1129	1	0	1140	13	0	8	0	21	2	1638	56	0	1696	37	0	3	0	40	2897
05:00 PM	1	293	0	0	294	6	0	3	0	9	1	537	18	0	556	8	0	1	0	9	868
05:15 PM	1	271	0	0	272	0	0	2	0	2	0	526	23	0	549	6	0	0	0	6	829
05:30 PM	1	234	0	0	235	1	0	1	0	2	0	451	22	0	473	7	0	0	0	7	717
05:45 PM	1	231	0	0	232	0	0	0	0	0	1	376	19	0	396	14	0	0	0	14	642
Total	4	1029	0	0	1033	7	0	6	0	13	2	1890	82	0	1974	35	0	1	0	36	3056
Grand Total	14	2158	1	0	2173	20	0	14	0	34	4	3528	138	0	3670	72	0	4	0	76	5953
Apprch %	0.6	99.3	0	0		58.8	0	41.2	0		0.1	96.1	3.8	0		94.7	0	5.3	0		
Total %	0.2	36.3	0	0	36.5	0.3	0	0.2	0	0.6	0.1	59.3	2.3	0	61.6	1.2	0	0.1	0	1.3	

Start Time	US 29 Southbound				Driveway Westbound				US 29 Northbound				Camelot Dr Eastbound				Int. Total
	Right	Thru	Left	App. Total	Right	Thru	Left	App. Total	Right	Thru	Left	App. Total	Right	Thru	Left	App. Total	
Peak Hour Analysis From 04:00 PM to 05:45 PM - Peak 1 of 1																	
Peak Hour for Entire Intersection Begins at 04:30 PM																	
04:30 PM	1	302	0	303	4	0	4	8	0	422	19	441	4	0	1	5	757
04:45 PM	2	263	1	266	2	0	1	3	2	432	14	448	13	0	1	14	731
05:00 PM	1	293	0	294	6	0	3	9	1	537	18	556	8	0	1	9	868
05:15 PM	1	271	0	272	0	0	2	2	0	526	23	549	6	0	0	6	829
Total Volume	5	1129	1	1135	12	0	10	22	3	1917	74	1994	31	0	3	34	3185
% App. Total	0.4	99.5	0.1		54.5	0	45.5		0.2	96.1	3.7		91.2	0	8.8		
PHF	.625	.935	.250	.936	.500	.000	.625	.611	.375	.892	.804	.897	.596	.000	.750	.607	.917

Peggy Malone & Associates

(888) 247-8602

File Name : 8_US 29 & Camelot Dr PM
 Site Code :
 Start Date : 4/13/2021
 Page No : 1

Groups Printed- Trucks

Start Time	US 29 Southbound					Driveway Westbound					US 29 Northbound					Camelot Dr Eastbound					Int. Total
	Right	Thru	Left	Peds	App. Total	Right	Thru	Left	Peds	App. Total	Right	Thru	Left	Peds	App. Total	Right	Thru	Left	Peds	App. Total	
04:00 PM	0	13	0	0	13	0	0	0	0	0	1	17	1	0	19	0	0	0	0	0	0
04:15 PM	0	11	1	0	12	0	0	1	0	1	1	11	0	0	12	1	0	0	0	1	1
04:30 PM	1	22	0	0	23	2	0	0	0	2	1	15	0	0	16	0	0	0	0	0	0
04:45 PM	0	9	0	0	9	0	0	0	0	0	0	18	1	0	19	1	0	0	0	1	1
Total	1	55	1	0	57	2	0	1	0	3	3	61	2	0	66	2	0	0	0	2	128
05:00 PM	0	11	0	0	11	0	0	0	0	0	0	9	0	0	9	0	0	0	0	0	0
05:15 PM	0	4	0	0	4	0	0	0	0	0	0	8	0	0	8	0	0	0	0	0	0
05:30 PM	0	5	0	0	5	0	0	0	0	0	0	5	0	0	5	0	0	0	0	0	0
05:45 PM	0	6	0	0	6	0	0	0	0	0	0	4	0	0	4	0	0	0	0	0	0
Total	0	26	0	0	26	0	0	0	0	0	0	26	0	0	26	0	0	0	0	0	52
Grand Total	1	81	1	0	83	2	0	1	0	3	3	87	2	0	92	2	0	0	0	2	180
Apprch %	1.2	97.6	1.2	0		66.7	0	33.3	0		3.3	94.6	2.2	0		100	0	0	0		
Total %	0.6	45	0.6	0	46.1	1.1	0	0.6	0	1.7	1.7	48.3	1.1	0	51.1	1.1	0	0	0	1.1	

Start Time	US 29 Southbound				Driveway Westbound				US 29 Northbound				Camelot Dr Eastbound				Int. Total
	Right	Thru	Left	App. Total	Right	Thru	Left	App. Total	Right	Thru	Left	App. Total	Right	Thru	Left	App. Total	
Peak Hour Analysis From 04:00 PM to 05:45 PM - Peak 1 of 1																	
Peak Hour for Entire Intersection Begins at 04:00 PM																	
04:00 PM	0	13	0	13	0	0	0	0	1	17	1	19	0	0	0	0	0
04:15 PM	0	11	1	12	0	0	1	1	1	11	0	12	1	0	0	1	1
04:30 PM	1	22	0	23	2	0	0	2	1	15	0	16	0	0	0	0	0
04:45 PM	0	9	0	9	0	0	0	0	0	18	1	19	1	0	0	1	1
Total Volume	1	55	1	57	2	0	1	3	3	61	2	66	2	0	0	2	128
% App. Total	1.8	96.5	1.8		66.7	0	33.3		4.5	92.4	3		100	0	0		
PHF	.250	.625	.250	.620	.250	.000	.250	.375	.750	.847	.500	.868	.500	.000	.000	.500	.780

Peggy Malone & Associates

(888) 247-8602

File Name : 8_US 29 & Camelot Dr PM
 Site Code :
 Start Date : 4/13/2021
 Page No : 1

Groups Printed- Combined

Start Time	US 29 Southbound					Driveway Westbound					US 29 Northbound					Camelot Dr Eastbound					Int. Total
	Right	Thru	Left	Peds	App. Total	Right	Thru	Left	Peds	App. Total	Right	Thru	Left	Peds	App. Total	Right	Thru	Left	Peds	App. Total	
04:00 PM	4	317	0	0	321	3	0	0	0	3	1	399	12	0	412	8	0	1	0	9	745
04:15 PM	3	271	1	0	275	4	0	4	0	8	1	413	12	0	426	13	0	0	0	13	722
04:30 PM	2	324	0	0	326	6	0	4	0	10	1	437	19	0	457	4	0	1	0	5	798
04:45 PM	2	272	1	0	275	2	0	1	0	3	2	450	15	0	467	14	0	1	0	15	760
Total	11	1184	2	0	1197	15	0	9	0	24	5	1699	58	0	1762	39	0	3	0	42	3025
05:00 PM	1	304	0	0	305	6	0	3	0	9	1	546	18	0	565	8	0	1	0	9	888
05:15 PM	1	275	0	0	276	0	0	2	0	2	0	534	23	0	557	6	0	0	0	6	841
05:30 PM	1	239	0	0	240	1	0	1	0	2	0	456	22	0	478	7	0	0	0	7	727
05:45 PM	1	237	0	0	238	0	0	0	0	0	1	380	19	0	400	14	0	0	0	14	652
Total	4	1055	0	0	1059	7	0	6	0	13	2	1916	82	0	2000	35	0	1	0	36	3108
Grand Total	15	2239	2	0	2256	22	0	15	0	37	7	3615	140	0	3762	74	0	4	0	78	6133
Apprch %	0.7	99.2	0.1	0		59.5	0	40.5	0		0.2	96.1	3.7	0		94.9	0	5.1	0		
Total %	0.2	36.5	0	0	36.8	0.4	0	0.2	0	0.6	0.1	58.9	2.3	0	61.3	1.2	0	0.1	0	1.3	

Start Time	US 29 Southbound					Driveway Westbound					US 29 Northbound					Camelot Dr Eastbound					Int. Total
	Right	Thru	Left	Peds	App. Total	Right	Thru	Left	Peds	App. Total	Right	Thru	Left	Peds	App. Total	Right	Thru	Left	Peds	App. Total	
Peak Hour Analysis From 04:00 PM to 05:45 PM - Peak 1 of 1																					
Peak Hour for Entire Intersection Begins at 04:30 PM																					
04:30 PM	2	324	0	0	326	6	0	4	0	10	1	437	19	0	457	4	0	1	0	5	798
04:45 PM	2	272	1	0	275	2	0	1	0	3	2	450	15	0	467	14	0	1	0	15	760
05:00 PM	1	304	0	0	305	6	0	3	0	9	1	546	18	0	565	8	0	1	0	9	888
05:15 PM	1	275	0	0	276	0	0	2	0	2	0	534	23	0	557	6	0	0	0	6	841
Total Volume	6	1175	1	0	1182	14	0	10	0	24	4	1967	75	0	2046	32	0	3	0	35	3287
% App. Total	0.5	99.4	0.1	0		58.3	0	41.7	0		0.2	96.1	3.7	0		91.4	0	8.6	0		
PHF	.750	.907	.250	.906		.583	.000	.625	.600		.500	.901	.815	.905		.571	.000	.750	.583		.925

Peggy Malone & Associates

(888) 247-8602

NOTE: Had to reset to record
4-14.

File Name : 9_US 29 & Lewis and Clark Dr AM
Site Code :
Start Date : 4/14/2021
Page No : 1

Groups Printed- Cars

Start Time	US 29 Southbound					US 29 Northbound				Lewis and Clark Dr Eastbound				Int. Total
	Right	Thru	Left	Peds	App. Total	Thru	Left	Peds	App. Total	Right	Left	Peds	App. Total	
07:00 AM	22	415	0	0	437	149	13	0	162	4	2	0	6	605
07:15 AM	28	461	1	0	490	194	8	0	202	1	2	0	3	695
07:30 AM	43	495	0	0	538	180	8	0	188	2	8	0	10	736
07:45 AM	41	398	0	0	439	220	22	0	242	2	6	0	8	689
Total	134	1769	1	0	1904	743	51	0	794	9	18	0	27	2725
08:00 AM	35	361	0	0	396	229	14	0	243	1	4	0	5	644
08:15 AM	25	396	0	0	421	235	7	0	242	2	14	0	16	679
08:30 AM	21	353	0	0	374	211	9	0	220	2	4	0	6	600
08:45 AM	16	337	0	0	353	211	10	0	221	0	4	0	4	578
Total	97	1447	0	0	1544	886	40	0	926	5	26	0	31	2501
Grand Total	231	3216	1	0	3448	1629	91	0	1720	14	44	0	58	5226
Apprch %	6.7	93.3	0	0		94.7	5.3	0		24.1	75.9	0		
Total %	4.4	61.5	0	0	66	31.2	1.7	0	32.9	0.3	0.8	0	1.1	

Start Time	US 29 Southbound				US 29 Northbound				Lewis and Clark Dr Eastbound				Int. Total
	Right	Thru	Left	App. Total	Thru	Left	App. Total	Right	Left	App. Total			
Peak Hour Analysis From 07:00 AM to 08:45 AM - Peak 1 of 1													
Peak Hour for Entire Intersection Begins at 07:15 AM													
07:15 AM	28	461	1	490	194	8	202	1	2	3	695		
07:30 AM	43	495	0	538	180	8	188	2	8	10	736		
07:45 AM	41	398	0	439	220	22	242	2	6	8	689		
08:00 AM	35	361	0	396	229	14	243	1	4	5	644		
Total Volume	147	1715	1	1863	823	52	875	6	20	26	2764		
% App. Total	7.9	92.1	0.1		94.1	5.9		23.1	76.9				
PHF	.855	.866	.250	.866	.898	.591	.900	.750	.625	.650	.939		

Peggy Malone & Associates

(888) 247-8602

File Name : 9_US 29 & Lewis and Clark Dr AM
 Site Code :
 Start Date : 4/14/2021
 Page No : 1

Groups Printed- Trucks

Start Time	US 29 Southbound					US 29 Northbound				Lewis and Clark Dr Eastbound				Int. Total
	Right	Thru	Left	Peds	App. Total	Thru	Left	Peds	App. Total	Right	Left	Peds	App. Total	
07:00 AM	1	12	0	0	13	19	0	0	19	0	2	0	2	34
07:15 AM	0	17	0	0	17	23	0	0	23	0	0	0	0	40
07:30 AM	1	16	0	0	17	9	0	0	9	0	0	0	0	26
07:45 AM	0	24	0	0	24	18	0	0	18	0	0	0	0	42
Total	2	69	0	0	71	69	0	0	69	0	2	0	2	142
08:00 AM	0	17	0	0	17	18	1	0	19	1	0	0	1	37
08:15 AM	0	13	0	0	13	14	0	0	14	0	1	0	1	28
08:30 AM	0	11	0	0	11	26	1	0	27	0	1	0	1	39
08:45 AM	0	20	0	0	20	9	1	0	10	0	2	0	2	32
Total	0	61	0	0	61	67	3	0	70	1	4	0	5	136
Grand Total	2	130	0	0	132	136	3	0	139	1	6	0	7	278
Apprch %	1.5	98.5	0	0		97.8	2.2	0		14.3	85.7	0		
Total %	0.7	46.8	0	0	47.5	48.9	1.1	0	50	0.4	2.2	0	2.5	

Start Time	US 29 Southbound				US 29 Northbound				Lewis and Clark Dr Eastbound				Int. Total
	Right	Thru	Left	App. Total	Thru	Left	App. Total	Right	Left	App. Total			
Peak Hour Analysis From 07:00 AM to 08:45 AM - Peak 1 of 1													
Peak Hour for Entire Intersection Begins at 07:45 AM													
07:45 AM	0	24	0	24	18	0	18	0	0	0	42		
08:00 AM	0	17	0	17	18	1	19	1	0	1	37		
08:15 AM	0	13	0	13	14	0	14	0	1	1	28		
08:30 AM	0	11	0	11	26	1	27	0	1	1	39		
Total Volume	0	65	0	65	76	2	78	1	2	3	146		
% App. Total	0	100	0		97.4	2.6		33.3	66.7				
PHF	.000	.677	.000	.677	.731	.500	.722	.250	.500	.750	.869		

Peggy Malone & Associates

(888) 247-8602

File Name : 9_US 29 & Lewis and Clark Dr AM
 Site Code :
 Start Date : 4/14/2021
 Page No : 1

Groups Printed- Combined

Start Time	US 29 Southbound					US 29 Northbound				Lewis and Clark Dr Eastbound				Int. Total
	Right	Thru	Left	Peds	App. Total	Thru	Left	Peds	App. Total	Right	Left	Peds	App. Total	
07:00 AM	23	427	0	0	450	168	13	0	181	4	4	0	8	639
07:15 AM	28	478	1	0	507	217	8	0	225	1	2	0	3	735
07:30 AM	44	511	0	0	555	189	8	0	197	2	8	0	10	762
07:45 AM	41	422	0	0	463	238	22	0	260	2	6	0	8	731
Total	136	1838	1	0	1975	812	51	0	863	9	20	0	29	2867
08:00 AM	35	378	0	0	413	247	15	0	262	2	4	0	6	681
08:15 AM	25	409	0	0	434	249	7	0	256	2	15	0	17	707
08:30 AM	21	364	0	0	385	237	10	0	247	2	5	0	7	639
08:45 AM	16	357	0	0	373	220	11	0	231	0	6	0	6	610
Total	97	1508	0	0	1605	953	43	0	996	6	30	0	36	2637
Grand Total	233	3346	1	0	3580	1765	94	0	1859	15	50	0	65	5504
Apprch %	6.5	93.5	0	0		94.9	5.1	0		23.1	76.9	0		
Total %	4.2	60.8	0	0	65	32.1	1.7	0	33.8	0.3	0.9	0	1.2	

Start Time	US 29 Southbound				US 29 Northbound			Lewis and Clark Dr Eastbound			Int. Total
	Right	Thru	Left	App. Total	Thru	Left	App. Total	Right	Left	App. Total	
Peak Hour Analysis From 07:00 AM to 08:45 AM - Peak 1 of 1											
Peak Hour for Entire Intersection Begins at 07:15 AM											
07:15 AM	28	478	1	507	217	8	225	1	2	3	735
07:30 AM	44	511	0	555	189	8	197	2	8	10	762
07:45 AM	41	422	0	463	238	22	260	2	6	8	731
08:00 AM	35	378	0	413	247	15	262	2	4	6	681
Total Volume	148	1789	1	1938	891	53	944	7	20	27	2909
% App. Total	7.6	92.3	0.1		94.4	5.6		25.9	74.1		
PHF	.841	.875	.250	.873	.902	.602	.901	.875	.625	.675	.954

Peggy Malone & Associates

(888) 247-8602

File Name : 9_US 29 & Lewis and Clark Dr PM
 Site Code :
 Start Date : 4/14/2021
 Page No : 1

Groups Printed- Cars

Start Time	US 29 Southbound					US 29 Northbound				Lewis and Clark Dr Eastbound				Int. Total
	Right	Thru	Left	Peds	App. Total	Thru	Left	Peds	App. Total	Right	Left	Peds	App. Total	
04:00 PM	6	305	0	0	311	386	0	0	386	15	35	0	50	747
04:15 PM	2	283	1	0	286	411	2	0	413	6	19	0	25	724
04:30 PM	13	268	0	0	281	412	5	0	417	14	56	0	70	768
04:45 PM	11	321	1	0	333	475	3	0	478	7	20	0	27	838
Total	32	1177	2	0	1211	1684	10	0	1694	42	130	0	172	3077
05:00 PM	6	259	0	0	265	475	1	0	476	17	41	0	58	799
05:15 PM	6	280	0	0	286	488	1	0	489	3	32	0	35	810
05:30 PM	8	219	1	0	228	450	1	0	451	5	19	0	24	703
05:45 PM	5	280	1	0	286	414	1	0	415	8	13	0	21	722
Total	25	1038	2	0	1065	1827	4	0	1831	33	105	0	138	3034
Grand Total	57	2215	4	0	2276	3511	14	0	3525	75	235	0	310	6111
Apprch %	2.5	97.3	0.2	0		99.6	0.4	0		24.2	75.8	0		
Total %	0.9	36.2	0.1	0	37.2	57.5	0.2	0	57.7	1.2	3.8	0	5.1	

Start Time	US 29 Southbound				US 29 Northbound			Lewis and Clark Dr Eastbound			Int. Total
	Right	Thru	Left	App. Total	Thru	Left	App. Total	Right	Left	App. Total	
Peak Hour Analysis From 04:00 PM to 05:45 PM - Peak 1 of 1											
Peak Hour for Entire Intersection Begins at 04:30 PM											
04:30 PM	13	268	0	281	412	5	417	14	56	70	768
04:45 PM	11	321	1	333	475	3	478	7	20	27	838
05:00 PM	6	259	0	265	475	1	476	17	41	58	799
05:15 PM	6	280	0	286	488	1	489	3	32	35	810
Total Volume	36	1128	1	1165	1850	10	1860	41	149	190	3215
% App. Total	3.1	96.8	0.1		99.5	0.5		21.6	78.4		
PHF	.692	.879	.250	.875	.948	.500	.951	.603	.665	.679	.959

Peggy Malone & Associates

(888) 247-8602

File Name : 9_US 29 & Lewis and Clark Dr PM
 Site Code :
 Start Date : 4/14/2021
 Page No : 1

Groups Printed- Trucks

Start Time	US 29 Southbound					US 29 Northbound				Lewis and Clark Dr Eastbound				Int. Total
	Right	Thru	Left	Peds	App. Total	Thru	Left	Peds	App. Total	Right	Left	Peds	App. Total	
04:00 PM	1	15	0	0	16	10	2	0	12	2	0	0	2	30
04:15 PM	0	14	0	0	14	11	0	0	11	0	0	0	0	25
04:30 PM	0	9	0	0	9	19	4	0	23	0	0	0	0	32
04:45 PM	0	13	0	0	13	10	1	0	11	1	0	0	1	25
Total	1	51	0	0	52	50	7	0	57	3	0	0	3	112
05:00 PM	0	5	0	0	5	8	1	0	9	2	0	0	2	16
05:15 PM	1	6	0	0	7	9	1	0	10	3	0	0	3	20
05:30 PM	2	2	0	0	4	7	1	0	8	0	0	0	0	12
05:45 PM	0	7	0	0	7	7	0	0	7	1	0	0	1	15
Total	3	20	0	0	23	31	3	0	34	6	0	0	6	63
Grand Total	4	71	0	0	75	81	10	0	91	9	0	0	9	175
Apprch %	5.3	94.7	0	0		89	11	0		100	0	0		
Total %	2.3	40.6	0	0	42.9	46.3	5.7	0	52	5.1	0	0	5.1	

Start Time	US 29 Southbound				US 29 Northbound				Lewis and Clark Dr Eastbound				Int. Total
	Right	Thru	Left	App. Total	Thru	Left	App. Total	Right	Left	App. Total			
Peak Hour Analysis From 04:00 PM to 05:45 PM - Peak 1 of 1													
Peak Hour for Entire Intersection Begins at 04:00 PM													
04:00 PM	1	15	0	16	10	2	12	2	0	2	30		
04:15 PM	0	14	0	14	11	0	11	0	0	0	25		
04:30 PM	0	9	0	9	19	4	23	0	0	0	32		
04:45 PM	0	13	0	13	10	1	11	1	0	1	25		
Total Volume	1	51	0	52	50	7	57	3	0	3	112		
% App. Total	1.9	98.1	0		87.7	12.3		100	0				
PHF	.250	.850	.000	.813	.658	.438	.620	.375	.000	.375	.875		

Peggy Malone & Associates

(888) 247-8602

File Name : 9_US 29 & Lewis and Clark Dr PM
 Site Code :
 Start Date : 4/14/2021
 Page No : 1

Groups Printed- Combined

Start Time	US 29 Southbound					US 29 Northbound				Lewis and Clark Dr Eastbound				Int. Total
	Right	Thru	Left	Peds	App. Total	Thru	Left	Peds	App. Total	Right	Left	Peds	App. Total	
04:00 PM	7	320	0	0	327	396	2	0	398	17	35	0	52	777
04:15 PM	2	297	1	0	300	422	2	0	424	6	19	0	25	749
04:30 PM	13	277	0	0	290	431	9	0	440	14	56	0	70	800
04:45 PM	11	334	1	0	346	485	4	0	489	8	20	0	28	863
Total	33	1228	2	0	1263	1734	17	0	1751	45	130	0	175	3189
05:00 PM	6	264	0	0	270	483	2	0	485	19	41	0	60	815
05:15 PM	7	286	0	0	293	497	2	0	499	6	32	0	38	830
05:30 PM	10	221	1	0	232	457	2	0	459	5	19	0	24	715
05:45 PM	5	287	1	0	293	421	1	0	422	9	13	0	22	737
Total	28	1058	2	0	1088	1858	7	0	1865	39	105	0	144	3097
Grand Total	61	2286	4	0	2351	3592	24	0	3616	84	235	0	319	6286
Apprch %	2.6	97.2	0.2	0		99.3	0.7	0		26.3	73.7	0		
Total %	1	36.4	0.1	0	37.4	57.1	0.4	0	57.5	1.3	3.7	0	5.1	

Start Time	US 29 Southbound				US 29 Northbound				Lewis and Clark Dr Eastbound				Int. Total	
	Right	Thru	Left	App. Total	Thru	Left	App. Total	Right	Left	App. Total				
Peak Hour Analysis From 04:00 PM to 05:45 PM - Peak 1 of 1														
Peak Hour for Entire Intersection Begins at 04:30 PM														
04:30 PM	13	277	0	290	431	9	440	14	56	70	800			
04:45 PM	11	334	1	346	485	4	489	8	20	28	863			
05:00 PM	6	264	0	270	483	2	485	19	41	60	815			
05:15 PM	7	286	0	293	497	2	499	6	32	38	830			
Total Volume	37	1161	1	1199	1896	17	1913	47	149	196	3308			
% App. Total	3.1	96.8	0.1		99.1	0.9		24	76					
PHF	.712	.869	.250	.866	.954	.472	.958	.618	.665	.700	.958			

Peggy Malone & Associates
904-992-8072

File Name : 14_US 29 Median Cut North of Cyress Dr AM
 Site Code :
 Start Date : 4/20/2021
 Page No : 1

Groups Printed- Cars

Start Time	US 29 Southbound				US 29 Northbound				Int. Total
	Thru	Left	Peds	App. Total	Thru	Left	Peds	App. Total	
07:00 AM	411	0	0	411	164	4	0	168	579
07:15 AM	471	0	0	471	198	3	0	201	672
07:30 AM	530	0	0	530	181	2	0	183	713
07:45 AM	481	0	0	481	243	5	0	248	729
Total	1893	0	0	1893	786	14	0	800	2693
08:00 AM	393	0	0	393	242	5	0	247	640
08:15 AM	383	0	0	383	218	1	0	219	602
08:30 AM	328	0	0	328	205	4	0	209	537
08:45 AM	333	0	0	333	217	1	0	218	551
Total	1437	0	0	1437	882	11	0	893	2330
Grand Total	3330	0	0	3330	1668	25	0	1693	5023
Apprch %	100	0	0		98.5	1.5	0		
Total %	66.3	0	0	66.3	33.2	0.5	0	33.7	

Peggy Malone & Associates
904-992-8072

File Name : 14_US 29 Median Cut North of Cyress Dr AM
 Site Code :
 Start Date : 4/20/2021
 Page No : 1

Groups Printed- Trucks

Start Time	US 29 Southbound				US 29 Northbound				Int. Total
	Thru	Left	Peds	App. Total	Thru	Left	Peds	App. Total	
07:00 AM	10	0	0	10	17	0	0	17	27
07:15 AM	36	0	0	36	11	0	0	11	47
07:30 AM	26	0	0	26	14	0	0	14	40
07:45 AM	17	0	0	17	20	0	0	20	37
Total	89	0	0	89	62	0	0	62	151
08:00 AM	22	0	0	22	13	0	0	13	35
08:15 AM	29	0	0	29	26	1	0	27	56
08:30 AM	23	0	0	23	13	0	0	13	36
08:45 AM	24	0	0	24	22	0	0	22	46
Total	98	0	0	98	74	1	0	75	173
Grand Total	187	0	0	187	136	1	0	137	324
Apprch %	100	0	0		99.3	0.7	0		
Total %	57.7	0	0	57.7	42	0.3	0	42.3	

Peggy Malone & Associates
904-992-8072

File Name : 14_US 29 Median Cut North of Cyress Dr AM
 Site Code :
 Start Date : 4/20/2021
 Page No : 1

Groups Printed- Combined

Start Time	US 29 Southbound				US 29 Northbound				Int. Total
	Thru	Left	Peds	App. Total	Thru	Left	Peds	App. Total	
07:00 AM	421	0	0	421	181	4	0	185	606
07:15 AM	507	0	0	507	209	3	0	212	719
07:30 AM	556	0	0	556	195	2	0	197	753
07:45 AM	498	0	0	498	263	5	0	268	766
Total	1982	0	0	1982	848	14	0	862	2844
08:00 AM	415	0	0	415	255	5	0	260	675
08:15 AM	412	0	0	412	244	2	0	246	658
08:30 AM	351	0	0	351	218	4	0	222	573
08:45 AM	357	0	0	357	239	1	0	240	597
Total	1535	0	0	1535	956	12	0	968	2503
Grand Total	3517	0	0	3517	1804	26	0	1830	5347
Apprch %	100	0	0		98.6	1.4	0		
Total %	65.8	0	0	65.8	33.7	0.5	0	34.2	

Peggy Malone & Associates
904-992-8072

File Name : 14_US 29 Median Cut North of Cyress Dr PM
Site Code :
Start Date : 4/20/2021
Page No : 1

Groups Printed- Cars

Start Time	US 29 Southbound				US 29 Northbound				Int. Total
	Thru	Left	Peds	App. Total	Thru	Left	Peds	App. Total	
04:00 PM	327	0	0	327	339	2	0	341	668
04:15 PM	326	0	0	326	417	3	0	420	746
04:30 PM	364	0	0	364	453	5	0	458	822
04:45 PM	309	0	0	309	479	6	0	485	794
Total	1326	0	0	1326	1688	16	0	1704	3030
05:00 PM	256	1	0	257	458	1	0	459	716
05:15 PM	311	0	0	311	486	4	0	490	801
05:30 PM	303	0	0	303	507	12	0	519	822
05:45 PM	245	0	0	245	446	7	0	453	698
Total	1115	1	0	1116	1897	24	0	1921	3037
Grand Total	2441	1	0	2442	3585	40	0	3625	6067
Apprch %	100	0	0		98.9	1.1	0		
Total %	40.2	0	0	40.3	59.1	0.7	0	59.7	

Start Time	US 29 Southbound			US 29 Northbound			Int. Total
	Thru	Left	App. Total	Thru	Left	App. Total	
Peak Hour Analysis From 04:00 PM to 05:45 PM - Peak 1 of 1							
Peak Hour for Entire Intersection Begins at 04:30 PM							
04:30 PM	364	0	364	453	5	458	822
04:45 PM	309	0	309	479	6	485	794
05:00 PM	256	1	257	458	1	459	716
05:15 PM	311	0	311	486	4	490	801
Total Volume	1240	1	1241	1876	16	1892	3133
% App. Total	99.9	0.1		99.2	0.8		
PHF	.852	.250	.852	.965	.667	.965	.953

Peggy Malone & Associates
904-992-8072

File Name : 14_US 29 Median Cut North of Cyress Dr PM
 Site Code :
 Start Date : 4/20/2021
 Page No : 1

Groups Printed- Trucks

Start Time	US 29 Southbound				US 29 Northbound				Int. Total
	Thru	Left	Peds	App. Total	Thru	Left	Peds	App. Total	
04:00 PM	11	0	0	11	12	2	0	14	25
04:15 PM	14	0	0	14	19	1	0	20	34
04:30 PM	17	0	0	17	29	1	0	30	47
04:45 PM	10	0	0	10	8	0	0	8	18
Total	52	0	0	52	68	4	0	72	124
05:00 PM	10	0	0	10	11	0	0	11	21
05:15 PM	8	0	0	8	10	0	0	10	18
05:30 PM	11	0	0	11	9	1	0	10	21
05:45 PM	17	0	0	17	7	0	0	7	24
Total	46	0	0	46	37	1	0	38	84
Grand Total	98	0	0	98	105	5	0	110	208
Apprch %	100	0	0		95.5	4.5	0		
Total %	47.1	0	0	47.1	50.5	2.4	0	52.9	

Start Time	US 29 Southbound			US 29 Northbound			Int. Total
	Thru	Left	App. Total	Thru	Left	App. Total	
Peak Hour Analysis From 04:00 PM to 05:45 PM - Peak 1 of 1							
Peak Hour for Entire Intersection Begins at 04:00 PM							
04:00 PM	11	0	11	12	2	14	25
04:15 PM	14	0	14	19	1	20	34
04:30 PM	17	0	17	29	1	30	47
04:45 PM	10	0	10	8	0	8	18
Total Volume	52	0	52	68	4	72	124
% App. Total	100	0		94.4	5.6		
PHF	.765	.000	.765	.586	.500	.600	.660

Peggy Malone & Associates
904-992-8072

File Name : 14_US 29 Median Cut North of Cyress Dr PM
 Site Code :
 Start Date : 4/20/2021
 Page No : 1

Groups Printed- Combined

Start Time	US 29 Southbound				US 29 Northbound				Int. Total
	Thru	Left	Peds	App. Total	Thru	Left	Peds	App. Total	
04:00 PM	338	0	0	338	351	4	0	355	693
04:15 PM	340	0	0	340	436	4	0	440	780
04:30 PM	381	0	0	381	482	6	0	488	869
04:45 PM	319	0	0	319	487	6	0	493	812
Total	1378	0	0	1378	1756	20	0	1776	3154
05:00 PM	266	1	0	267	469	1	0	470	737
05:15 PM	319	0	0	319	496	4	0	500	819
05:30 PM	314	0	0	314	516	13	0	529	843
05:45 PM	262	0	0	262	453	7	0	460	722
Total	1161	1	0	1162	1934	25	0	1959	3121
Grand Total	2539	1	0	2540	3690	45	0	3735	6275
Apprch %	100	0	0		98.8	1.2	0		
Total %	40.5	0	0	40.5	58.8	0.7	0	59.5	

Start Time	US 29 Southbound			US 29 Northbound			Int. Total
	Thru	Left	App. Total	Thru	Left	App. Total	
Peak Hour Analysis From 04:00 PM to 05:45 PM - Peak 1 of 1							
Peak Hour for Entire Intersection Begins at 04:30 PM							
04:30 PM	381	0	381	482	6	488	869
04:45 PM	319	0	319	487	6	493	812
05:00 PM	266	1	267	469	1	470	737
05:15 PM	319	0	319	496	4	500	819
Total Volume	1285	1	1286	1934	17	1951	3237
% App. Total	99.9	0.1		99.1	0.9		
PHF	.843	.250	.844	.975	.708	.976	.931

Peggy Malone & Associates

(888) 247-8602

File Name : 10_US 29 & Northside Dr AM
 Site Code :
 Start Date : 4/13/2021
 Page No : 1

Groups Printed- Cars

Start Time	US 29 Southbound					Northside Dr Westbound					US 29 Northbound					Northside Dr Eastbound					Int. Total
	Right	Thru	Left	Peds	App. Total	Right	Thru	Left	Peds	App. Total	Right	Thru	Left	Peds	App. Total	Right	Thru	Left	Peds	App. Total	
07:00 AM	2	375	1	0	378	1	0	0	0	1	1	164	1	0	166	3	0	0	0	3	548
07:15 AM	2	513	3	0	518	0	0	0	0	0	1	189	0	0	190	0	0	0	0	0	708
07:30 AM	1	478	0	0	479	0	0	0	0	0	1	199	2	0	202	2	0	1	0	3	684
07:45 AM	1	429	1	0	431	0	0	0	0	0	0	275	1	0	276	2	0	0	0	2	709
Total	6	1795	5	0	1806	1	0	0	0	1	3	827	4	0	834	7	0	1	0	8	2649
08:00 AM	2	363	0	0	365	0	0	0	0	0	1	215	1	0	217	2	0	0	0	2	584
08:15 AM	1	402	1	0	404	0	0	0	0	0	0	215	1	0	216	2	0	0	0	2	622
08:30 AM	1	356	1	0	358	1	0	0	0	1	1	208	2	0	211	6	0	0	0	6	576
08:45 AM	2	357	0	0	359	0	0	0	0	0	0	235	1	0	236	2	0	0	0	2	597
Total	6	1478	2	0	1486	1	0	0	0	1	2	873	5	0	880	12	0	0	0	12	2379
Grand Total	12	3273	7	0	3292	2	0	0	0	2	5	1700	9	0	1714	19	0	1	0	20	5028
Apprch %	0.4	99.4	0.2	0		100	0	0	0		0.3	99.2	0.5	0		95	0	5	0		
Total %	0.2	65.1	0.1	0	65.5	0	0	0	0	0	0.1	33.8	0.2	0	34.1	0.4	0	0	0	0.4	

Start Time	US 29 Southbound				Northside Dr Westbound				US 29 Northbound				Northside Dr Eastbound				Int. Total
	Right	Thru	Left	App. Total	Right	Thru	Left	App. Total	Right	Thru	Left	App. Total	Right	Thru	Left	App. Total	
Peak Hour Analysis From 07:00 AM to 08:45 AM - Peak 1 of 1																	
Peak Hour for Entire Intersection Begins at 07:15 AM																	
07:15 AM	2	513	3	518	0	0	0	0	1	189	0	190	0	0	0	0	708
07:30 AM	1	478	0	479	0	0	0	0	1	199	2	202	2	0	1	3	684
07:45 AM	1	429	1	431	0	0	0	0	0	275	1	276	2	0	0	2	709
08:00 AM	2	363	0	365	0	0	0	0	1	215	1	217	2	0	0	2	584
Total Volume	6	1783	4	1793	0	0	0	0	3	878	4	885	6	0	1	7	2685
% App. Total	0.3	99.4	0.2		0	0	0		0.3	99.2	0.5		85.7	0	14.3		
PHF	.750	.869	.333	.865	.000	.000	.000	.000	.750	.798	.500	.802	.750	.000	.250	.583	.947

Peggy Malone & Associates

(888) 247-8602

File Name : 10_US 29 & Northside Dr AM
 Site Code :
 Start Date : 4/13/2021
 Page No : 1

Groups Printed- Trucks

Start Time	US 29 Southbound					Northside Dr Westbound					US 29 Northbound					Northside Dr Eastbound					Int. Total
	Right	Thru	Left	Peds	App. Total	Right	Thru	Left	Peds	App. Total	Right	Thru	Left	Peds	App. Total	Right	Thru	Left	Peds	App. Total	
07:00 AM	1	18	0	0	19	0	0	0	0	0	1	16	1	0	18	3	0	0	0	3	40
07:15 AM	1	31	4	0	36	0	0	0	0	0	0	18	0	0	18	0	0	0	0	0	54
07:30 AM	0	18	1	0	19	1	0	0	0	1	0	16	0	0	16	1	0	0	0	1	37
07:45 AM	2	14	2	0	18	0	0	0	0	0	0	12	0	0	12	1	0	0	0	1	31
Total	4	81	7	0	92	1	0	0	0	1	1	62	1	0	64	5	0	0	0	5	162
08:00 AM	0	16	2	0	18	0	0	0	0	0	0	13	0	0	13	2	0	0	0	2	33
08:15 AM	0	17	2	0	19	2	0	0	0	2	0	20	1	0	21	0	0	0	0	0	42
08:30 AM	0	23	1	0	24	0	0	0	0	0	1	19	0	0	20	1	0	0	0	1	45
08:45 AM	0	13	2	0	15	0	0	0	0	0	0	22	0	0	22	1	0	0	0	1	38
Total	0	69	7	0	76	2	0	0	0	2	1	74	1	0	76	4	0	0	0	4	158
Grand Total	4	150	14	0	168	3	0	0	0	3	2	136	2	0	140	9	0	0	0	9	320
Apprch %	2.4	89.3	8.3	0		100	0	0	0		1.4	97.1	1.4	0		100	0	0	0		
Total %	1.2	46.9	4.4	0	52.5	0.9	0	0	0	0.9	0.6	42.5	0.6	0	43.8	2.8	0	0	0	2.8	

Start Time	US 29 Southbound				Northside Dr Westbound				US 29 Northbound				Northside Dr Eastbound				Int. Total
	Right	Thru	Left	App. Total	Right	Thru	Left	App. Total	Right	Thru	Left	App. Total	Right	Thru	Left	App. Total	
Peak Hour Analysis From 07:00 AM to 08:45 AM - Peak 1 of 1																	
Peak Hour for Entire Intersection Begins at 07:00 AM																	
07:00 AM	1	18	0	19	0	0	0	0	1	16	1	18	3	0	0	3	40
07:15 AM	1	31	4	36	0	0	0	0	0	18	0	18	0	0	0	0	54
07:30 AM	0	18	1	19	1	0	0	1	0	16	0	16	1	0	0	1	37
07:45 AM	2	14	2	18	0	0	0	0	0	12	0	12	1	0	0	1	31
Total Volume	4	81	7	92	1	0	0	1	1	62	1	64	5	0	0	5	162
% App. Total	4.3	88	7.6		100	0	0		1.6	96.9	1.6		100	0	0		
PHF	.500	.653	.438	.639	.250	.000	.000	.250	.250	.861	.250	.889	.417	.000	.000	.417	.750

Peggy Malone & Associates

(888) 247-8602

File Name : 10_US 29 & Northside Dr AM
 Site Code :
 Start Date : 4/13/2021
 Page No : 1

Groups Printed- Combined

Start Time	US 29 Southbound					Northside Dr Westbound					US 29 Northbound					Northside Dr Eastbound					Int. Total
	Right	Thru	Left	Peds	App. Total	Right	Thru	Left	Peds	App. Total	Right	Thru	Left	Peds	App. Total	Right	Thru	Left	Peds	App. Total	
07:00 AM	3	393	1	0	397	1	0	0	0	1	2	180	2	0	184	6	0	0	0	6	588
07:15 AM	3	544	7	0	554	0	0	0	0	0	1	207	0	0	208	0	0	0	0	0	762
07:30 AM	1	496	1	0	498	1	0	0	0	1	1	215	2	0	218	3	0	1	0	4	721
07:45 AM	3	443	3	0	449	0	0	0	0	0	0	287	1	0	288	3	0	0	0	3	740
Total	10	1876	12	0	1898	2	0	0	0	2	4	889	5	0	898	12	0	1	0	13	2811
08:00 AM	2	379	2	0	383	0	0	0	0	0	1	228	1	0	230	4	0	0	0	4	617
08:15 AM	1	419	3	0	423	2	0	0	0	2	0	235	2	0	237	2	0	0	0	2	664
08:30 AM	1	379	2	0	382	1	0	0	0	1	2	227	2	0	231	7	0	0	0	7	621
08:45 AM	2	370	2	0	374	0	0	0	0	0	0	257	1	0	258	3	0	0	0	3	635
Total	6	1547	9	0	1562	3	0	0	0	3	3	947	6	0	956	16	0	0	0	16	2537
Grand Total	16	3423	21	0	3460	5	0	0	0	5	7	1836	11	0	1854	28	0	1	0	29	5348
Apprch %	0.5	98.9	0.6	0		100	0	0	0		0.4	99	0.6	0		96.6	0	3.4	0		
Total %	0.3	64	0.4	0	64.7	0.1	0	0	0	0.1	0.1	34.3	0.2	0	34.7	0.5	0	0	0	0.5	

Start Time	US 29 Southbound				Northside Dr Westbound				US 29 Northbound				Northside Dr Eastbound				Int. Total
	Right	Thru	Left	App. Total	Right	Thru	Left	App. Total	Right	Thru	Left	App. Total	Right	Thru	Left	App. Total	
Peak Hour Analysis From 07:00 AM to 08:45 AM - Peak 1 of 1																	
Peak Hour for Entire Intersection Begins at 07:15 AM																	
07:15 AM	3	544	7	554	0	0	0	0	1	207	0	208	0	0	0	0	762
07:30 AM	1	496	1	498	1	0	0	1	1	215	2	218	3	0	1	4	721
07:45 AM	3	443	3	449	0	0	0	0	0	287	1	288	3	0	0	3	740
08:00 AM	2	379	2	383	0	0	0	0	1	228	1	230	4	0	0	4	617
Total Volume	9	1862	13	1884	1	0	0	1	3	937	4	944	10	0	1	11	2840
% App. Total	0.5	98.8	0.7		100	0	0		0.3	99.3	0.4		90.9	0	9.1		
PHF	.750	.856	.464	.850	.250	.000	.000	.250	.750	.816	.500	.819	.625	.000	.250	.688	.932

Peggy Malone & Associates

(888) 247-8602

File Name : 10_US 29 & Northside Dr PM
 Site Code :
 Start Date : 4/13/2021
 Page No : 1

Groups Printed- Cars

Start Time	US 29 Southbound					Northside Dr Westbound					US 29 Northbound					Northside Dr Eastbound					Int. Total
	Right	Thru	Left	Peds	App. Total	Right	Thru	Left	Peds	App. Total	Right	Thru	Left	Peds	App. Total	Right	Thru	Left	Peds	App. Total	
04:00 PM	0	316	2	0	318	1	0	0	0	1	0	370	1	0	371	0	0	0	0	0	690
04:15 PM	1	292	4	0	297	0	0	0	0	0	0	380	2	0	382	4	0	0	0	4	683
04:30 PM	0	320	6	0	326	2	0	0	0	2	2	409	1	0	412	1	0	0	0	1	741
04:45 PM	1	288	3	0	292	1	0	0	0	1	0	444	1	0	445	5	0	0	0	5	743
Total	2	1216	15	0	1233	4	0	0	0	4	2	1603	5	0	1610	10	0	0	0	10	2857
05:00 PM	0	303	7	0	310	0	0	0	0	0	0	480	1	0	481	6	0	0	0	6	797
05:15 PM	0	278	1	0	279	3	0	0	0	3	0	505	2	0	507	5	0	0	0	5	794
05:30 PM	0	266	2	0	268	9	0	0	0	9	0	449	1	0	450	1	0	0	0	1	728
05:45 PM	0	263	2	0	265	3	0	0	0	3	0	393	0	0	393	1	0	0	0	1	662
Total	0	1110	12	0	1122	15	0	0	0	15	0	1827	4	0	1831	13	0	0	0	13	2981
Grand Total	2	2326	27	0	2355	19	0	0	0	19	2	3430	9	0	3441	23	0	0	0	23	5838
Apprch %	0.1	98.8	1.1	0		100	0	0	0		0.1	99.7	0.3	0		100	0	0	0		
Total %	0	39.8	0.5	0	40.3	0.3	0	0	0	0.3	0	58.8	0.2	0	58.9	0.4	0	0	0	0.4	

Start Time	US 29 Southbound				Northside Dr Westbound				US 29 Northbound				Northside Dr Eastbound				Int. Total
	Right	Thru	Left	App. Total	Right	Thru	Left	App. Total	Right	Thru	Left	App. Total	Right	Thru	Left	App. Total	
Peak Hour Analysis From 04:00 PM to 05:45 PM - Peak 1 of 1																	
Peak Hour for Entire Intersection Begins at 04:30 PM																	
04:30 PM	0	320	6	326	2	0	0	2	2	409	1	412	1	0	0	1	741
04:45 PM	1	288	3	292	1	0	0	1	0	444	1	445	5	0	0	5	743
05:00 PM	0	303	7	310	0	0	0	0	0	480	1	481	6	0	0	6	797
05:15 PM	0	278	1	279	3	0	0	3	0	505	2	507	5	0	0	5	794
Total Volume	1	1189	17	1207	6	0	0	6	2	1838	5	1845	17	0	0	17	3075
% App. Total	0.1	98.5	1.4		100	0	0		0.1	99.6	0.3		100	0	0		
PHF	.250	.929	.607	.926	.500	.000	.000	.500	.250	.910	.625	.910	.708	.000	.000	.708	.965

Peggy Malone & Associates

(888) 247-8602

File Name : 10_US 29 & Northside Dr PM
 Site Code :
 Start Date : 4/13/2021
 Page No : 1

Groups Printed- Trucks

Start Time	US 29 Southbound					Northside Dr Westbound					US 29 Northbound					Northside Dr Eastbound					Int. Total
	Right	Thru	Left	Peds	App. Total	Right	Thru	Left	Peds	App. Total	Right	Thru	Left	Peds	App. Total	Right	Thru	Left	Peds	App. Total	
04:00 PM	0	15	0	0	15	2	0	0	0	2	0	12	1	0	13	1	0	0	0	1	31
04:15 PM	0	12	0	0	12	0	0	0	0	0	0	15	0	0	15	0	0	0	0	0	27
04:30 PM	3	24	1	0	28	1	0	0	0	1	0	18	0	0	18	0	0	0	0	0	47
04:45 PM	0	11	0	0	11	0	0	0	0	0	0	17	0	0	17	0	0	0	0	0	28
Total	3	62	1	0	66	3	0	0	0	3	0	62	1	0	63	1	0	0	0	1	133
05:00 PM	0	11	0	0	11	0	0	0	0	0	0	10	0	0	10	0	0	0	0	0	21
05:15 PM	0	5	0	0	5	0	0	0	0	0	0	9	0	0	9	0	0	0	0	0	14
05:30 PM	0	4	0	0	4	0	0	0	0	0	0	4	0	0	4	0	0	0	0	0	8
05:45 PM	0	6	0	0	6	1	0	0	0	1	1	4	0	0	5	0	0	0	0	0	12
Total	0	26	0	0	26	1	0	0	0	1	1	27	0	0	28	0	0	0	0	0	55
Grand Total	3	88	1	0	92	4	0	0	0	4	1	89	1	0	91	1	0	0	0	1	188
Apprch %	3.3	95.7	1.1	0		100	0	0	0		1.1	97.8	1.1	0		100	0	0	0		
Total %	1.6	46.8	0.5	0	48.9	2.1	0	0	0	2.1	0.5	47.3	0.5	0	48.4	0.5	0	0	0	0.5	

Start Time	US 29 Southbound				Northside Dr Westbound				US 29 Northbound				Northside Dr Eastbound				Int. Total
	Right	Thru	Left	App. Total	Right	Thru	Left	App. Total	Right	Thru	Left	App. Total	Right	Thru	Left	App. Total	
Peak Hour Analysis From 04:00 PM to 05:45 PM - Peak 1 of 1																	
Peak Hour for Entire Intersection Begins at 04:00 PM																	
04:00 PM	0	15	0	15	2	0	0	2	0	12	1	13	1	0	0	1	31
04:15 PM	0	12	0	12	0	0	0	0	0	15	0	15	0	0	0	0	27
04:30 PM	3	24	1	28	1	0	0	1	0	18	0	18	0	0	0	0	47
04:45 PM	0	11	0	11	0	0	0	0	0	17	0	17	0	0	0	0	28
Total Volume	3	62	1	66	3	0	0	3	0	62	1	63	1	0	0	1	133
% App. Total	4.5	93.9	1.5		100	0	0		0	98.4	1.6		100	0	0		
PHF	.250	.646	.250	.589	.375	.000	.000	.375	.000	.861	.250	.875	.250	.000	.000	.250	.707

Peggy Malone & Associates

(888) 247-8602

File Name : 10_US 29 & Northside Dr PM
 Site Code :
 Start Date : 4/13/2021
 Page No : 1

Groups Printed- Combined

Start Time	US 29 Southbound					Northside Dr Westbound					US 29 Northbound					Northside Dr Eastbound					Int. Total
	Right	Thru	Left	Peds	App. Total	Right	Thru	Left	Peds	App. Total	Right	Thru	Left	Peds	App. Total	Right	Thru	Left	Peds	App. Total	
04:00 PM	0	331	2	0	333	3	0	0	0	3	0	382	2	0	384	1	0	0	0	1	721
04:15 PM	1	304	4	0	309	0	0	0	0	0	0	395	2	0	397	4	0	0	0	4	710
04:30 PM	3	344	7	0	354	3	0	0	0	3	2	427	1	0	430	1	0	0	0	1	788
04:45 PM	1	299	3	0	303	1	0	0	0	1	0	461	1	0	462	5	0	0	0	5	771
Total	5	1278	16	0	1299	7	0	0	0	7	2	1665	6	0	1673	11	0	0	0	11	2990
05:00 PM	0	314	7	0	321	0	0	0	0	0	0	490	1	0	491	6	0	0	0	6	818
05:15 PM	0	283	1	0	284	3	0	0	0	3	0	514	2	0	516	5	0	0	0	5	808
05:30 PM	0	270	2	0	272	9	0	0	0	9	0	453	1	0	454	1	0	0	0	1	736
05:45 PM	0	269	2	0	271	4	0	0	0	4	1	397	0	0	398	1	0	0	0	1	674
Total	0	1136	12	0	1148	16	0	0	0	16	1	1854	4	0	1859	13	0	0	0	13	3036
Grand Total	5	2414	28	0	2447	23	0	0	0	23	3	3519	10	0	3532	24	0	0	0	24	6026
Apprch %	0.2	98.7	1.1	0		100	0	0	0		0.1	99.6	0.3	0		100	0	0	0		
Total %	0.1	40.1	0.5	0	40.6	0.4	0	0	0	0.4	0	58.4	0.2	0	58.6	0.4	0	0	0	0.4	

Start Time	US 29 Southbound				Northside Dr Westbound				US 29 Northbound				Northside Dr Eastbound				Int. Total
	Right	Thru	Left	App. Total	Right	Thru	Left	App. Total	Right	Thru	Left	App. Total	Right	Thru	Left	App. Total	
Peak Hour Analysis From 04:00 PM to 05:45 PM - Peak 1 of 1																	
Peak Hour for Entire Intersection Begins at 04:30 PM																	
04:30 PM	3	344	7	354	3	0	0	3	2	427	1	430	1	0	0	1	788
04:45 PM	1	299	3	303	1	0	0	1	0	461	1	462	5	0	0	5	771
05:00 PM	0	314	7	321	0	0	0	0	0	490	1	491	6	0	0	6	818
05:15 PM	0	283	1	284	3	0	0	3	0	514	2	516	5	0	0	5	808
Total Volume	4	1240	18	1262	7	0	0	7	2	1892	5	1899	17	0	0	17	3185
% App. Total	0.3	98.3	1.4		100	0	0		0.1	99.6	0.3		100	0	0		
PHF	.333	.901	.643	.891	.583	.000	.000	.583	.250	.920	.625	.920	.708	.000	.000	.708	.973

Peggy Malone & Associates

(888) 247-8602

File Name : 11_US 29 & Airport Acres Rd (N) AM
 Site Code :
 Start Date : 4/13/2021
 Page No : 1

Groups Printed- Cars

Start Time	US 29 Southbound					US 29 Northbound				Airport Acres Rd Eastbound				Int. Total
	Right	Thru	Left	Peds	App. Total	Thru	Left	Peds	App. Total	Right	Left	Peds	App. Total	
07:00 AM	1	360	1	0	362	169	0	0	169	3	0	0	3	534
07:15 AM	0	517	1	0	518	168	0	0	168	1	0	0	1	687
07:30 AM	0	522	0	0	522	199	0	0	199	1	0	0	1	722
07:45 AM	0	411	0	0	411	271	0	0	271	0	0	0	0	682
Total	1	1810	2	0	1813	807	0	0	807	5	0	0	5	2625
08:00 AM	0	362	0	0	362	220	1	0	221	1	0	0	1	584
08:15 AM	0	402	0	0	402	230	1	0	231	3	0	0	3	636
08:30 AM	0	374	2	0	376	201	0	0	201	1	0	0	1	578
08:45 AM	1	367	0	0	368	229	1	0	230	1	0	0	1	599
Total	1	1505	2	0	1508	880	3	0	883	6	0	0	6	2397
Grand Total	2	3315	4	0	3321	1687	3	0	1690	11	0	0	11	5022
Apprch %	0.1	99.8	0.1	0		99.8	0.2	0		100	0	0		
Total %	0	66	0.1	0	66.1	33.6	0.1	0	33.7	0.2	0	0	0.2	

Start Time	US 29 Southbound				US 29 Northbound				Airport Acres Rd Eastbound				Int. Total
	Right	Thru	Left	App. Total	Thru	Left	App. Total	Right	Left	App. Total			
Peak Hour Analysis From 07:00 AM to 08:45 AM - Peak 1 of 1													
Peak Hour for Entire Intersection Begins at 07:15 AM													
07:15 AM	0	517	1	518	168	0	168	1	0	1	687		
07:30 AM	0	522	0	522	199	0	199	1	0	1	722		
07:45 AM	0	411	0	411	271	0	271	0	0	0	682		
08:00 AM	0	362	0	362	220	1	221	1	0	1	584		
Total Volume	0	1812	1	1813	858	1	859	3	0	3	2675		
% App. Total	0	99.9	0.1		99.9	0.1		100	0				
PHF	.000	.868	.250	.868	.792	.250	.792	.750	.000	.750	.926		

Peggy Malone & Associates

(888) 247-8602

File Name : 11_US 29 & Airport Acres Rd (N) AM
 Site Code :
 Start Date : 4/13/2021
 Page No : 1

Groups Printed- Combined

Start Time	US 29 Southbound					US 29 Northbound				Airport Acres Rd Eastbound				Int. Total
	Right	Thru	Left	Peds	App. Total	Thru	Left	Peds	App. Total	Right	Left	Peds	App. Total	
07:00 AM	1	378	1	0	380	186	1	0	187	3	0	0	3	570
07:15 AM	1	547	1	0	549	185	0	0	185	1	0	0	1	735
07:30 AM	0	541	0	0	541	215	0	0	215	1	0	0	1	757
07:45 AM	0	425	0	0	425	282	0	0	282	0	0	0	0	707
Total	2	1891	2	0	1895	868	1	0	869	5	0	0	5	2769
08:00 AM	0	380	0	0	380	236	1	0	237	1	0	0	1	618
08:15 AM	0	419	0	0	419	249	1	0	250	3	0	0	3	672
08:30 AM	0	398	2	0	400	220	0	0	220	1	0	0	1	621
08:45 AM	1	381	1	0	383	250	1	0	251	1	0	0	1	635
Total	1	1578	3	0	1582	955	3	0	958	6	0	0	6	2546
Grand Total	3	3469	5	0	3477	1823	4	0	1827	11	0	0	11	5315
Apprch %	0.1	99.8	0.1	0		99.8	0.2	0		100	0	0		
Total %	0.1	65.3	0.1	0	65.4	34.3	0.1	0	34.4	0.2	0	0	0.2	

Start Time	US 29 Southbound				US 29 Northbound			Airport Acres Rd Eastbound			Int. Total
	Right	Thru	Left	App. Total	Thru	Left	App. Total	Right	Left	App. Total	
Peak Hour Analysis From 07:00 AM to 08:45 AM - Peak 1 of 1											
Peak Hour for Entire Intersection Begins at 07:15 AM											
07:15 AM	1	547	1	549	185	0	185	1	0	1	735
07:30 AM	0	541	0	541	215	0	215	1	0	1	757
07:45 AM	0	425	0	425	282	0	282	0	0	0	707
08:00 AM	0	380	0	380	236	1	237	1	0	1	618
Total Volume	1	1893	1	1895	918	1	919	3	0	3	2817
% App. Total	0.1	99.9	0.1		99.9	0.1		100	0		
PHF	.250	.865	.250	.863	.814	.250	.815	.750	.000	.750	.930

Peggy Malone & Associates

(888) 247-8602

File Name : 11_US 29 & Airport Acres Rd (N) PM
 Site Code :
 Start Date : 4/13/2021
 Page No : 1

Groups Printed- Cars

Start Time	US 29 Southbound					US 29 Northbound				Airport Acres Rd Eastbound				Int. Total
	Right	Thru	Left	Peds	App. Total	Thru	Left	Peds	App. Total	Right	Left	Peds	App. Total	
04:00 PM	0	317	0	0	317	362	2	0	364	1	0	0	1	682
04:15 PM	1	283	0	0	284	384	0	0	384	3	0	0	3	671
04:30 PM	0	323	0	0	323	412	1	0	413	0	0	0	0	736
04:45 PM	1	288	2	0	291	458	3	0	461	0	0	0	0	752
Total	2	1211	2	0	1215	1616	6	0	1622	4	0	0	4	2841
05:00 PM	1	333	1	0	335	461	0	0	461	1	0	0	1	797
05:15 PM	1	284	4	0	289	491	3	0	494	3	0	0	3	786
05:30 PM	0	271	0	0	271	427	1	0	428	2	0	0	2	701
05:45 PM	0	248	2	0	250	371	1	0	372	1	0	0	1	623
Total	2	1136	7	0	1145	1750	5	0	1755	7	0	0	7	2907
Grand Total	4	2347	9	0	2360	3366	11	0	3377	11	0	0	11	5748
Apprch %	0.2	99.4	0.4	0	41.1	99.7	0.3	0	58.8	100	0	0	0.2	
Total %	0.1	40.8	0.2	0	41.1	58.6	0.2	0	58.8	0.2	0	0	0.2	

Start Time	US 29 Southbound				US 29 Northbound				Airport Acres Rd Eastbound				Int. Total
	Right	Thru	Left	App. Total	Thru	Left	App. Total	Right	Left	App. Total			
Peak Hour Analysis From 04:00 PM to 05:45 PM - Peak 1 of 1													
Peak Hour for Entire Intersection Begins at 04:30 PM													
04:30 PM	0	323	0	323	412	1	413	0	0	0	0	0	736
04:45 PM	1	288	2	291	458	3	461	0	0	0	0	0	752
05:00 PM	1	333	1	335	461	0	461	1	0	1	0	1	797
05:15 PM	1	284	4	289	491	3	494	3	0	3	0	3	786
Total Volume	3	1228	7	1238	1822	7	1829	4	0	4	0	4	3071
% App. Total	0.2	99.2	0.6	41.1	99.6	0.4	58.8	100	0	0.2	0	0.2	
PHF	.750	.922	.438	.924	.928	.583	.926	.333	.000	.333	.000	.333	.963

Peggy Malone & Associates
(888) 247-8602

File Name : 11_US 29 & Airport Acres Rd (N) PM
Site Code :
Start Date : 4/13/2021
Page No : 1

Groups Printed- Trucks

Start Time	US 29 Southbound					US 29 Northbound				Airport Acres Rd Eastbound				Int. Total
	Right	Thru	Left	Peds	App. Total	Thru	Left	Peds	App. Total	Right	Left	Peds	App. Total	
04:00 PM	0	16	1	0	17	13	0	0	13	0	0	0	0	30
04:15 PM	0	12	0	0	12	16	0	0	16	1	0	0	1	29
04:30 PM	1	23	0	0	24	18	0	0	18	0	0	0	0	42
04:45 PM	0	12	0	0	12	17	0	0	17	0	0	0	0	29
Total	1	63	1	0	65	64	0	0	64	1	0	0	1	130
05:00 PM	0	11	0	0	11	10	0	0	10	0	0	0	0	21
05:15 PM	0	5	0	0	5	8	0	0	8	0	0	0	0	13
05:30 PM	1	3	0	0	4	5	0	0	5	0	0	0	0	9
05:45 PM	0	7	0	0	7	5	0	0	5	0	0	0	0	12
Total	1	26	0	0	27	28	0	0	28	0	0	0	0	55
Grand Total	2	89	1	0	92	92	0	0	92	1	0	0	1	185
Apprch %	2.2	96.7	1.1	0		100	0	0		100	0	0		
Total %	1.1	48.1	0.5	0	49.7	49.7	0	0	49.7	0.5	0	0	0.5	

Start Time	US 29 Southbound				US 29 Northbound				Airport Acres Rd Eastbound				Int. Total
	Right	Thru	Left	App. Total	Thru	Left	App. Total	Right	Left	App. Total			
Peak Hour Analysis From 04:00 PM to 05:45 PM - Peak 1 of 1													
Peak Hour for Entire Intersection Begins at 04:00 PM													
04:00 PM	0	16	1	17	13	0	13	0	0	0	0	0	30
04:15 PM	0	12	0	12	16	0	16	1	0	1	0	1	29
04:30 PM	1	23	0	24	18	0	18	0	0	0	0	0	42
04:45 PM	0	12	0	12	17	0	17	0	0	0	0	0	29
Total Volume	1	63	1	65	64	0	64	1	0	1	0	1	130
% App. Total	1.5	96.9	1.5		100	0		100	0		0		
PHF	.250	.685	.250	.677	.889	.000	.889	.250	.000	.250		.774	

Peggy Malone & Associates

(888) 247-8602

File Name : 11_US 29 & Airport Acres Rd (N) PM
 Site Code :
 Start Date : 4/13/2021
 Page No : 1

Groups Printed- Combined

Start Time	US 29 Southbound					US 29 Northbound				Airport Acres Rd Eastbound				Int. Total
	Right	Thru	Left	Peds	App. Total	Thru	Left	Peds	App. Total	Right	Left	Peds	App. Total	
04:00 PM	0	333	1	0	334	375	2	0	377	1	0	0	1	712
04:15 PM	1	295	0	0	296	400	0	0	400	4	0	0	4	700
04:30 PM	1	346	0	0	347	430	1	0	431	0	0	0	0	778
04:45 PM	1	300	2	0	303	475	3	0	478	0	0	0	0	781
Total	3	1274	3	0	1280	1680	6	0	1686	5	0	0	5	2971
05:00 PM	1	344	1	0	346	471	0	0	471	1	0	0	1	818
05:15 PM	1	289	4	0	294	499	3	0	502	3	0	0	3	799
05:30 PM	1	274	0	0	275	432	1	0	433	2	0	0	2	710
05:45 PM	0	255	2	0	257	376	1	0	377	1	0	0	1	635
Total	3	1162	7	0	1172	1778	5	0	1783	7	0	0	7	2962
Grand Total	6	2436	10	0	2452	3458	11	0	3469	12	0	0	12	5933
Apprch %	0.2	99.3	0.4	0		99.7	0.3	0		100	0	0		
Total %	0.1	41.1	0.2	0	41.3	58.3	0.2	0	58.5	0.2	0	0	0.2	

Start Time	US 29 Southbound				US 29 Northbound				Airport Acres Rd Eastbound				Int. Total	
	Right	Thru	Left	App. Total	Thru	Left	App. Total	Right	Left	App. Total				
Peak Hour Analysis From 04:00 PM to 05:45 PM - Peak 1 of 1														
Peak Hour for Entire Intersection Begins at 04:30 PM														
04:30 PM	1	346	0	347	430	1	431	0	0	0	778			
04:45 PM	1	300	2	303	475	3	478	0	0	0	781			
05:00 PM	1	344	1	346	471	0	471	1	0	1	818			
05:15 PM	1	289	4	294	499	3	502	3	0	3	799			
Total Volume	4	1279	7	1290	1875	7	1882	4	0	4	3176			
% App. Total	0.3	99.1	0.5		99.6	0.4		100	0					
PHF	1.00	.924	.438	.929	.939	.583	.937	.333	.000	.333	.971			

Peggy Malone & Associates

(888) 247-8602

File Name : 12_US 29 & Airport Acres Rd (S) AM
 Site Code :
 Start Date : 4/13/2021
 Page No : 1

Groups Printed- Cars

Start Time	US 29 Southbound					US 29 Northbound				Airport Acres Rd Eastbound				Int. Total
	Right	Thru	Left	Peds	App. Total	Thru	Left	Peds	App. Total	Right	Left	Peds	App. Total	
07:00 AM	0	362	0	0	362	167	0	0	167	2	0	0	2	531
07:15 AM	0	497	0	0	497	169	0	0	169	1	0	0	1	667
07:30 AM	0	533	0	0	533	184	0	0	184	0	1	0	1	718
07:45 AM	0	418	0	0	418	265	9	0	274	0	0	0	0	692
Total	0	1810	0	0	1810	785	9	0	794	3	1	0	4	2608
08:00 AM	1	355	0	0	356	213	6	0	219	3	1	0	4	579
08:15 AM	1	404	1	0	406	229	3	0	232	2	1	0	3	641
08:30 AM	1	365	0	0	366	203	0	0	203	2	0	0	2	571
08:45 AM	0	360	0	0	360	219	8	0	227	1	1	0	2	589
Total	3	1484	1	0	1488	864	17	0	881	8	3	0	11	2380
Grand Total	3	3294	1	0	3298	1649	26	0	1675	11	4	0	15	4988
Apprch %	0.1	99.9	0	0		98.4	1.6	0		73.3	26.7	0		
Total %	0.1	66	0	0	66.1	33.1	0.5	0	33.6	0.2	0.1	0	0.3	

Start Time	US 29 Southbound				US 29 Northbound				Airport Acres Rd Eastbound				Int. Total
	Right	Thru	Left	App. Total	Thru	Left	App. Total	Right	Left	App. Total			
Peak Hour Analysis From 07:00 AM to 08:45 AM - Peak 1 of 1													
Peak Hour for Entire Intersection Begins at 07:15 AM													
07:15 AM	0	497	0	497	169	0	169	1	0	1	667		
07:30 AM	0	533	0	533	184	0	184	0	1	1	718		
07:45 AM	0	418	0	418	265	9	274	0	0	0	692		
08:00 AM	1	355	0	356	213	6	219	3	1	4	579		
Total Volume	1	1803	0	1804	831	15	846	4	2	6	2656		
% App. Total	0.1	99.9	0		98.2	1.8		66.7	33.3				
PHF	.250	.846	.000	.846	.784	.417	.772	.333	.500	.375	.925		

Peggy Malone & Associates

(888) 247-8602

File Name : 12_US 29 & Airport Acres Rd (S) AM
 Site Code :
 Start Date : 4/13/2021
 Page No : 1

Groups Printed- Combined

Start Time	US 29 Southbound					US 29 Northbound				Airport Acres Rd Eastbound				Int. Total
	Right	Thru	Left	Peds	App. Total	Thru	Left	Peds	App. Total	Right	Left	Peds	App. Total	
07:00 AM	0	379	0	0	379	184	0	0	184	2	0	0	2	565
07:15 AM	0	527	0	0	527	186	0	0	186	1	0	0	1	714
07:30 AM	0	554	0	0	554	200	0	0	200	1	1	0	2	756
07:45 AM	0	434	0	0	434	276	9	0	285	0	0	0	0	719
Total	0	1894	0	0	1894	846	9	0	855	4	1	0	5	2754
08:00 AM	1	374	0	0	375	226	6	0	232	3	1	0	4	611
08:15 AM	1	419	1	0	421	249	3	0	252	2	1	0	3	676
08:30 AM	1	388	0	0	389	222	0	0	222	2	0	0	2	613
08:45 AM	0	376	0	0	376	241	8	0	249	1	1	0	2	627
Total	3	1557	1	0	1561	938	17	0	955	8	3	0	11	2527
Grand Total	3	3451	1	0	3455	1784	26	0	1810	12	4	0	16	5281
Apprch %	0.1	99.9	0	0		98.6	1.4	0		75	25	0		
Total %	0.1	65.3	0	0	65.4	33.8	0.5	0	34.3	0.2	0.1	0	0.3	

Start Time	US 29 Southbound				US 29 Northbound			Airport Acres Rd Eastbound			Int. Total
	Right	Thru	Left	App. Total	Thru	Left	App. Total	Right	Left	App. Total	
Peak Hour Analysis From 07:00 AM to 08:45 AM - Peak 1 of 1											
Peak Hour for Entire Intersection Begins at 07:15 AM											
07:15 AM	0	527	0	527	186	0	186	1	0	1	714
07:30 AM	0	554	0	554	200	0	200	1	1	2	756
07:45 AM	0	434	0	434	276	9	285	0	0	0	719
08:00 AM	1	374	0	375	226	6	232	3	1	4	611
Total Volume	1	1889	0	1890	888	15	903	5	2	7	2800
% App. Total	0.1	99.9	0		98.3	1.7		71.4	28.6		
PHF	.250	.852	.000	.853	.804	.417	.792	.417	.500	.438	.926

Peggy Malone & Associates
(888) 247-8602

File Name : 12_US 29 & Airport Acres Rd (S) PM
Site Code :
Start Date : 4/13/2021
Page No : 1

Groups Printed- Cars

Start Time	US 29 Southbound					US 29 Northbound				Airport Acres Rd Eastbound				Int. Total
	Right	Thru	Left	Peds	App. Total	Thru	Left	Peds	App. Total	Right	Left	Peds	App. Total	
04:00 PM	0	322	0	0	322	370	4	0	374	1	0	0	1	697
04:15 PM	0	293	0	0	293	379	6	0	385	4	0	0	4	682
04:30 PM	0	317	0	0	317	423	3	0	426	1	0	0	1	744
04:45 PM	0	295	0	0	295	451	2	0	453	3	0	0	3	751
Total	0	1227	0	0	1227	1623	15	0	1638	9	0	0	9	2874
05:00 PM	0	328	0	0	328	472	7	0	479	1	1	0	2	809
05:15 PM	0	296	1	0	297	494	7	0	501	1	0	0	1	799
05:30 PM	0	266	0	0	266	435	2	0	437	1	1	0	2	705
05:45 PM	0	252	0	0	252	362	2	0	364	0	0	0	0	616
Total	0	1142	1	0	1143	1763	18	0	1781	3	2	0	5	2929
Grand Total	0	2369	1	0	2370	3386	33	0	3419	12	2	0	14	5803
Apprch %	0	100	0	0		99	1	0		85.7	14.3	0		
Total %	0	40.8	0	0	40.8	58.3	0.6	0	58.9	0.2	0	0	0.2	

Start Time	US 29 Southbound				US 29 Northbound			Airport Acres Rd Eastbound			Int. Total
	Right	Thru	Left	App. Total	Thru	Left	App. Total	Right	Left	App. Total	
Peak Hour Analysis From 04:00 PM to 05:45 PM - Peak 1 of 1											
Peak Hour for Entire Intersection Begins at 04:30 PM											
04:30 PM	0	317	0	317	423	3	426	1	0	1	744
04:45 PM	0	295	0	295	451	2	453	3	0	3	751
05:00 PM	0	328	0	328	472	7	479	1	1	2	809
05:15 PM	0	296	1	297	494	7	501	1	0	1	799
Total Volume	0	1236	1	1237	1840	19	1859	6	1	7	3103
% App. Total	0	99.9	0.1		99	1		85.7	14.3		
PHF	.000	.942	.250	.943	.931	.679	.928	.500	.250	.583	.959

Peggy Malone & Associates
(888) 247-8602

File Name : 12_US 29 & Airport Acres Rd (S) PM
Site Code :
Start Date : 4/13/2021
Page No : 1

Groups Printed- Trucks

Start Time	US 29 Southbound					US 29 Northbound				Airport Acres Rd Eastbound				Int. Total
	Right	Thru	Left	Peds	App. Total	Thru	Left	Peds	App. Total	Right	Left	Peds	App. Total	
04:00 PM	0	15	0	0	15	12	0	0	12	0	0	0	0	27
04:15 PM	0	14	0	0	14	16	0	0	16	0	0	0	0	30
04:30 PM	0	23	0	0	23	17	0	0	17	1	0	0	1	41
04:45 PM	0	12	0	0	12	17	0	0	17	0	0	0	0	29
Total	0	64	0	0	64	62	0	0	62	1	0	0	1	127
05:00 PM	0	10	0	0	10	11	0	0	11	0	0	0	0	21
05:15 PM	0	5	0	0	5	8	0	0	8	0	0	0	0	13
05:30 PM	0	3	0	0	3	5	0	0	5	0	0	0	0	8
05:45 PM	0	7	0	0	7	6	0	0	6	1	0	0	1	14
Total	0	25	0	0	25	30	0	0	30	1	0	0	1	56
Grand Total	0	89	0	0	89	92	0	0	92	2	0	0	2	183
Apprch %	0	100	0	0		100	0	0		100	0	0		
Total %	0	48.6	0	0	48.6	50.3	0	0	50.3	1.1	0	0	1.1	

Start Time	US 29 Southbound				US 29 Northbound			Airport Acres Rd Eastbound			Int. Total
	Right	Thru	Left	App. Total	Thru	Left	App. Total	Right	Left	App. Total	
Peak Hour Analysis From 04:00 PM to 05:45 PM - Peak 1 of 1											
Peak Hour for Entire Intersection Begins at 04:00 PM											
04:00 PM	0	15	0	15	12	0	12	0	0	0	27
04:15 PM	0	14	0	14	16	0	16	0	0	0	30
04:30 PM	0	23	0	23	17	0	17	1	0	1	41
04:45 PM	0	12	0	12	17	0	17	0	0	0	29
Total Volume	0	64	0	64	62	0	62	1	0	1	127
% App. Total	0	100	0		100	0		100	0		
PHF	.000	.696	.000	.696	.912	.000	.912	.250	.000	.250	.774

Peggy Malone & Associates

(888) 247-8602

File Name : 12_US 29 & Airport Acres Rd (S) PM
 Site Code :
 Start Date : 4/13/2021
 Page No : 1

Groups Printed- Combined

Start Time	US 29 Southbound					US 29 Northbound				Airport Acres Rd Eastbound				Int. Total
	Right	Thru	Left	Peds	App. Total	Thru	Left	Peds	App. Total	Right	Left	Peds	App. Total	
04:00 PM	0	337	0	0	337	382	4	0	386	1	0	0	1	724
04:15 PM	0	307	0	0	307	395	6	0	401	4	0	0	4	712
04:30 PM	0	340	0	0	340	440	3	0	443	2	0	0	2	785
04:45 PM	0	307	0	0	307	468	2	0	470	3	0	0	3	780
Total	0	1291	0	0	1291	1685	15	0	1700	10	0	0	10	3001
05:00 PM	0	338	0	0	338	483	7	0	490	1	1	0	2	830
05:15 PM	0	301	1	0	302	502	7	0	509	1	0	0	1	812
05:30 PM	0	269	0	0	269	440	2	0	442	1	1	0	2	713
05:45 PM	0	259	0	0	259	368	2	0	370	1	0	0	1	630
Total	0	1167	1	0	1168	1793	18	0	1811	4	2	0	6	2985
Grand Total	0	2458	1	0	2459	3478	33	0	3511	14	2	0	16	5986
Apprch %	0	100	0	0		99.1	0.9	0		87.5	12.5	0		
Total %	0	41.1	0	0	41.1	58.1	0.6	0	58.7	0.2	0	0	0.3	

Start Time	US 29 Southbound				US 29 Northbound				Airport Acres Rd Eastbound				Int. Total
	Right	Thru	Left	App. Total	Thru	Left	App. Total	Right	Left	App. Total			
Peak Hour Analysis From 04:00 PM to 05:45 PM - Peak 1 of 1													
Peak Hour for Entire Intersection Begins at 04:30 PM													
04:30 PM	0	340	0	340	440	3	443	2	0	2			785
04:45 PM	0	307	0	307	468	2	470	3	0	3			780
05:00 PM	0	338	0	338	483	7	490	1	1	2			830
05:15 PM	0	301	1	302	502	7	509	1	0	1			812
Total Volume	0	1286	1	1287	1893	19	1912	7	1	8			3207
% App. Total	0	99.9	0.1		99	1		87.5	12.5				
PHF	.000	.946	.250	.946	.943	.679	.939	.583	.250	.667			.966

Peggy Malone & Associates

(888) 247-8602

File Name : 13_US 29 & Airport Rd AM
 Site Code :
 Start Date : 4/13/2021
 Page No : 1

Groups Printed- Cars

Start Time	US 29 Southbound					Proffit Rd Westbound					US 29 Northbound					Airport Rd Eastbound					Int. Total
	Right	Thru	Left	Peds	App. Total	Right	Thru	Left	Peds	App. Total	Right	Thru	Left	Peds	App. Total	Right	Thru	Left	Peds	App. Total	
07:00 AM	14	316	26	0	356	17	7	17	0	41	24	131	22	1	178	7	4	8	0	19	594
07:15 AM	17	402	52	0	471	14	9	17	0	40	22	145	21	1	189	15	10	13	0	38	738
07:30 AM	16	446	63	0	525	20	12	18	0	50	31	138	29	0	198	15	18	19	0	52	825
07:45 AM	28	365	49	0	442	41	19	33	0	93	23	183	44	0	250	20	19	29	0	68	853
Total	75	1529	190	0	1794	92	47	85	0	224	100	597	116	2	815	57	51	69	0	177	3010
08:00 AM	18	323	38	0	379	28	19	28	0	75	21	176	39	0	236	15	12	19	0	46	736
08:15 AM	24	333	36	0	393	24	12	24	0	60	23	183	36	0	242	19	8	21	0	48	743
08:30 AM	24	306	37	0	367	22	15	25	0	62	13	165	27	0	205	12	4	23	0	39	673
08:45 AM	36	289	30	0	355	23	10	20	0	53	11	194	28	0	233	12	11	22	0	45	686
Total	102	1251	141	0	1494	97	56	97	0	250	68	718	130	0	916	58	35	85	0	178	2838
Grand Total	177	2780	331	0	3288	189	103	182	0	474	168	1315	246	2	1731	115	86	154	0	355	5848
Apprch %	5.4	84.5	10.1	0		39.9	21.7	38.4	0		9.7	76	14.2	0.1		32.4	24.2	43.4	0		
Total %	3	47.5	5.7	0	56.2	3.2	1.8	3.1	0	8.1	2.9	22.5	4.2	0	29.6	2	1.5	2.6	0	6.1	

Start Time	US 29 Southbound				Proffit Rd Westbound				US 29 Northbound				Airport Rd Eastbound				Int. Total
	Right	Thru	Left	App. Total	Right	Thru	Left	App. Total	Right	Thru	Left	App. Total	Right	Thru	Left	App. Total	
Peak Hour Analysis From 07:00 AM to 08:45 AM - Peak 1 of 1																	
Peak Hour for Entire Intersection Begins at 07:30 AM																	
07:30 AM	16	446	63	525	20	12	18	50	31	138	29	198	15	18	19	52	825
07:45 AM	28	365	49	442	41	19	33	93	23	183	44	250	20	19	29	68	853
08:00 AM	18	323	38	379	28	19	28	75	21	176	39	236	15	12	19	46	736
08:15 AM	24	333	36	393	24	12	24	60	23	183	36	242	19	8	21	48	743
Total Volume	86	1467	186	1739	113	62	103	278	98	680	148	926	69	57	88	214	3157
% App. Total	4.9	84.4	10.7		40.6	22.3	37.1		10.6	73.4	16		32.2	26.6	41.1		
PHF	.768	.822	.738	.828	.689	.816	.780	.747	.790	.929	.841	.926	.863	.750	.759	.787	.925

Peggy Malone & Associates

(888) 247-8602

File Name : 13_US 29 & Airport Rd AM
 Site Code :
 Start Date : 4/13/2021
 Page No : 1

Groups Printed- Trucks

Start Time	US 29 Southbound					Proffit Rd Westbound					US 29 Northbound					Airport Rd Eastbound					Int. Total
	Right	Thru	Left	Peds	App. Total	Right	Thru	Left	Peds	App. Total	Right	Thru	Left	Peds	App. Total	Right	Thru	Left	Peds	App. Total	
07:00 AM	1	18	0	0	19	2	1	1	0	4	0	13	2	0	15	0	0	1	0	1	39
07:15 AM	2	20	0	0	22	4	1	1	0	6	0	13	2	0	15	1	1	1	0	3	46
07:30 AM	2	17	6	0	25	0	0	0	0	0	3	15	1	0	19	3	1	0	0	4	48
07:45 AM	2	13	0	0	15	0	0	1	0	1	1	10	2	0	13	1	0	0	0	1	30
Total	7	68	6	0	81	6	2	3	0	11	4	51	7	0	62	5	2	2	0	9	163
08:00 AM	2	14	2	0	18	1	0	1	0	2	2	10	0	0	12	4	1	0	0	5	37
08:15 AM	1	16	0	0	17	3	0	0	0	3	0	20	0	0	20	1	0	2	0	3	43
08:30 AM	2	18	2	0	22	6	1	0	0	7	0	17	3	0	20	2	0	0	0	2	51
08:45 AM	2	15	0	0	17	1	0	1	0	2	2	16	2	0	20	5	0	0	0	5	44
Total	7	63	4	0	74	11	1	2	0	14	4	63	5	0	72	12	1	2	0	15	175
Grand Total	14	131	10	0	155	17	3	5	0	25	8	114	12	0	134	17	3	4	0	24	338
Apprch %	9	84.5	6.5	0		68	12	20	0		6	85.1	9	0		70.8	12.5	16.7	0		
Total %	4.1	38.8	3	0	45.9	5	0.9	1.5	0	7.4	2.4	33.7	3.6	0	39.6	5	0.9	1.2	0	7.1	

Start Time	US 29 Southbound				Proffit Rd Westbound				US 29 Northbound				Airport Rd Eastbound				Int. Total
	Right	Thru	Left	App. Total	Right	Thru	Left	App. Total	Right	Thru	Left	App. Total	Right	Thru	Left	App. Total	
Peak Hour Analysis From 07:00 AM to 08:45 AM - Peak 1 of 1																	
Peak Hour for Entire Intersection Begins at 08:00 AM																	
08:00 AM	2	14	2	18	1	0	1	2	2	10	0	12	4	1	0	5	37
08:15 AM	1	16	0	17	3	0	0	3	0	20	0	20	1	0	2	3	43
08:30 AM	2	18	2	22	6	1	0	7	0	17	3	20	2	0	0	2	51
08:45 AM	2	15	0	17	1	0	1	2	2	16	2	20	5	0	0	5	44
Total Volume	7	63	4	74	11	1	2	14	4	63	5	72	12	1	2	15	175
% App. Total	9.5	85.1	5.4		78.6	7.1	14.3		5.6	87.5	6.9		80	6.7	13.3		
PHF	.875	.875	.500	.841	.458	.250	.500	.500	.500	.788	.417	.900	.600	.250	.250	.750	.858

Peggy Malone & Associates

(888) 247-8602

File Name : 13_US 29 & Airport Rd AM
 Site Code :
 Start Date : 4/13/2021
 Page No : 1

Groups Printed- Combined

Start Time	US 29 Southbound					Proffit Rd Westbound					US 29 Northbound					Airport Rd Eastbound					Int. Total
	Right	Thru	Left	Peds	App. Total	Right	Thru	Left	Peds	App. Total	Right	Thru	Left	Peds	App. Total	Right	Thru	Left	Peds	App. Total	
07:00 AM	15	334	26	0	375	19	8	18	0	45	24	144	24	1	193	7	4	9	0	20	633
07:15 AM	19	422	52	0	493	18	10	18	0	46	22	158	23	1	204	16	11	14	0	41	784
07:30 AM	18	463	69	0	550	20	12	18	0	50	34	153	30	0	217	18	19	19	0	56	873
07:45 AM	30	378	49	0	457	41	19	34	0	94	24	193	46	0	263	21	19	29	0	69	883
Total	82	1597	196	0	1875	98	49	88	0	235	104	648	123	2	877	62	53	71	0	186	3173
08:00 AM	20	337	40	0	397	29	19	29	0	77	23	186	39	0	248	19	13	19	0	51	773
08:15 AM	25	349	36	0	410	27	12	24	0	63	23	203	36	0	262	20	8	23	0	51	786
08:30 AM	26	324	39	0	389	28	16	25	0	69	13	182	30	0	225	14	4	23	0	41	724
08:45 AM	38	304	30	0	372	24	10	21	0	55	13	210	30	0	253	17	11	22	0	50	730
Total	109	1314	145	0	1568	108	57	99	0	264	72	781	135	0	988	70	36	87	0	193	3013
Grand Total	191	2911	341	0	3443	206	106	187	0	499	176	1429	258	2	1865	132	89	158	0	379	6186
Apprch %	5.5	84.5	9.9	0		41.3	21.2	37.5	0		9.4	76.6	13.8	0.1		34.8	23.5	41.7	0		
Total %	3.1	47.1	5.5	0	55.7	3.3	1.7	3	0	8.1	2.8	23.1	4.2	0	30.1	2.1	1.4	2.6	0	6.1	

Start Time	US 29 Southbound				Proffit Rd Westbound				US 29 Northbound				Airport Rd Eastbound				Int. Total
	Right	Thru	Left	App. Total	Right	Thru	Left	App. Total	Right	Thru	Left	App. Total	Right	Thru	Left	App. Total	
Peak Hour Analysis From 07:00 AM to 08:45 AM - Peak 1 of 1																	
Peak Hour for Entire Intersection Begins at 07:30 AM																	
07:30 AM	18	463	69	550	20	12	18	50	34	153	30	217	18	19	19	56	873
07:45 AM	30	378	49	457	41	19	34	94	24	193	46	263	21	19	29	69	883
08:00 AM	20	337	40	397	29	19	29	77	23	186	39	248	19	13	19	51	773
08:15 AM	25	349	36	410	27	12	24	63	23	203	36	262	20	8	23	51	786
Total Volume	93	1527	194	1814	117	62	105	284	104	735	151	990	78	59	90	227	3315
% App. Total	5.1	84.2	10.7		41.2	21.8	37		10.5	74.2	15.3		34.4	26	39.6		
PHF	.775	.825	.703	.825	.713	.816	.772	.755	.765	.905	.821	.941	.929	.776	.776	.822	.939

Peggy Malone & Associates

(888) 247-8602

File Name : 13_US 29 & Airport Rd PM
 Site Code :
 Start Date : 4/13/2021
 Page No : 1

Groups Printed- Cars

Start Time	US 29 Southbound					Proffit Rd Westbound					US 29 Northbound					Airport Rd Eastbound					Int. Total
	Right	Thru	Left	Peds	App. Total	Right	Thru	Left	Peds	App. Total	Right	Thru	Left	Peds	App. Total	Right	Thru	Left	Peds	App. Total	
04:00 PM	21	261	30	0	312	17	12	41	0	70	25	341	15	0	381	28	16	20	0	64	827
04:15 PM	22	266	33	0	321	44	9	22	0	75	30	337	20	0	387	22	12	18	0	52	835
04:30 PM	15	258	36	0	309	19	14	25	0	58	27	368	17	0	412	28	23	27	0	78	857
04:45 PM	21	265	39	0	325	36	22	37	0	95	38	392	26	0	456	25	15	23	0	63	939
Total	79	1050	138	0	1267	116	57	125	0	298	120	1438	78	0	1636	103	66	88	0	257	3458
05:00 PM	17	257	37	0	311	39	8	23	0	70	39	411	23	0	473	51	30	35	0	116	970
05:15 PM	27	256	35	0	318	42	21	22	0	85	40	438	17	0	495	47	12	31	0	90	988
05:30 PM	22	223	33	0	278	43	15	21	0	79	46	375	19	0	440	20	10	22	0	52	849
05:45 PM	13	218	30	0	261	34	14	14	0	62	29	314	25	0	368	19	11	26	0	56	747
Total	79	954	135	0	1168	158	58	80	0	296	154	1538	84	0	1776	137	63	114	0	314	3554
Grand Total	158	2004	273	0	2435	274	115	205	0	594	274	2976	162	0	3412	240	129	202	0	571	7012
Apprch %	6.5	82.3	11.2	0		46.1	19.4	34.5	0		8	87.2	4.7	0		42	22.6	35.4	0		
Total %	2.3	28.6	3.9	0	34.7	3.9	1.6	2.9	0	8.5	3.9	42.4	2.3	0	48.7	3.4	1.8	2.9	0	8.1	

Start Time	US 29 Southbound				Proffit Rd Westbound				US 29 Northbound				Airport Rd Eastbound				Int. Total
	Right	Thru	Left	App. Total	Right	Thru	Left	App. Total	Right	Thru	Left	App. Total	Right	Thru	Left	App. Total	
Peak Hour Analysis From 04:00 PM to 05:45 PM - Peak 1 of 1																	
Peak Hour for Entire Intersection Begins at 04:30 PM																	
04:30 PM	15	258	36	309	19	14	25	58	27	368	17	412	28	23	27	78	857
04:45 PM	21	265	39	325	36	22	37	95	38	392	26	456	25	15	23	63	939
05:00 PM	17	257	37	311	39	8	23	70	39	411	23	473	51	30	35	116	970
05:15 PM	27	256	35	318	42	21	22	85	40	438	17	495	47	12	31	90	988
Total Volume	80	1036	147	1263	136	65	107	308	144	1609	83	1836	151	80	116	347	3754
% App. Total	6.3	82	11.6		44.2	21.1	34.7		7.8	87.6	4.5		43.5	23.1	33.4		
PHF	.741	.977	.942	.972	.810	.739	.723	.811	.900	.918	.798	.927	.740	.667	.829	.748	.950

Peggy Malone & Associates

(888) 247-8602

File Name : 13_US 29 & Airport Rd PM
 Site Code :
 Start Date : 4/13/2021
 Page No : 1

Groups Printed- Trucks

Start Time	US 29 Southbound					Proffit Rd Westbound					US 29 Northbound					Airport Rd Eastbound					Int. Total
	Right	Thru	Left	Peds	App. Total	Right	Thru	Left	Peds	App. Total	Right	Thru	Left	Peds	App. Total	Right	Thru	Left	Peds	App. Total	
04:00 PM	2	14	0	0	16	1	0	0	0	1	0	9	0	0	9	2	0	0	0	2	28
04:15 PM	0	14	0	0	14	1	1	0	0	2	0	15	3	0	18	1	0	0	0	1	35
04:30 PM	1	20	2	0	23	0	0	1	0	1	1	16	1	0	18	1	0	1	0	2	44
04:45 PM	0	10	2	0	12	0	2	2	0	4	1	17	1	0	19	1	0	0	0	1	36
Total	3	58	4	0	65	2	3	3	0	8	2	57	5	0	64	5	0	1	0	6	143
05:00 PM	3	6	3	0	12	0	0	0	0	0	2	11	0	0	13	0	1	0	0	1	26
05:15 PM	1	4	0	0	5	0	0	2	0	2	0	8	0	0	8	1	2	0	0	3	18
05:30 PM	0	3	0	0	3	1	1	2	0	4	0	4	1	0	5	0	0	0	0	0	12
05:45 PM	1	7	0	0	8	0	0	0	0	0	1	6	0	0	7	1	0	0	0	1	16
Total	5	20	3	0	28	1	1	4	0	6	3	29	1	0	33	2	3	0	0	5	72
Grand Total	8	78	7	0	93	3	4	7	0	14	5	86	6	0	97	7	3	1	0	11	215
Apprch %	8.6	83.9	7.5	0		21.4	28.6	50	0		5.2	88.7	6.2	0		63.6	27.3	9.1	0		
Total %	3.7	36.3	3.3	0	43.3	1.4	1.9	3.3	0	6.5	2.3	40	2.8	0	45.1	3.3	1.4	0.5	0	5.1	

Start Time	US 29 Southbound				Proffit Rd Westbound				US 29 Northbound				Airport Rd Eastbound				Int. Total
	Right	Thru	Left	App. Total	Right	Thru	Left	App. Total	Right	Thru	Left	App. Total	Right	Thru	Left	App. Total	
Peak Hour Analysis From 04:00 PM to 05:45 PM - Peak 1 of 1																	
Peak Hour for Entire Intersection Begins at 04:00 PM																	
04:00 PM	2	14	0	16	1	0	0	1	0	9	0	9	2	0	0	2	28
04:15 PM	0	14	0	14	1	1	0	2	0	15	3	18	1	0	0	1	35
04:30 PM	1	20	2	23	0	0	1	1	1	16	1	18	1	0	1	2	44
04:45 PM	0	10	2	12	0	2	2	4	1	17	1	19	1	0	0	1	36
Total Volume	3	58	4	65	2	3	3	8	2	57	5	64	5	0	1	6	143
% App. Total	4.6	89.2	6.2		25	37.5	37.5		3.1	89.1	7.8		83.3	0	16.7		
PHF	.375	.725	.500	.707	.500	.375	.375	.500	.500	.838	.417	.842	.625	.000	.250	.750	.813

Peggy Malone & Associates
(888) 247-8602

File Name : 13_US 29 & Airport Rd PM
 Site Code :
 Start Date : 4/13/2021
 Page No : 1

Groups Printed- Combined

Start Time	US 29 Southbound					Proffit Rd Westbound					US 29 Northbound					Airport Rd Eastbound					Int. Total
	Right	Thru	Left	Peds	App. Total	Right	Thru	Left	Peds	App. Total	Right	Thru	Left	Peds	App. Total	Right	Thru	Left	Peds	App. Total	
04:00 PM	23	275	30	0	328	18	12	41	0	71	25	350	15	0	390	30	16	20	0	66	855
04:15 PM	22	280	33	0	335	45	10	22	0	77	30	352	23	0	405	23	12	18	0	53	870
04:30 PM	16	278	38	0	332	19	14	26	0	59	28	384	18	0	430	29	23	28	0	80	901
04:45 PM	21	275	41	0	337	36	24	39	0	99	39	409	27	0	475	26	15	23	0	64	975
Total	82	1108	142	0	1332	118	60	128	0	306	122	1495	83	0	1700	108	66	89	0	263	3601
05:00 PM	20	263	40	0	323	39	8	23	0	70	41	422	23	0	486	51	31	35	0	117	996
05:15 PM	28	260	35	0	323	42	21	24	0	87	40	446	17	0	503	48	14	31	0	93	1006
05:30 PM	22	226	33	0	281	44	16	23	0	83	46	379	20	0	445	20	10	22	0	52	861
05:45 PM	14	225	30	0	269	34	14	14	0	62	30	320	25	0	375	20	11	26	0	57	763
Total	84	974	138	0	1196	159	59	84	0	302	157	1567	85	0	1809	139	66	114	0	319	3626
Grand Total	166	2082	280	0	2528	277	119	212	0	608	279	3062	168	0	3509	247	132	203	0	582	7227
Apprch %	6.6	82.4	11.1	0		45.6	19.6	34.9	0		8	87.3	4.8	0		42.4	22.7	34.9	0		
Total %	2.3	28.8	3.9	0	35	3.8	1.6	2.9	0	8.4	3.9	42.4	2.3	0	48.6	3.4	1.8	2.8	0	8.1	























Start Time	US 29 Southbound				Proffit Rd Westbound				US 29 Northbound				Airport Rd Eastbound				Int. Total
	Right	Thru	Left	App. Total	Right	Thru	Left	App. Total	Right	Thru	Left	App. Total	Right	Thru	Left	App. Total	
Peak Hour Analysis From 04:00 PM to 05:45 PM - Peak 1 of 1																	
Peak Hour for Entire Intersection Begins at 04:30 PM																	
04:30 PM	16	278	38	332	19	14	26	59	28	384	18	430	29	23	28	80	901
04:45 PM	21	275	41	337	36	24	39	99	39	409	27	475	26	15	23	64	975
05:00 PM	20	263	40	323	39	8	23	70	41	422	23	486	51	31	35	117	996
05:15 PM	28	260	35	323	42	21	24	87	40	446	17	503	48	14	31	93	1006
Total Volume	85	1076	154	1315	136	67	112	315	148	1661	85	1894	154	83	117	354	3878
% App. Total	6.5	81.8	11.7		43.2	21.3	35.6		7.8	87.7	4.5		43.5	23.4	33.1		
PHF	.759	.968	.939	.976	.810	.698	.718	.795	.902	.931	.787	.941	.755	.669	.836	.756	.964

Attachment B Existing
Traffic
Conditions
Analysis

HCM Unsignalized Intersection Capacity Analysis

1: US 29 & Deerfield Drive

05/31/2021

												
Movement	EBL	EBT	EBR	WBL	WBT	WBR	NBL	NBT	NBR	SBL	SBT	SBR
Lane Configurations								 			 	
Traffic Volume (veh/h)	11	1	27	1	0	0	13	749	0	0	1306	18
Future Volume (Veh/h)	11	1	27	1	0	0	13	749	0	0	1306	18
Sign Control		Stop			Stop			Free			Free	
Grade		0%			0%			0%			0%	
Peak Hour Factor	0.90	0.90	0.90	0.90	0.90	0.90	0.90	0.90	0.90	0.90	0.90	0.90
Hourly flow rate (vph)	12	1	30	1	0	0	14	832	0	0	1451	20
Pedestrians												
Lane Width (ft)												
Walking Speed (ft/s)												
Percent Blockage												
Right turn flare (veh)												
Median type												
Median storage (veh)												
Upstream signal (ft)												
pX, platoon unblocked	0.86	0.86		0.86	0.86	0.86					0.86	
vC, conflicting volume	1895	2311	726	1586	2331	416	1471				832	
vC1, stage 1 conf vol	1451	1451		860	860							
vC2, stage 2 conf vol	444	860		726	1471							
vCu, unblocked vol	1720	2202	726	1362	2225	7	1471				489	
tC, single (s)	7.5	6.5	7.1	7.5	6.5	6.9	4.3				4.1	
tC, 2 stage (s)	6.5	5.5		6.5	5.5							
tF (s)	3.5	4.0	3.4	3.5	4.0	3.3	2.3				2.2	
p0 queue free %	91	99	91	100	100	100	97				100	
cM capacity (veh/h)	135	177	348	270	163	933	426				937	
Direction, Lane #	EB 1	WB 1	NB 1	NB 2	NB 3	NB 4	SB 1	SB 2	SB 3	SB 4		
Volume Total	43	1	14	416	416	0	0	726	726	20		
Volume Left	12	1	14	0	0	0	0	0	0	0		
Volume Right	30	0	0	0	0	0	0	0	0	20		
cSH	458	270	426	1700	1700	1700	1700	1700	1700	1700		
Volume to Capacity	0.09	0.00	0.03	0.24	0.24	0.00	0.00	0.43	0.43	0.01		
Queue Length 95th (ft)	8	0	3	0	0	0	0	0	0	0		
Control Delay (s)	21.6	18.4	13.7	0.0	0.0	0.0	0.0	0.0	0.0	0.0		
Lane LOS	C	C	B									
Approach Delay (s)	21.6	18.4	0.2									
Approach LOS	C	C										
Intersection Summary												
Average Delay			0.5									
Intersection Capacity Utilization			52.8%	ICU Level of Service		A						
Analysis Period (min)			15									

Queues

2: US 29 & Matthew Mill Road

05/31/2021



Lane Group	EBT	EBR	WBL	WBT	WBR	NBL	NBT	NBR	SBL	SBT	SBR
Lane Group Flow (vph)	135	182	245	248	81	41	610	120	67	1357	18
v/c Ratio	0.82	0.49	0.76	0.76	0.19	0.32	0.50	0.18	0.55	0.95	0.03
Control Delay	82.2	13.4	56.7	57.2	1.0	55.0	29.7	2.3	65.9	48.3	0.1
Queue Delay	0.0	0.0	0.0	0.0	0.0	0.0	0.0	0.0	0.0	0.0	0.0
Total Delay	82.2	13.4	56.7	57.2	1.0	55.0	29.7	2.3	65.9	48.3	0.1
Queue Length 50th (ft)	92	7	171	173	0	28	186	0	46	~593	0
Queue Length 95th (ft)	#216	74	255	257	0	63	246	20	93	#744	0
Internal Link Dist (ft)	263			737			534			690	
Turn Bay Length (ft)			600		575	300		355	625		
Base Capacity (vph)	165	368	393	394	482	144	1225	672	130	1431	716
Starvation Cap Reductn	0	0	0	0	0	0	0	0	0	0	0
Spillback Cap Reductn	0	0	0	0	0	0	0	0	0	0	0
Storage Cap Reductn	0	0	0	0	0	0	0	0	0	0	0
Reduced v/c Ratio	0.82	0.49	0.62	0.63	0.17	0.28	0.50	0.18	0.52	0.95	0.03

Intersection Summary

~ Volume exceeds capacity, queue is theoretically infinite.

Queue shown is maximum after two cycles.























95th percentile volume exceeds capacity, queue may be longer.

Queue shown is maximum after two cycles.

HCM Signalized Intersection Capacity Analysis

2: US 29 & Matthew Mill Road

05/31/2021

													
Movement	EBL	EBT	EBR	WBL	WBT	WBR	NBL	NBT	NBR	SBL	SBT	SBR	
Lane Configurations													
Traffic Volume (vph)	78	45	166	412	36	74	37	555	109	61	1235	16	
Future Volume (vph)	78	45	166	412	36	74	37	555	109	61	1235	16	
Ideal Flow (vphpl)	1900	1900	1900	1900	1900	1900	1900	1900	1900	1900	1900	1900	
Total Lost time (s)		6.5	6.5	6.5	6.5	6.5	6.0	7.0	7.0	6.0	7.0	7.0	
Lane Util. Factor		1.00	1.00	0.95	0.95	1.00	1.00	0.95	1.00	1.00	0.95	1.00	
Frt		1.00	0.85	1.00	1.00	0.85	1.00	1.00	0.85	1.00	1.00	0.85	
Flt Protected		0.97	1.00	0.95	0.96	1.00	0.95	1.00	1.00	0.95	1.00	1.00	
Satd. Flow (prot)		1749	1599	1698	1702	1538	1770	3223	1509	1597	3505	1524	
Flt Permitted		0.66	1.00	0.95	0.96	1.00	0.95	1.00	1.00	0.95	1.00	1.00	
Satd. Flow (perm)		1191	1599	1698	1702	1538	1770	3223	1509	1597	3505	1524	
Peak-hour factor, PHF	0.91	0.91	0.91	0.91	0.91	0.91	0.91	0.91	0.91	0.91	0.91	0.91	
Adj. Flow (vph)	86	49	182	453	40	81	41	610	120	67	1357	18	
RTOR Reduction (vph)	0	0	146	0	0	66	0	0	76	0	0	11	
Lane Group Flow (vph)	0	135	36	245	248	15	41	610	44	67	1357	7	
Heavy Vehicles (%)	6%	4%	1%	1%	6%	5%	2%	12%	7%	13%	3%	6%	
Turn Type	Perm	NA	Prot	Split	NA	Prot	Prot	NA	Prot	Prot	NA	Prot	
Protected Phases		4	4	3	3	3	5	2	2	1	6	6	
Permitted Phases	4												
Actuated Green, G (s)		15.3	15.3	21.0	21.0	21.0	5.2	40.6	40.6	7.1	42.5	42.5	
Effective Green, g (s)		15.3	15.3	21.0	21.0	21.0	5.2	40.6	40.6	7.1	42.5	42.5	
Actuated g/C Ratio		0.14	0.14	0.19	0.19	0.19	0.05	0.37	0.37	0.06	0.39	0.39	
Clearance Time (s)		6.5	6.5	6.5	6.5	6.5	6.0	7.0	7.0	6.0	7.0	7.0	
Vehicle Extension (s)		3.0	3.0	3.0	3.0	3.0	3.0	6.0	6.0	3.0	6.0	6.0	
Lane Grp Cap (vph)		165	222	324	324	293	83	1189	556	103	1354	588	
v/s Ratio Prot			0.02	0.14	c0.15	0.01	0.02	0.19	0.03	c0.04	c0.39	0.00	
v/s Ratio Perm	c0.11												
v/c Ratio		0.82	0.16	0.76	0.77	0.05	0.49	0.51	0.08	0.65	1.00	0.01	
Uniform Delay, d1		46.0	41.7	42.1	42.2	36.4	51.1	27.0	22.6	50.2	33.8	20.8	
Progression Factor		1.00	1.00	1.00	1.00	1.00	1.00	1.00	1.00	1.00	1.00	1.00	
Incremental Delay, d2		25.9	0.3	9.7	10.3	0.1	4.6	1.6	0.3	13.8	25.0	0.0	
Delay (s)		71.9	42.0	51.7	52.5	36.4	55.7	28.6	22.8	64.0	58.7	20.8	
Level of Service		E	D	D	D	D	E	C	C	E	E	C	
Approach Delay (s)		54.8			49.9			29.1			58.5		
Approach LOS		D			D			C			E		
Intersection Summary													
HCM 2000 Control Delay			49.2		HCM 2000 Level of Service						D		
HCM 2000 Volume to Capacity ratio			0.90										
Actuated Cycle Length (s)			110.0		Sum of lost time (s)					26.0			
Intersection Capacity Utilization			75.2%		ICU Level of Service					D			
Analysis Period (min)			15										
c Critical Lane Group													

HCM Unsignalized Intersection Capacity Analysis

3: US 29 & Heatherton Drive



















05/31/2021



Movement	EBL	EBR	NBL	NBT	SBT	SBR	
Lane Configurations							
Traffic Volume (veh/h)	12	31	62	689	1809	4	
Future Volume (Veh/h)	12	31	62	689	1809	4	
Sign Control	Stop			Free	Free		
Grade	0%			0%	0%		
Peak Hour Factor	0.95	0.95	0.95	0.95	0.95	0.95	
Hourly flow rate (vph)	13	33	65	725	1904	4	
Pedestrians							
Lane Width (ft)							
Walking Speed (ft/s)							
Percent Blockage							
Right turn flare (veh)							
Median type				Raised	Raised		
Median storage (veh)				2	2		
Upstream signal (ft)				614			
pX, platoon unblocked	0.62	0.62	0.62				
vC, conflicting volume	2396	952	1908				
vC1, stage 1 conf vol	1904						
vC2, stage 2 conf vol	492						
vCu, unblocked vol	2030	0	1245				
tC, single (s)	6.8	6.9	4.1				
tC, 2 stage (s)	5.8						
tF (s)	3.5	3.3	2.2				
p0 queue free %	91	95	82				
cM capacity (veh/h)	139	679	352				
Direction, Lane #	EB 1	NB 1	NB 2	NB 3	SB 1	SB 2	SB 3
Volume Total	46	65	362	362	952	952	4
Volume Left	13	65	0	0	0	0	0
Volume Right	33	0	0	0	0	0	4
cSH	324	352	1700	1700	1700	1700	1700
Volume to Capacity	0.14	0.18	0.21	0.21	0.56	0.56	0.00
Queue Length 95th (ft)	12	17	0	0	0	0	0
Control Delay (s)	17.9	17.5	0.0	0.0	0.0	0.0	0.0
Lane LOS	C	C					
Approach Delay (s)	17.9	1.4	0.0				
Approach LOS	C						
Intersection Summary							
Average Delay	0.7						
Intersection Capacity Utilization	61.5%			ICU Level of Service	B		
Analysis Period (min)	15						

HCM Unsignalized Intersection Capacity Analysis
 4: US 29 & Terrace Greene Circle

06/10/2021

												
Movement	EBL	EBT	EBR	WBL	WBT	WBR	NBL	NBT	NBR	SBL	SBT	SBR
Lane Configurations												
Traffic Volume (veh/h)	0	0	3	0	0	75	0	653	13	0	1745	4
Future Volume (Veh/h)	0	0	3	0	0	75	0	653	13	0	1745	4
Sign Control	Stop			Stop			Free			Free		
Grade	0%			0%			0%			0%		
Peak Hour Factor	0.92	0.92	0.92	0.92	0.92	0.92	0.97	0.97	0.97	0.97	0.97	0.97
Hourly flow rate (vph)	0	0	3	0	0	82	0	673	13	0	1799	4
Pedestrians												
Lane Width (ft)												
Walking Speed (ft/s)												
Percent Blockage												
Right turn flare (veh)												
Median type							Raised			Raised		
Median storage veh							2			2		
Upstream signal (ft)												
pX, platoon unblocked												
vC, conflicting volume	2218	2485	900	1576	2476	336	1803				686	
vC1, stage 1 conf vol	1799	1799		673	673							
vC2, stage 2 conf vol	418	686		902	1803							
vCu, unblocked vol	2218	2485	900	1576	2476	336	1803				686	
tC, single (s)	7.5	6.5	6.9	7.5	6.5	6.9	4.1				4.1	
tC, 2 stage (s)	6.5	5.5		6.5	5.5							
tF (s)	3.5	4.0	3.3	3.5	4.0	3.3	2.2				2.2	
p0 queue free %	100	100	99	100	100	88	100				100	
cM capacity (veh/h)	80	123	282	244	122	659	346				910	
Direction, Lane #	EB 1	WB 1	NB 1	NB 2	NB 3	SB 1	SB 2	SB 3				
Volume Total	3	82	336	336	13	900	900	4				
Volume Left	0	0	0	0	0	0	0	0				
Volume Right	3	82	0	0	13	0	0	4				
cSH	282	659	1700	1700	1700	1700	1700	1700				
Volume to Capacity	0.01	0.12	0.20	0.20	0.01	0.53	0.53	0.00				
Queue Length 95th (ft)	1	11	0	0	0	0	0	0				
Control Delay (s)	17.9	11.2	0.0	0.0	0.0	0.0	0.0	0.0				
Lane LOS	C	B										
Approach Delay (s)	17.9	11.2	0.0					0.0				
Approach LOS	C	B										
Intersection Summary												
Average Delay			0.4									
Intersection Capacity Utilization			58.2%	ICU Level of Service				B				
Analysis Period (min)			15									

HCM Unsignalized Intersection Capacity Analysis

5: US 29 & Keleigh Lane





















05/31/2021



Movement	EBL	EBR	NBL	NBT	SBT	SBR	
Lane Configurations							
Traffic Volume (veh/h)	13	33	9	670	1872	9	
Future Volume (Veh/h)	13	33	9	670	1872	9	
Sign Control	Stop			Free	Free		
Grade	0%			0%	0%		
Peak Hour Factor	0.95	0.95	0.95	0.95	0.95	0.95	
Hourly flow rate (vph)	14	35	9	705	1971	9	
Pedestrians							
Lane Width (ft)							
Walking Speed (ft/s)							
Percent Blockage							
Right turn flare (veh)							
Median type			Raised	Raised			
Median storage (veh)			2	2			
Upstream signal (ft)							
pX, platoon unblocked							
vC, conflicting volume	2342	986	1980				
vC1, stage 1 conf vol	1971						
vC2, stage 2 conf vol	370						
vCu, unblocked vol	2342	986	1980				
tC, single (s)	6.8	7.0	4.3				
tC, 2 stage (s)	5.8						
tF (s)	3.5	3.3	2.3				
p0 queue free %	85	86	96				
cM capacity (veh/h)	94	245	256				
Direction, Lane #	EB 1	NB 1	NB 2	NB 3	SB 1	SB 2	SB 3
Volume Total	49	9	352	352	986	986	9
Volume Left	14	9	0	0	0	0	0
Volume Right	35	0	0	0	0	0	9
cSH	168	256	1700	1700	1700	1700	1700
Volume to Capacity	0.29	0.04	0.21	0.21	0.58	0.58	0.01
Queue Length 95th (ft)	29	3	0	0	0	0	0
Control Delay (s)	35.1	19.6	0.0	0.0	0.0	0.0	0.0
Lane LOS	E	C					
Approach Delay (s)	35.1	0.2	0.0				
Approach LOS	E						
Intersection Summary							
Average Delay			0.7				
Intersection Capacity Utilization			61.7%	ICU Level of Service	B		
Analysis Period (min)			15				

HCM Unsignalized Intersection Capacity Analysis
6: US 29 & Commercial Entrance

05/31/2021

												
Movement	EBL	EBT	EBR	WBL	WBT	WBR	NBL	NBT	NBR	SBL	SBT	SBR
Lane Configurations												
Traffic Volume (veh/h)	0	0	0	55	0	13	22	540	25	73	1769	0
Future Volume (Veh/h)	0	0	0	55	0	13	22	540	25	73	1769	0
Sign Control		Stop			Stop			Free			Free	
Grade		0%			0%			0%			0%	
Peak Hour Factor	0.92	0.92	0.92	0.92	0.92	0.92	0.92	0.92	0.92	0.92	0.92	0.92
Hourly flow rate (vph)	0	0	0	60	0	14	24	587	27	79	1923	0
Pedestrians												
Lane Width (ft)												
Walking Speed (ft/s)												
Percent Blockage												
Right turn flare (veh)												
Median type												
Median storage veh												
Upstream signal (ft)												
pX, platoon unblocked												
vC, conflicting volume	2430	2743	962	1754	2716	294	1923			614		
vC1, stage 1 conf vol	2081	2081		635	635							
vC2, stage 2 conf vol	348	662		1120	2081							
vCu, unblocked vol	2430	2743	962	1754	2716	294	1923			614		
tC, single (s)	7.5	6.5	6.9	7.5	6.5	7.1	4.1			4.2		
tC, 2 stage (s)	6.5	5.5		6.5	5.5							
tF (s)	3.5	4.0	3.3	3.5	4.0	3.4	2.2			2.2		
p0 queue free %	100	100	100	64	100	98	92			92		
cM capacity (veh/h)	50	84	260	165	62	685	311			955		
Direction, Lane #	EB 1	WB 1	NB 1	NB 2	NB 3	NB 4	SB 1	SB 2	SB 3			
Volume Total	0	74	24	294	294	27	79	962	962			
Volume Left	0	60	24	0	0	0	79	0	0			
Volume Right	0	14	0	0	0	27	0	0	0			
cSH	1700	203	311	1700	1700	1700	955	1700	1700			
Volume to Capacity	0.00	0.36	0.08	0.17	0.17	0.02	0.08	0.57	0.57			
Queue Length 95th (ft)	0	39	6	0	0	0	7	0	0			
Control Delay (s)	0.0	33.4	17.5	0.0	0.0	0.0	9.1	0.0	0.0			
Lane LOS	A	D	C				A					
Approach Delay (s)	0.0	33.4	0.7				0.4					
Approach LOS	A	D										
Intersection Summary												
Average Delay			1.3									
Intersection Capacity Utilization			65.6%		ICU Level of Service				C			
Analysis Period (min)			15									

HCM Unsignalized Intersection Capacity Analysis

7: US 29 & Lake Saponi Drive

05/31/2021



Movement	WBL	WBR	NBT	NBR	SBL	SBT
Lane Configurations		↗	↕	↗		↕
Traffic Volume (veh/h)	0	38	541	13	0	1850
Future Volume (Veh/h)	0	38	541	13	0	1850
Sign Control	Stop		Free			Free
Grade	0%		0%			0%
Peak Hour Factor	0.91	0.91	0.91	0.91	0.91	0.91
Hourly flow rate (vph)	0	42	595	14	0	2033
Pedestrians						
Lane Width (ft)						
Walking Speed (ft/s)						
Percent Blockage						
Right turn flare (veh)						
Median type			Raised			Raised
Median storage (veh)			2			2
Upstream signal (ft)						
pX, platoon unblocked						
vC, conflicting volume	1612	298			609	
vC1, stage 1 conf vol	595					
vC2, stage 2 conf vol	1016					
vCu, unblocked vol	1612	298			609	
tC, single (s)	6.8	7.1			4.1	
tC, 2 stage (s)	5.8					
tF (s)	3.5	3.4			2.2	
p0 queue free %	100	94			100	
cM capacity (veh/h)	276	681			979	
Direction, Lane #	WB 1	NB 1	NB 2	NB 3	SB 1	SB 2
Volume Total	42	298	298	14	1016	1016
Volume Left	0	0	0	0	0	0
Volume Right	42	0	0	14	0	0
cSH	681	1700	1700	1700	1700	1700
Volume to Capacity	0.06	0.17	0.17	0.01	0.60	0.60
Queue Length 95th (ft)	5	0	0	0	0	0
Control Delay (s)	10.6	0.0	0.0	0.0	0.0	0.0
Lane LOS	B					
Approach Delay (s)	10.6	0.0			0.0	
Approach LOS	B					
Intersection Summary						
Average Delay			0.2			
Intersection Capacity Utilization			54.5%	ICU Level of Service	A	
Analysis Period (min)			15			

HCM Unsignalized Intersection Capacity Analysis

8: US 29 & Greene Edge Lane

05/31/2021



Movement	EBL	EBR	NBL	NBT	SBT	SBR
Lane Configurations						
Traffic Volume (veh/h)	0	1	1	624	1923	0
Future Volume (Veh/h)	0	1	1	624	1923	0
Sign Control	Stop			Free	Free	
Grade	0%			0%	0%	
Peak Hour Factor	0.92	0.92	0.92	0.92	0.92	0.92
Hourly flow rate (vph)	0	1	1	678	2090	0
Pedestrians						
Lane Width (ft)						
Walking Speed (ft/s)						
Percent Blockage						
Right turn flare (veh)						
Median type				Raised	Raised	
Median storage (veh)				2	2	
Upstream signal (ft)						
pX, platoon unblocked						
vC, conflicting volume	2431	1045	2090			
vC1, stage 1 conf vol	2090					
vC2, stage 2 conf vol	341					
vCu, unblocked vol	2431	1045	2090			
tC, single (s)	6.8	6.9	4.1			
tC, 2 stage (s)	5.8					
tF (s)	3.5	3.3	2.2			
p0 queue free %	100	100	100			
cM capacity (veh/h)	81	229	268			
Direction, Lane #	EB 1	NB 1	NB 2	SB 1	SB 2	
Volume Total	1	227	452	1393	697	
Volume Left	0	1	0	0	0	
Volume Right	1	0	0	0	0	
cSH	229	268	1700	1700	1700	
Volume to Capacity	0.00	0.00	0.27	0.82	0.41	
Queue Length 95th (ft)	0	0	0	0	0	
Control Delay (s)	20.8	0.2	0.0	0.0	0.0	
Lane LOS	C	A				
Approach Delay (s)	20.8	0.1		0.0		
Approach LOS	C					
Intersection Summary						
Average Delay	0.0					
Intersection Capacity Utilization	63.2%			ICU Level of Service	B	
Analysis Period (min)	15					

Queues

9: US 29 & Frays Mill Road

05/31/2021



Lane Group	EBT	WBT	NBL	NBT	NBR	SBL	SBT	SBR
Lane Group Flow (vph)	238	196	10	640	28	39	2182	16
v/c Ratio	0.75	3.02	0.08	0.36	0.03	0.30	1.04	0.02
Control Delay	31.4	964.6	49.0	16.3	0.1	54.1	52.5	0.0
Queue Delay	0.0	0.0	0.0	0.0	0.0	0.0	0.0	0.0
Total Delay	31.4	964.6	49.0	16.3	0.1	54.1	52.5	0.0
Queue Length 50th (ft)	52	~238	7	144	0	27	744	0
Queue Length 95th (ft)	#139	#386	25	198	0	61	#1174	0
Internal Link Dist (ft)	273	256		1061			946	
Turn Bay Length (ft)			350		350	375		375
Base Capacity (vph)	344	65	147	1776	827	139	2108	1030
Starvation Cap Reductn	0	0	0	0	0	0	0	0
Spillback Cap Reductn	0	0	0	0	0	0	0	0
Storage Cap Reductn	0	0	0	0	0	0	0	0
Reduced v/c Ratio	0.69	3.02	0.07	0.36	0.03	0.28	1.04	0.02

Intersection Summary

~ Volume exceeds capacity, queue is theoretically infinite.

Queue shown is maximum after two cycles.

95th percentile volume exceeds capacity, queue may be longer.

Queue shown is maximum after two cycles.

HCM Signalized Intersection Capacity Analysis

9: US 29 & Frays Mill Road

05/31/2021

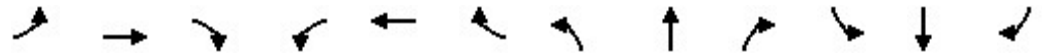



















Movement	EBL	EBT	EBR	WBL	WBT	WBR	NBL	NBT	NBR	SBL	SBT	SBR
Lane Configurations		↔			↔		↗	↕	↗	↗	↕	↗
Traffic Volume (vph)	11	8	195	132	8	36	9	576	25	35	1964	14
Future Volume (vph)	11	8	195	132	8	36	9	576	25	35	1964	14
Ideal Flow (vphpl)	1900	1900	1900	1900	1900	1900	1900	1900	1900	1900	1900	1900
Total Lost time (s)		6.0			6.0		6.0	6.0	6.0	6.0	6.0	6.0
Lane Util. Factor		1.00			1.00		1.00	0.95	1.00	1.00	0.95	1.00
Frt		0.88			0.97		1.00	1.00	0.85	1.00	1.00	0.85
Flt Protected		1.00			0.96		0.95	1.00	1.00	0.95	1.00	1.00
Satd. Flow (prot)		1647			1747		1805	3252	1392	1703	3505	1615
Flt Permitted		0.97			0.32		0.95	1.00	1.00	0.95	1.00	1.00
Satd. Flow (perm)		1603			577		1805	3252	1392	1703	3505	1615
Peak-hour factor, PHF	0.90	0.90	0.90	0.90	0.90	0.90	0.90	0.90	0.90	0.90	0.90	0.90
Adj. Flow (vph)	12	9	217	147	9	40	10	640	28	39	2182	16
RTOR Reduction (vph)	0	143	0	0	8	0	0	0	13	0	0	7
Lane Group Flow (vph)	0	95	0	0	188	0	10	640	15	39	2182	9
Heavy Vehicles (%)	18%	0%	0%	1%	13%	3%	0%	11%	16%	6%	3%	0%
Turn Type	Perm	NA		Perm	NA		Prot	NA	Prot	Prot	NA	Prot
Protected Phases		4			3		5	2	2	1	6	6
Permitted Phases	4			3								
Actuated Green, G (s)		12.0			11.0		1.6	57.7	57.7	5.3	61.4	61.4
Effective Green, g (s)		12.0			11.0		1.6	57.7	57.7	5.3	61.4	61.4
Actuated g/C Ratio		0.11			0.10		0.01	0.52	0.52	0.05	0.56	0.56
Clearance Time (s)		6.0			6.0		6.0	6.0	6.0	6.0	6.0	6.0
Vehicle Extension (s)		4.0			4.0		3.5	6.0	6.0	3.5	6.0	6.0
Lane Grp Cap (vph)		174			57		26	1705	730	82	1956	901
v/s Ratio Prot							0.01	0.20	0.01	c0.02	c0.62	0.01
v/s Ratio Perm		c0.06			c0.33							
v/c Ratio		0.54			3.30		0.38	0.38	0.02	0.48	1.12	0.01
Uniform Delay, d1		46.4			49.5		53.7	15.5	12.6	51.0	24.3	10.8
Progression Factor		1.00			1.00		1.00	1.00	1.00	1.00	1.00	1.00
Incremental Delay, d2		4.3			1076.9		10.8	0.6	0.1	5.1	59.7	0.0
Delay (s)		50.7			1126.4		64.5	16.1	12.6	56.1	84.0	10.8
Level of Service		D			F		E	B	B	E	F	B
Approach Delay (s)		50.7			1126.4		16.7				83.0	
Approach LOS		D			F		B				F	

Intersection Summary

HCM 2000 Control Delay	128.4	HCM 2000 Level of Service	F
HCM 2000 Volume to Capacity ratio	1.32		
Actuated Cycle Length (s)	110.0	Sum of lost time (s)	24.0
Intersection Capacity Utilization	92.3%	ICU Level of Service	F
Analysis Period (min)	15		
c Critical Lane Group			

HCM Unsignalized Intersection Capacity Analysis
 10: US 29 & Dickerson Road

05/31/2021

												
Movement	EBL	EBT	EBR	WBL	WBT	WBR	NBL	NBT	NBR	SBL	SBT	SBR
Lane Configurations												
Traffic Volume (veh/h)	10	0	15	1	0	0	11	601	0	2	2118	16
Future Volume (Veh/h)	10	0	15	1	0	0	11	601	0	2	2118	16
Sign Control		Stop			Stop			Free			Free	
Grade		0%			0%			0%			0%	
Peak Hour Factor	0.96	0.96	0.96	0.96	0.96	0.96	0.96	0.96	0.96	0.96	0.96	0.96
Hourly flow rate (vph)	10	0	16	1	0	0	11	626	0	2	2206	17
Pedestrians												
Lane Width (ft)												
Walking Speed (ft/s)												
Percent Blockage												
Right turn flare (veh)												
Median type												
Median storage (veh)												
Upstream signal (ft)												
pX, platoon unblocked												
vC, conflicting volume	2545	2858	1103	1771	2875	313	2223			626		
vC1, stage 1 conf vol	2210	2210		648	648							
vC2, stage 2 conf vol	335	648		1123	2227							
vCu, unblocked vol	2545	2858	1103	1771	2875	313	2223			626		
tC, single (s)	7.5	6.5	7.0	7.5	6.5	6.9	4.6			4.1		
tC, 2 stage (s)	6.5	5.5		6.5	5.5							
tF (s)	3.5	4.0	3.4	3.5	4.0	3.3	2.5			2.2		
p0 queue free %	78	100	92	99	100	100	93			100		
cM capacity (veh/h)	45	79	198	173	67	689	162			965		
Direction, Lane #	EB 1	WB 1	NB 1	NB 2	NB 3	SB 1	SB 2	SB 3	SB 4			
Volume Total	26	1	11	417	209	2	1103	1103	17			
Volume Left	10	1	11	0	0	2	0	0	0			
Volume Right	16	0	0	0	0	0	0	0	17			
cSH	86	173	162	1700	1700	965	1700	1700	1700			
Volume to Capacity	0.30	0.01	0.07	0.25	0.12	0.00	0.65	0.65	0.01			
Queue Length 95th (ft)	28	0	5	0	0	0	0	0	0			
Control Delay (s)	64.3	25.9	28.9	0.0	0.0	8.7	0.0	0.0	0.0			
Lane LOS	F	D	D			A						
Approach Delay (s)	64.3	25.9	0.5			0.0						
Approach LOS	F	D										
Intersection Summary												
Average Delay			0.7									
Intersection Capacity Utilization			68.5%	ICU Level of Service	C							
Analysis Period (min)			15									

Queues

11: US 29 & Austin Drive

05/31/2021



Lane Group	EBL	EBT	NBL	NBT	SBT	SBR
Lane Group Flow (vph)	2	30	16	567	2149	9
v/c Ratio	0.02	0.24	0.15	0.20	0.74	0.01
Control Delay	48.0	23.2	51.4	2.1	11.9	0.0
Queue Delay	0.0	0.0	0.0	0.0	0.0	0.0
Total Delay	48.0	23.2	51.4	2.1	11.9	0.0
Queue Length 50th (ft)	1	1	11	38	315	0
Queue Length 95th (ft)	9	31	34	56	#925	0
Internal Link Dist (ft)		306		669	657	
Turn Bay Length (ft)			500			350
Base Capacity (vph)	126	131	183	2862	2888	1161
Starvation Cap Reductn	0	0	0	0	0	0
Spillback Cap Reductn	0	0	0	0	0	0
Storage Cap Reductn	0	0	0	0	0	0
Reduced v/c Ratio	0.02	0.23	0.09	0.20	0.74	0.01



















Intersection Summary

95th percentile volume exceeds capacity, queue may be longer.
 Queue shown is maximum after two cycles.

HCM Signalized Intersection Capacity Analysis

11: US 29 & Austin Drive

05/31/2021

												
Movement	EBL	EBT	EBR	WBL	WBT	WBR	NBL	NBT	NBR	SBL	SBT	SBR
Lane Configurations												
Traffic Volume (vph)	2	2	27	0	0	0	15	539	0	0	2042	9
Future Volume (vph)	2	2	27	0	0	0	15	539	0	0	2042	9
Ideal Flow (vphpl)	1900	1900	1900	1900	1900	1900	1900	1900	1900	1900	1900	1900
Total Lost time (s)	7.5	7.5					7.5	7.0			7.0	7.0
Lane Util. Factor	1.00	1.00					1.00	0.95			0.95	1.00
Frt	1.00	0.86					1.00	1.00			1.00	0.85
Flt Protected	0.95	1.00					0.95	1.00			1.00	1.00
Satd. Flow (prot)	1805	1495					1612	3252			3505	1369
Flt Permitted	0.95	1.00					0.95	1.00			1.00	1.00
Satd. Flow (perm)	1805	1495					1612	3252			3505	1369
Peak-hour factor, PHF	0.95	0.95	0.95	0.95	0.95	0.95	0.95	0.95	0.95	0.95	0.95	0.95
Adj. Flow (vph)	2	2	28	0	0	0	16	567	0	0	2149	9
RTOR Reduction (vph)	0	27	0	0	0	0	0	0	0	0	0	2
Lane Group Flow (vph)	2	3	0	0	0	0	16	567	0	0	2149	7
Heavy Vehicles (%)	0%	0%	10%	0%	0%	0%	12%	11%	0%	0%	3%	18%
Turn Type	Split	NA					Prot	NA			NA	Prot
Protected Phases	4	4			3		5	2			6	6
Permitted Phases				3						6		
Actuated Green, G (s)	4.5	4.5					3.1	91.0			80.4	80.4
Effective Green, g (s)	4.5	4.5					3.1	91.0			80.4	80.4
Actuated g/C Ratio	0.04	0.04					0.03	0.83			0.73	0.73
Clearance Time (s)	7.5	7.5					7.5	7.0			7.0	7.0
Vehicle Extension (s)	3.0	3.0					3.0	3.0			3.0	3.0
Lane Grp Cap (vph)	73	61					45	2690			2561	1000
v/s Ratio Prot	0.00	c0.00					0.01	c0.17			c0.61	0.00
v/s Ratio Perm												
v/c Ratio	0.03	0.05					0.36	0.21			0.84	0.01
Uniform Delay, d1	50.6	50.7					52.5	2.0			10.3	4.0
Progression Factor	1.00	1.00					1.00	1.00			1.00	1.00
Incremental Delay, d2	0.2	0.4					4.8	0.2			3.5	0.0
Delay (s)	50.8	51.1					57.2	2.2			13.8	4.0
Level of Service	D	D					E	A			B	A
Approach Delay (s)		51.0			0.0			3.7			13.8	
Approach LOS		D			A			A			B	
Intersection Summary												
HCM 2000 Control Delay			12.1				HCM 2000 Level of Service				B	
HCM 2000 Volume to Capacity ratio			0.86									
Actuated Cycle Length (s)			110.0				Sum of lost time (s)			29.0		
Intersection Capacity Utilization			74.4%				ICU Level of Service			D		
Analysis Period (min)			15									
c Critical Lane Group												

Queues

12: US 29 & Boulders Road

05/31/2021

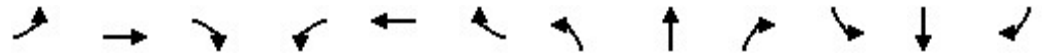

Lane Group	EBL	EBT	EBR	WBL	WBT	WBR	NBL	NBT	NBR	SBL	SBT	SBR
Lane Group Flow (vph)	13	28	111	9	9	13	41	553	182	110	2038	56
v/c Ratio	0.13	0.13	0.44	0.08	0.08	0.05	0.31	0.29	0.17	0.39	0.89	0.05
Control Delay	51.2	49.6	7.4	50.1	50.1	0.3	53.7	12.5	2.4	51.5	26.2	0.1
Queue Delay	0.0	0.0	0.0	0.0	0.0	0.0	0.0	0.0	0.0	0.0	0.0	0.0
Total Delay	51.2	49.6	7.4	50.1	50.1	0.3	53.7	12.5	2.4	51.5	26.2	0.1
Queue Length 50th (ft)	9	10	0	6	6	0	28	105	0	38	~817	0
Queue Length 95th (ft)	31	26	17	24	24	0	62	153	33	65	#1009	0
Internal Link Dist (ft)		179			369			731			699	
Turn Bay Length (ft)			175			350	400		300	550		425
Base Capacity (vph)	186	400	329	204	205	336	224	1931	1040	299	2282	1120
Starvation Cap Reductn	0	0	0	0	0	0	0	0	0	0	0	0
Spillback Cap Reductn	0	0	0	0	0	0	0	0	0	0	0	0
Storage Cap Reductn	0	0	0	0	0	0	0	0	0	0	0	0
Reduced v/c Ratio	0.07	0.07	0.34	0.04	0.04	0.04	0.18	0.29	0.17	0.37	0.89	0.05

























Intersection Summary

- ~ Volume exceeds capacity, queue is theoretically infinite.
Queue shown is maximum after two cycles.
- # 95th percentile volume exceeds capacity, queue may be longer.
Queue shown is maximum after two cycles.

HCM Signalized Intersection Capacity Analysis





















12: US 29 & Boulders Road

05/31/2021

														
Movement	EBL	EBT	EBR	WBL	WBT	WBR	NBL	NBT	NBR	SBL	SBT	SBR		
Lane Configurations														
Traffic Volume (vph)	20	19	104	16	1	12	39	520	171	103	1916	53		
Future Volume (vph)	20	19	104	16	1	12	39	520	171	103	1916	53		
Ideal Flow (vphpl)	1900	1900	1900	1900	1900	1900	1900	1900	1900	1900	1900	1900		
Total Lost time (s)	6.9	6.9	6.9	6.9	6.9	6.9	5.9	6.2	6.2	6.4	6.0	6.0		
Lane Util. Factor	0.91	0.91	1.00	0.95	0.95	1.00	1.00	0.95	1.00	0.97	0.95	1.00		
Frt	1.00	1.00	0.85	1.00	1.00	0.85	1.00	1.00	0.85	1.00	1.00	0.85		
Flt Protected	0.95	0.99	1.00	0.95	0.96	1.00	0.95	1.00	1.00	0.95	1.00	1.00		
Satd. Flow (prot)	1564	3361	1553	1715	1728	1615	1752	3223	1615	3502	3471	1615		
Flt Permitted	0.95	0.99	1.00	0.95	0.96	1.00	0.95	1.00	1.00	0.95	1.00	1.00		
Satd. Flow (perm)	1564	3361	1553	1715	1728	1615	1752	3223	1615	3502	3471	1615		
Peak-hour factor, PHF	0.94	0.94	0.94	0.94	0.94	0.94	0.94	0.94	0.94	0.94	0.94	0.94		
Adj. Flow (vph)	21	20	111	17	1	13	41	553	182	110	2038	56		
RTOR Reduction (vph)	0	0	104	0	0	12	0	0	77	0	0	22		
Lane Group Flow (vph)	13	28	7	9	9	1	41	553	105	110	2038	34		
Heavy Vehicles (%)	5%	0%	4%	0%	0%	0%	3%	12%	0%	0%	4%	0%		
Turn Type	Split	NA	Prot	Split	NA	Prot	Prot	NA	Prot	Prot	NA	Prot		
Protected Phases	4	4	4	3	3	3	5	2	2	1	6	6		
Permitted Phases														
Actuated Green, G (s)	7.2	7.2	7.2	4.3	4.3	4.3	5.6	63.2	63.2	8.9	67.2	67.2		
Effective Green, g (s)	7.2	7.2	7.2	4.3	4.3	4.3	5.6	63.2	63.2	8.9	67.2	67.2		
Actuated g/C Ratio	0.07	0.07	0.07	0.04	0.04	0.04	0.05	0.57	0.57	0.08	0.61	0.61		
Clearance Time (s)	6.9	6.9	6.9	6.9	6.9	6.9	5.9	6.2	6.2	6.4	6.0	6.0		
Vehicle Extension (s)	3.0	3.0	3.0	3.0	3.0	3.0	3.0	3.0	3.0	3.0	3.0	3.0		
Lane Grp Cap (vph)	102	219	101	67	67	63	89	1851	927	283	2120	986		
v/s Ratio Prot	0.01	c0.01	0.00	c0.01	0.01	0.00	0.02	0.17	0.06	c0.03	c0.59	0.02		
v/s Ratio Perm														
v/c Ratio	0.13	0.13	0.07	0.13	0.13	0.01	0.46	0.30	0.11	0.39	0.96	0.03		
Uniform Delay, d1	48.4	48.4	48.3	51.1	51.1	50.8	50.7	12.0	10.6	48.0	20.2	8.5		
Progression Factor	1.00	1.00	1.00	1.00	1.00	1.00	1.00	1.00	1.00	1.00	1.00	1.00		
Incremental Delay, d2	0.6	0.3	0.3	0.9	0.9	0.1	3.7	0.4	0.2	0.9	12.3	0.1		
Delay (s)	49.0	48.7	48.6	52.0	52.0	50.9	54.5	12.4	10.9	48.9	32.5	8.6		
Level of Service	D	D	D	D	D	D	D	B	B	D	C	A		
Approach Delay (s)		48.6			51.5			14.3			32.7			
Approach LOS		D			D			B			C			
Intersection Summary														
HCM 2000 Control Delay			29.2									HCM 2000 Level of Service	C	
HCM 2000 Volume to Capacity ratio			0.83											
Actuated Cycle Length (s)			110.0								26.4			
Intersection Capacity Utilization			81.7%										ICU Level of Service	D
Analysis Period (min)			15											
c Critical Lane Group														

HCM Unsignalized Intersection Capacity Analysis
 13: US 29 & Camelot Drive

05/31/2021

													
Movement	EBL	EBT	EBR	WBL	WBT	WBR	NBL	NBT	NBR	SBL	SBT	SBR	
Lane Configurations													
Traffic Volume (veh/h)	6	0	41	5	0	2	23	851	7	3	2118	5	
Future Volume (Veh/h)	6	0	41	5	0	2	23	851	7	3	2118	5	
Sign Control		Stop			Stop			Free			Free		
Grade		0%			0%			0%			0%		
Peak Hour Factor	0.95	0.95	0.95	0.95	0.95	0.95	0.95	0.95	0.95	0.95	0.95	0.95	
Hourly flow rate (vph)	6	0	43	5	0	2	24	896	7	3	2229	5	
Pedestrians													
Lane Width (ft)													
Walking Speed (ft/s)													
Percent Blockage													
Right turn flare (veh)													
Median type													
Median storage (veh)													
Upstream signal (ft)													
pX, platoon unblocked													
vC, conflicting volume	2733	3186	1114	2108	3184	448	2234			903			
vC1, stage 1 conf vol	2235	2235		944	944								
vC2, stage 2 conf vol	498	951		1164	2240								
vCu, unblocked vol	2733	3186	1114	2108	3184	448	2234			903			
tC, single (s)	7.8	6.5	7.0	7.5	6.5	6.9	4.2			4.1			
tC, 2 stage (s)	6.8	5.5		6.5	5.5								
tF (s)	3.6	4.0	3.4	3.5	4.0	3.3	2.2			2.2			
p0 queue free %	83	100	78	96	100	100	89			100			
cM capacity (veh/h)	36	75	195	119	53	564	219			761			
Direction, Lane #	EB 1	WB 1	NB 1	NB 2	NB 3	NB 4	SB 1	SB 2	SB 3	SB 4			
Volume Total	49	7	24	448	448	7	3	1114	1114	5			
Volume Left	6	5	24	0	0	0	3	0	0	0			
Volume Right	43	2	0	0	0	7	0	0	0	5			
cSH	126	154	219	1700	1700	1700	761	1700	1700	1700			
Volume to Capacity	0.39	0.05	0.11	0.26	0.26	0.00	0.00	0.66	0.66	0.00			
Queue Length 95th (ft)	41	4	9	0	0	0	0	0	0	0			
Control Delay (s)	50.5	29.5	23.4	0.0	0.0	0.0	9.7	0.0	0.0	0.0			
Lane LOS	F	D	C				A						
Approach Delay (s)	50.5	29.5	0.6				0.0						
Approach LOS	F	D											
Intersection Summary													
Average Delay			1.0										
Intersection Capacity Utilization			68.5%	ICU Level of Service						C			
Analysis Period (min)			15										

Queues

14: US 29 & Lewis and Clark Drive

05/31/2021



Lane Group	EBL	EBR	NBL	NBT	SBT	SBR
Lane Group Flow (vph)	21	7	56	938	2072	156
v/c Ratio	0.16	0.06	0.37	0.32	0.78	0.12
Control Delay	50.4	27.6	53.5	2.1	14.9	1.4
Queue Delay	0.0	0.0	0.0	0.0	0.0	0.0
Total Delay	50.4	27.6	53.5	2.1	14.9	1.4
Queue Length 50th (ft)	14	0	38	66	551	0
Queue Length 95th (ft)	40	15	77	90	#815	23
Internal Link Dist (ft)	654			696	637	
Turn Bay Length (ft)			450			375
Base Capacity (vph)	147	122	241	2972	2640	1253
Starvation Cap Reductn	0	0	0	0	0	0
Spillback Cap Reductn	0	0	0	0	0	0
Storage Cap Reductn	0	0	0	0	0	0
Reduced v/c Ratio	0.14	0.06	0.23	0.32	0.78	0.12

Intersection Summary

95th percentile volume exceeds capacity, queue may be longer.
 Queue shown is maximum after two cycles.

HCM Signalized Intersection Capacity Analysis

14: US 29 & Lewis and Clark Drive

05/31/2021



Movement	EBL	EBR	NBL	NBT	SBU	SBT	SBR
Lane Configurations							
Traffic Volume (vph)	20	7	53	891	0	1968	148
Future Volume (vph)	20	7	53	891	0	1968	148
Ideal Flow (vphpl)	1900	1900	1900	1900	1900	1900	1900
Total Lost time (s)	6.0	6.0	6.0	6.0		6.0	6.0
Lane Util. Factor	1.00	1.00	1.00	0.95		0.95	1.00
Frt	1.00	0.85	1.00	1.00		1.00	0.85
Flt Protected	0.95	1.00	0.95	1.00		1.00	1.00
Satd. Flow (prot)	1805	1417	1770	3343		3471	1599
Flt Permitted	0.95	1.00	0.95	1.00		1.00	1.00
Satd. Flow (perm)	1805	1417	1770	3343		3471	1599
Peak-hour factor, PHF	0.95	0.95	0.95	0.95	0.92	0.95	0.95
Adj. Flow (vph)	21	7	56	938	0	2072	156
RTOR Reduction (vph)	0	7	0	0	0	0	44
Lane Group Flow (vph)	21	0	56	938	0	2072	112
Heavy Vehicles (%)	0%	14%	2%	8%	2%	4%	1%
Turn Type	Prot	Prot	Prot	NA	Prot	NA	Prot
Protected Phases	4	4	5	2	1	6	6
Permitted Phases							
Actuated Green, G (s)	5.0	5.0	8.1	93.0		78.9	78.9
Effective Green, g (s)	5.0	5.0	8.1	93.0		78.9	78.9
Actuated g/C Ratio	0.05	0.05	0.07	0.85		0.72	0.72
Clearance Time (s)	6.0	6.0	6.0	6.0		6.0	6.0
Vehicle Extension (s)	3.5	3.5	3.5	4.0		4.0	4.0
Lane Grp Cap (vph)	82	64	130	2826		2489	1146
v/s Ratio Prot	c0.01	0.00	0.03	c0.28		c0.60	0.07
v/s Ratio Perm							
v/c Ratio	0.26	0.00	0.43	0.33		0.83	0.10
Uniform Delay, d1	50.7	50.1	48.7	1.8		10.9	4.7
Progression Factor	1.00	1.00	1.00	1.00		1.00	1.00
Incremental Delay, d2	2.0	0.0	2.7	0.3		3.4	0.2
Delay (s)	52.7	50.2	51.4	2.1		14.3	4.9
Level of Service	D	D	D	A		B	A
Approach Delay (s)	52.0			4.9		13.7	
Approach LOS	D			A		B	

Intersection Summary

HCM 2000 Control Delay	11.3	HCM 2000 Level of Service	B
HCM 2000 Volume to Capacity ratio	0.77		
Actuated Cycle Length (s)	110.0	Sum of lost time (s)	18.0
Intersection Capacity Utilization	71.1%	ICU Level of Service	C
Analysis Period (min)	15		
c Critical Lane Group			

HCM Unsignalized Intersection Capacity Analysis
 15: US 29 (S) & U-Turn Access

05/31/2021



Movement	WBL	WBR	NBT	NBR	SBL	SBT
Lane Configurations	↰					↱↱
Traffic Volume (veh/h)	15	0	0	0	0	1976
Future Volume (Veh/h)	15	0	0	0	0	1976
Sign Control	Stop		Free			Free
Grade	0%		0%			0%
Peak Hour Factor	0.92	0.92	0.92	0.92	0.92	0.92
Hourly flow rate (vph)	16	0	0	0	0	2148
Pedestrians						
Lane Width (ft)						
Walking Speed (ft/s)						
Percent Blockage						
Right turn flare (veh)						
Median type			None			None
Median storage (veh)						
Upstream signal (ft)						
pX, platoon unblocked						
vC, conflicting volume	1074	0			0	
vC1, stage 1 conf vol						
vC2, stage 2 conf vol						
vCu, unblocked vol	1074	0			0	
tC, single (s)	6.8	6.9			4.1	
tC, 2 stage (s)						
tF (s)	3.5	3.3			2.2	
p0 queue free %	93	100			100	
cM capacity (veh/h)	215	1084			1622	
Direction, Lane #	WB 1	SB 1	SB 2			
Volume Total	16	1074	1074			
Volume Left	16	0	0			
Volume Right	0	0	0			
cSH	215	1700	1700			
Volume to Capacity	0.07	0.63	0.63			
Queue Length 95th (ft)	6	0	0			
Control Delay (s)	23.1	0.0	0.0			
Lane LOS	C					
Approach Delay (s)	23.1	0.0				
Approach LOS	C					
Intersection Summary						
Average Delay			0.2			
Intersection Capacity Utilization			86.8%		ICU Level of Service	E
Analysis Period (min)			15			

HCM Unsignalized Intersection Capacity Analysis
 16: US 29 (N) & U-Turn Access

05/31/2021



Movement	EBL	EBR	NBL	NBT	SBT	SBR
Lane Configurations						
Traffic Volume (veh/h)	0	0	15	922	0	0
Future Volume (Veh/h)	0	0	15	922	0	0
Sign Control	Stop			Free	Free	
Grade	0%			0%	0%	
Peak Hour Factor	0.92	0.92	0.92	0.92	0.92	0.92
Hourly flow rate (vph)	0	0	16	1002	0	0
Pedestrians						
Lane Width (ft)						
Walking Speed (ft/s)						
Percent Blockage						
Right turn flare (veh)						
Median type				None	None	
Median storage (veh)						
Upstream signal (ft)						
pX, platoon unblocked						
vC, conflicting volume	533	0	0			
vC1, stage 1 conf vol						
vC2, stage 2 conf vol						
vCu, unblocked vol	533	0	0			
tC, single (s)	6.8	6.9	4.1			
tC, 2 stage (s)						
tF (s)	3.5	3.3	2.2			
p0 queue free %	100	100	99			
cM capacity (veh/h)	472	1084	1622			
Direction, Lane #	NB 1	NB 2	NB 3			
Volume Total	16	501	501			
Volume Left	16	0	0			
Volume Right	0	0	0			
cSH	1622	1700	1700			
Volume to Capacity	0.01	0.29	0.29			
Queue Length 95th (ft)	1	0	0			
Control Delay (s)	7.2	0.0	0.0			
Lane LOS	A					
Approach Delay (s)	0.1					
Approach LOS						
Intersection Summary						
Average Delay	0.1					
Intersection Capacity Utilization	86.8%			ICU Level of Service	E	
Analysis Period (min)	15					

HCM Unsignalized Intersection Capacity Analysis
 17: Northside Dr E & US 29 (S)

















05/31/2021



Movement	WBL	WBR	NBT	NBR	SBL	SBT
Lane Configurations					↘	↕↕
Traffic Volume (veh/h)	0	0	0	0	13	2057
Future Volume (Veh/h)	0	0	0	0	13	2057
Sign Control	Stop		Free		Free	
Grade	0%		0%		0%	
Peak Hour Factor	0.92	0.92	0.92	0.92	0.92	0.92
Hourly flow rate (vph)	0	0	0	0	14	2236
Pedestrians						
Lane Width (ft)						
Walking Speed (ft/s)						
Percent Blockage						
Right turn flare (veh)						
Median type	None			None		
Median storage (veh)						
Upstream signal (ft)						
pX, platoon unblocked						
vC, conflicting volume	1146	0			0	
vC1, stage 1 conf vol						
vC2, stage 2 conf vol						
vCu, unblocked vol	1146	0			0	
tC, single (s)	6.8	6.9			4.1	
tC, 2 stage (s)						
tF (s)	3.5	3.3			2.2	
p0 queue free %	100	100			99	
cM capacity (veh/h)	191	1084			1622	
Direction, Lane #	SB 1	SB 2	SB 3			
Volume Total	14	1118	1118			
Volume Left	14	0	0			
Volume Right	0	0	0			
cSH	1622	1700	1700			
Volume to Capacity	0.01	0.66	0.66			
Queue Length 95th (ft)	1	0	0			
Control Delay (s)	7.2	0.0	0.0			
Lane LOS	A					
Approach Delay (s)	0.0					
Approach LOS						
Intersection Summary						
Average Delay	0.0					
Intersection Capacity Utilization	64.6%		ICU Level of Service		C	
Analysis Period (min)	15					

















HCM Unsignalized Intersection Capacity Analysis
 18: US 29 (N) & Northside Dr E

05/31/2021

												
Movement	EBL	EBT	EBR	WBL	WBT	WBR	NBL	NBT	NBR	SBL	SBT	SBR
Lane Configurations								 				
Traffic Volume (veh/h)	0	13	0	0	0	1	0	937	3	0	0	0
Future Volume (Veh/h)	0	13	0	0	0	1	0	937	3	0	0	0
Sign Control		Stop			Stop			Free			Free	
Grade		0%			0%			0%			0%	
Peak Hour Factor	0.92	0.92	0.92	0.92	0.92	0.92	0.92	0.92	0.92	0.92	0.92	0.92
Hourly flow rate (vph)	0	14	0	0	0	1	0	1018	3	0	0	0
Pedestrians												
Lane Width (ft)												
Walking Speed (ft/s)												
Percent Blockage												
Right turn flare (veh)												
Median type								None			None	
Median storage (veh)												
Upstream signal (ft)												
pX, platoon unblocked												
vC, conflicting volume	510	1021	0	1025	1018	509	0			1021		
vC1, stage 1 conf vol												
vC2, stage 2 conf vol												
vCu, unblocked vol	510	1021	0	1025	1018	509	0			1021		
tC, single (s)	7.5	6.5	6.9	7.5	6.5	6.9	4.1			4.1		
tC, 2 stage (s)												
tF (s)	3.5	4.0	3.3	3.5	4.0	3.3	2.2			2.2		
p0 queue free %	100	94	100	100	100	100	100			100		
cM capacity (veh/h)	445	235	1084	181	236	509	1622			675		
Direction, Lane #	EB 1	WB 1	NB 1	NB 2	NB 3							
Volume Total	14	1	509	509	3							
Volume Left	0	0	0	0	0							
Volume Right	0	1	0	0	3							
cSH	235	509	1700	1700	1700							
Volume to Capacity	0.06	0.00	0.30	0.30	0.00							
Queue Length 95th (ft)	5	0	0	0	0							
Control Delay (s)	21.3	12.1	0.0	0.0	0.0							
Lane LOS	C	B										
Approach Delay (s)	21.3	12.1	0.0									
Approach LOS	C	B										
Intersection Summary												
Average Delay			0.3									
Intersection Capacity Utilization			94.1%		ICU Level of Service				F			
Analysis Period (min)			15									

HCM Unsignalized Intersection Capacity Analysis
 19: US 29 (S) & Northside Dr W

05/31/2021

												
Movement	EBL	EBT	EBR	WBL	WBT	WBR	NBL	NBT	NBR	SBL	SBT	SBR
Lane Configurations												
Traffic Volume (veh/h)	0	0	10	0	4	0	0	0	0	0	2048	9
Future Volume (Veh/h)	0	0	10	0	4	0	0	0	0	0	2048	9
Sign Control		Stop			Stop			Free			Free	
Grade		0%			0%			0%			0%	
Peak Hour Factor	0.92	0.92	0.92	0.92	0.92	0.92	0.92	0.92	0.92	0.92	0.92	0.92
Hourly flow rate (vph)	0	0	11	0	4	0	0	0	0	0	2226	10
Pedestrians												
Lane Width (ft)												
Walking Speed (ft/s)												
Percent Blockage												
Right turn flare (veh)												
Median type												
								None			None	
Median storage (veh)												
Upstream signal (ft)												
pX, platoon unblocked												
vC, conflicting volume	2228	2226	1113	1124	2236	0	2236			0		
vC1, stage 1 conf vol												
vC2, stage 2 conf vol												
vCu, unblocked vol	2228	2226	1113	1124	2236	0	2236			0		
tC, single (s)	7.5	6.5	6.9	7.5	6.5	6.9	4.1			4.1		
tC, 2 stage (s)												
tF (s)	3.5	4.0	3.3	3.5	4.0	3.3	2.2			2.2		
p0 queue free %	100	100	95	100	90	100	100			100		
cM capacity (veh/h)	22	43	203	151	42	1084	228			1622		
Direction, Lane #	EB 1	WB 1	SB 1	SB 2	SB 3							
Volume Total	11	4	1113	1113	10							
Volume Left	0	0	0	0	0							
Volume Right	11	0	0	0	10							
cSH	203	42	1700	1700	1700							
Volume to Capacity	0.05	0.10	0.65	0.65	0.01							
Queue Length 95th (ft)	4	7	0	0	0							
Control Delay (s)	23.8	99.7	0.0	0.0	0.0							
Lane LOS	C	F										
Approach Delay (s)	23.8	99.7	0.0									
Approach LOS	C	F										
Intersection Summary												
Average Delay			0.3									
Intersection Capacity Utilization			66.6%		ICU Level of Service					C		
Analysis Period (min)			15									

HCM Unsignalized Intersection Capacity Analysis

20: US 29 (N) & Northside Dr W

05/31/2021



Movement	EBL	EBR	NBL	NBT	SBT	SBR
Lane Configurations						
Traffic Volume (veh/h)	0	0	4	940	0	0
Future Volume (Veh/h)	0	0	4	940	0	0
Sign Control	Stop			Free	Free	
Grade	0%			0%	0%	
Peak Hour Factor	0.92	0.92	0.92	0.92	0.92	0.92
Hourly flow rate (vph)	0	0	4	1022	0	0
Pedestrians						
Lane Width (ft)						
Walking Speed (ft/s)						
Percent Blockage						
Right turn flare (veh)						
Median type				None	None	
Median storage (veh)						
Upstream signal (ft)						
pX, platoon unblocked						
vC, conflicting volume	519	0	0			
vC1, stage 1 conf vol						
vC2, stage 2 conf vol						
vCu, unblocked vol	519	0	0			
tC, single (s)	6.8	6.9	4.1			
tC, 2 stage (s)						
tF (s)	3.5	3.3	2.2			
p0 queue free %	100	100	100			
cM capacity (veh/h)	485	1084	1622			
Direction, Lane #	NB 1	NB 2	NB 3			
Volume Total	4	511	511			
Volume Left	4	0	0			
Volume Right	0	0	0			
cSH	1622	1700	1700			
Volume to Capacity	0.00	0.30	0.30			
Queue Length 95th (ft)	0	0	0			
Control Delay (s)	7.2	0.0	0.0			
Lane LOS	A					
Approach Delay (s)	0.0					
Approach LOS						
Intersection Summary						
Average Delay	0.0					
Intersection Capacity Utilization	66.6%			ICU Level of Service	C	
Analysis Period (min)	15					

HCM Unsignalized Intersection Capacity Analysis
 21: Airport Acres Rd (North) E & US 29 (S)

05/31/2021



Movement	WBL	WBR	NBT	NBR	SBL	SBT
Lane Configurations					↘	↕↕
Traffic Volume (veh/h)	0	0	0	0	1	2083
Future Volume (Veh/h)	0	0	0	0	1	2083
Sign Control	Stop		Free			Free
Grade	0%		0%			0%
Peak Hour Factor	0.92	0.92	0.92	0.92	0.92	0.92
Hourly flow rate (vph)	0	0	0	0	1	2264
Pedestrians						
Lane Width (ft)						
Walking Speed (ft/s)						
Percent Blockage						
Right turn flare (veh)						
Median type	None			None		
Median storage (veh)						
Upstream signal (ft)						
pX, platoon unblocked						
vC, conflicting volume	1134	0			0	
vC1, stage 1 conf vol						
vC2, stage 2 conf vol						
vCu, unblocked vol	1134	0			0	
tC, single (s)	6.8	6.9			4.1	
tC, 2 stage (s)						
tF (s)	3.5	3.3			2.2	
p0 queue free %	100	100			100	
cM capacity (veh/h)	196	1084			1622	
Direction, Lane #	SB 1	SB 2	SB 3			
Volume Total	1	1132	1132			
Volume Left	1	0	0			
Volume Right	0	0	0			
cSH	1622	1700	1700			
Volume to Capacity	0.00	0.67	0.67			
Queue Length 95th (ft)	0	0	0			
Control Delay (s)	7.2	0.0	0.0			
Lane LOS	A					
Approach Delay (s)	0.0					
Approach LOS						
Intersection Summary						
Average Delay	0.0					
Intersection Capacity Utilization	60.9%		ICU Level of Service		B	
Analysis Period (min)	15					

HCM Unsignalized Intersection Capacity Analysis
 22: Airport Acres Rd (North) E & US 29 (N)

05/31/2021



Movement	EBL	EBR	NBL	NBT	SBT	SBR
Lane Configurations	↙			↕		
Traffic Volume (veh/h)	1	0	0	918	0	0
Future Volume (Veh/h)	1	0	0	918	0	0
Sign Control	Stop			Free	Free	
Grade	0%			0%	0%	
Peak Hour Factor	0.92	0.92	0.92	0.92	0.92	0.92
Hourly flow rate (vph)	1	0	0	998	0	0
Pedestrians						
Lane Width (ft)						
Walking Speed (ft/s)						
Percent Blockage						
Right turn flare (veh)						
Median type				None	None	
Median storage (veh)						
Upstream signal (ft)						
pX, platoon unblocked						
vC, conflicting volume	499	0	0			
vC1, stage 1 conf vol						
vC2, stage 2 conf vol						
vCu, unblocked vol	499	0	0			
tC, single (s)	6.8	6.9	4.1			
tC, 2 stage (s)						
tF (s)	3.5	3.3	2.2			
p0 queue free %	100	100	100			
cM capacity (veh/h)	501	1084	1622			
Direction, Lane #	EB 1	NB 1	NB 2			
Volume Total	1	499	499			
Volume Left	1	0	0			
Volume Right	0	0	0			
cSH	501	1700	1700			
Volume to Capacity	0.00	0.29	0.29			
Queue Length 95th (ft)	0	0	0			
Control Delay (s)	12.2	0.0	0.0			
Lane LOS	B					
Approach Delay (s)	12.2	0.0				
Approach LOS	B					
Intersection Summary						
Average Delay			0.0			
Intersection Capacity Utilization			35.4%	ICU Level of Service	A	
Analysis Period (min)			15			

HCM Unsignalized Intersection Capacity Analysis
 23: US 29 (S) & Airport Acres Rd (North) W

05/31/2021



Movement	EBL	EBT	EBR	WBL	WBT	WBR	NBL	NBT	NBR	SBL	SBT	SBR
Lane Configurations			↗		↖						↕	↗
Traffic Volume (veh/h)	0	0	3	0	1	0	0	0	0	0	2082	1
Future Volume (Veh/h)	0	0	3	0	1	0	0	0	0	0	2082	1
Sign Control		Stop			Stop			Free			Free	
Grade		0%			0%			0%			0%	
Peak Hour Factor	0.92	0.92	0.92	0.92	0.92	0.92	0.92	0.92	0.92	0.92	0.92	0.92
Hourly flow rate (vph)	0	0	3	0	1	0	0	0	0	0	2263	1
Pedestrians												
Lane Width (ft)												
Walking Speed (ft/s)												
Percent Blockage												
Right turn flare (veh)												
Median type								None			None	
Median storage (veh)												
Upstream signal (ft)												
pX, platoon unblocked												
vC, conflicting volume	2264	2264	1132	1134	2264	0	2264			0		
vC1, stage 1 conf vol												
vC2, stage 2 conf vol												
vCu, unblocked vol	2264	2264	1132	1134	2264	0	2264			0		
tC, single (s)	7.5	6.5	6.9	7.5	6.5	6.9	4.1			4.1		
tC, 2 stage (s)												
tF (s)	3.5	4.0	3.3	3.5	4.0	3.3	2.2			2.2		
p0 queue free %	100	100	98	100	98	100	100			100		
cM capacity (veh/h)	22	40	197	155	40	1084	223			1622		
Direction, Lane #	EB 1	WB 1	SB 1	SB 2								
Volume Total	3	1	1509	755								
Volume Left	0	0	0	0								
Volume Right	3	0	0	1								
cSH	197	40	1700	1700								
Volume to Capacity	0.02	0.02	0.89	0.44								
Queue Length 95th (ft)	1	2	0	0								
Control Delay (s)	23.6	96.7	0.0	0.0								
Lane LOS	C	F										
Approach Delay (s)	23.6	96.7	0.0									
Approach LOS	C	F										
Intersection Summary												
Average Delay			0.1									
Intersection Capacity Utilization			67.6%		ICU Level of Service					C		
Analysis Period (min)			15									

HCM Unsignalized Intersection Capacity Analysis

24: US 29 (N)

05/31/2021



Movement	EBL	EBR	NBL	NBT	SBT	SBR
Lane Configurations			↙	↕		
Traffic Volume (veh/h)	0	0	1	918	0	0
Future Volume (Veh/h)	0	0	1	918	0	0
Sign Control	Stop			Free	Free	
Grade	0%			0%	0%	
Peak Hour Factor	0.92	0.92	0.92	0.92	0.92	0.92
Hourly flow rate (vph)	0	0	1	998	0	0
Pedestrians						
Lane Width (ft)						
Walking Speed (ft/s)						
Percent Blockage						
Right turn flare (veh)						
Median type				None	None	
Median storage (veh)						
Upstream signal (ft)						
pX, platoon unblocked						
vC, conflicting volume	501	0	0			
vC1, stage 1 conf vol						
vC2, stage 2 conf vol						
vCu, unblocked vol	501	0	0			
tC, single (s)	6.8	6.9	4.1			
tC, 2 stage (s)						
tF (s)	3.5	3.3	2.2			
p0 queue free %	100	100	100			
cM capacity (veh/h)	499	1084	1622			
Direction, Lane #	NB 1	NB 2	NB 3			
Volume Total	1	499	499			
Volume Left	1	0	0			
Volume Right	0	0	0			
cSH	1622	1700	1700			
Volume to Capacity	0.00	0.29	0.29			
Queue Length 95th (ft)	0	0	0			
Control Delay (s)	7.2	0.0	0.0			
Lane LOS	A					
Approach Delay (s)	0.0					
Approach LOS						
Intersection Summary						
Average Delay	0.0					
Intersection Capacity Utilization	67.6%			ICU Level of Service	C	
Analysis Period (min)	15					

HCM Unsignalized Intersection Capacity Analysis

25: US 29 & Airport Acres Rd South

05/31/2021



Movement	EBL	EBR	NBL	NBT	SBT	SBR
Lane Configurations						
Traffic Volume (veh/h)	2	5	15	888	2078	1
Future Volume (Veh/h)	2	5	15	888	2078	1
Sign Control	Stop			Free	Free	
Grade	0%			0%	0%	
Peak Hour Factor	0.93	0.93	0.93	0.93	0.93	0.93
Hourly flow rate (vph)	2	5	16	955	2234	1
Pedestrians						
Lane Width (ft)						
Walking Speed (ft/s)						
Percent Blockage						
Right turn flare (veh)						
Median type				Raised	Raised	
Median storage (veh)				2	2	
Upstream signal (ft)				872		
pX, platoon unblocked	0.85					
vC, conflicting volume	2744	1118	2235			
vC1, stage 1 conf vol	2234					
vC2, stage 2 conf vol	510					
vCu, unblocked vol	2698	1118	2235			
tC, single (s)	6.8	7.3	4.1			
tC, 2 stage (s)	5.8					
tF (s)	3.5	3.5	2.2			
p0 queue free %	97	97	93			
cM capacity (veh/h)	67	175	235			
Direction, Lane #	EB 1	NB 1	NB 2	NB 3	SB 1	SB 2
Volume Total	7	16	478	478	1489	746
Volume Left	2	16	0	0	0	0
Volume Right	5	0	0	0	0	1
cSH	120	235	1700	1700	1700	1700
Volume to Capacity	0.06	0.07	0.28	0.28	0.88	0.44
Queue Length 95th (ft)	5	5	0	0	0	0
Control Delay (s)	36.9	21.4	0.0	0.0	0.0	0.0
Lane LOS	E	C				
Approach Delay (s)	36.9	0.4	0.0			
Approach LOS	E					
Intersection Summary						
Average Delay			0.2			
Intersection Capacity Utilization			67.5%	ICU Level of Service	C	
Analysis Period (min)			15			

Queues

26: US 29 & Airport Road

05/31/2021



Lane Group	EBL	EBT	EBR	WBL	WBT	NBL	NBT	NBR	SBL	SBT	SBR
Lane Group Flow (vph)	96	63	83	112	190	161	782	111	206	1787	99
v/c Ratio	0.44	0.54	0.12	0.93	1.12	0.70	0.49	0.11	0.84	0.95	0.09
Control Delay	58.6	69.6	0.4	117.9	136.9	69.5	22.5	0.2	77.2	37.5	0.9
Queue Delay	0.0	0.0	0.0	0.0	0.0	0.0	0.0	0.0	0.0	0.0	0.0
Total Delay	58.6	69.6	0.4	117.9	136.9	69.5	22.5	0.2	77.2	37.5	0.9
Queue Length 50th (ft)	36	46	0	84	~118	61	207	0	150	629	0
Queue Length 95th (ft)	63	#98	0	#196	#267	#107	263	0	#272	#826	12
Internal Link Dist (ft)		677			627		911			792	
Turn Bay Length (ft)	425		450	570		575		430	475		540
Base Capacity (vph)	223	117	664	121	170	229	1585	1014	255	1880	1078
Starvation Cap Reductn	0	0	0	0	0	0	0	0	0	0	0
Spillback Cap Reductn	0	0	0	0	0	0	0	0	0	0	0
Storage Cap Reductn	0	0	0	0	0	0	0	0	0	0	0
Reduced v/c Ratio	0.43	0.54	0.13	0.93	1.12	0.70	0.49	0.11	0.81	0.95	0.09

Intersection Summary

~ Volume exceeds capacity, queue is theoretically infinite.























Queue shown is maximum after two cycles.

95th percentile volume exceeds capacity, queue may be longer.

Queue shown is maximum after two cycles.

HCM Signalized Intersection Capacity Analysis
 26: US 29 & Airport Road























05/31/2021

												
Movement	EBL	EBT	EBR	WBL	WBT	WBR	NBL	NBT	NBR	SBL	SBT	SBR
Lane Configurations												
Traffic Volume (vph)	90	59	78	105	62	117	151	735	104	194	1680	93
Future Volume (vph)	90	59	78	105	62	117	151	735	104	194	1680	93
Ideal Flow (vphp)	1900	1900	1900	1900	1900	1900	1900	1900	1900	1900	1900	1900
Total Lost time (s)	10.5	6.7	6.7	9.1	5.6		8.3	5.7	5.7	8.1	5.7	5.7
Lane Util. Factor	0.97	1.00	0.88	1.00	1.00		0.97	0.95	1.00	1.00	0.95	1.00
Frt	1.00	1.00	0.85	1.00	0.90		1.00	1.00	0.85	1.00	1.00	0.85
Flt Protected	0.95	1.00	1.00	0.95	1.00		0.95	1.00	1.00	0.95	1.00	1.00
Satd. Flow (prot)	3433	1845	2538	1770	1681		3433	3374	1524	1736	3471	1495
Flt Permitted	0.95	1.00	1.00	0.95	1.00		0.95	1.00	1.00	0.95	1.00	1.00
Satd. Flow (perm)	3433	1845	2538	1770	1681		3433	3374	1524	1736	3471	1495
Peak-hour factor, PHF	0.94	0.94	0.94	0.94	0.94	0.94	0.94	0.94	0.94	0.94	0.94	0.94
Adj. Flow (vph)	96	63	83	112	66	124	161	782	111	206	1787	99
RTOR Reduction (vph)	0	0	67	0	59	0	0	0	46	0	0	34
Lane Group Flow (vph)	96	63	16	112	131	0	161	782	65	206	1787	65
Heavy Vehicles (%)	2%	3%	12%	2%	0%	3%	2%	7%	6%	4%	4%	8%
Turn Type	Prot	NA	pt+ov	Prot	NA		Prot	NA	pt+ov	Prot	NA	pt+ov
Protected Phases	7	4	4 5	3	8		5	2	2 3	1	6	6 7
Permitted Phases												
Actuated Green, G (s)	7.3	7.3	21.7	7.9	7.6		7.7	54.0	67.6	16.2	62.3	75.3
Effective Green, g (s)	7.3	7.3	21.7	7.9	7.6		7.7	54.0	67.6	16.2	62.3	75.3
Actuated g/C Ratio	0.06	0.06	0.19	0.07	0.07		0.07	0.47	0.59	0.14	0.54	0.65
Clearance Time (s)	10.5	6.7		9.1	5.6		8.3	5.7		8.1	5.7	
Vehicle Extension (s)	3.0	3.0		3.0	3.0		3.0	3.0		3.0	3.0	
Lane Grp Cap (vph)	217	117	478	121	111		229	1584	895	244	1880	978
v/s Ratio Prot	0.03	0.03	0.01	c0.06	c0.08		0.05	0.23	0.04	c0.12	c0.51	0.04
v/s Ratio Perm												
v/c Ratio	0.44	0.54	0.03	0.93	1.18		0.70	0.49	0.07	0.84	0.95	0.07
Uniform Delay, d1	51.9	52.2	38.1	53.3	53.7		52.5	21.1	10.2	48.2	24.9	7.2
Progression Factor	1.00	1.00	1.00	1.00	1.00		1.00	1.00	1.00	1.00	1.00	1.00
Incremental Delay, d2	1.4	4.7	0.0	58.7	142.3		9.4	1.1	0.0	22.5	12.0	0.0
Delay (s)	53.3	56.9	38.1	111.9	196.0		61.9	22.2	10.2	70.7	36.9	7.2
Level of Service	D	E	D	F	F		E	C	B	E	D	A
Approach Delay (s)		49.0			164.8			27.0			38.8	
Approach LOS		D			F			C			D	
Intersection Summary												
HCM 2000 Control Delay			46.4			HCM 2000 Level of Service				D		
HCM 2000 Volume to Capacity ratio			1.02									
Actuated Cycle Length (s)			115.0			Sum of lost time (s)			30.1			
Intersection Capacity Utilization			87.3%			ICU Level of Service			E			
Analysis Period (min)			15									
c Critical Lane Group												

HCM Unsignalized Intersection Capacity Analysis

1: US 29 & Deerfield Drive

05/31/2021

													
Movement	EBL	EBT	EBR	WBL	WBT	WBR	NBL	NBT	NBR	SBL	SBT	SBR	
Lane Configurations													
Traffic Volume (veh/h)	50	1	22	9	4	18	33	1421	24	7	865	46	
Future Volume (Veh/h)	50	1	22	9	4	18	33	1421	24	7	865	46	
Sign Control		Stop			Stop			Free			Free		
Grade		0%			0%			0%			0%		
Peak Hour Factor	0.96	0.96	0.96	0.96	0.96	0.96	0.96	0.96	0.96	0.96	0.96	0.96	
Hourly flow rate (vph)	52	1	23	9	4	19	34	1480	25	7	901	48	
Pedestrians													
Lane Width (ft)													
Walking Speed (ft/s)													
Percent Blockage													
Right turn flare (veh)													
Median type													
Median storage (veh)													
Upstream signal (ft)													
pX, platoon unblocked	0.66	0.66		0.66	0.66	0.66					0.66		
vC, conflicting volume	1744	2488	450	2013	2511	740	949				1505		
vC1, stage 1 conf vol	915	915		1548	1548								
vC2, stage 2 conf vol	829	1573		465	963								
vCu, unblocked vol	1090	2221	450	1499	2256	0	949				726		
tC, single (s)	7.5	6.5	6.9	7.5	7.0	6.9	4.1				4.1		
tC, 2 stage (s)	6.5	5.5		6.5	6.0								
tF (s)	3.5	4.0	3.3	3.5	4.2	3.3	2.2				2.2		
p0 queue free %	80	99	96	95	97	97	95				99		
cM capacity (veh/h)	266	189	562	200	157	717	732				583		
Direction, Lane #	EB 1	WB 1	NB 1	NB 2	NB 3	NB 4	SB 1	SB 2	SB 3	SB 4			
Volume Total	76	32	34	740	740	25	7	450	450	48			
Volume Left	52	9	34	0	0	0	7	0	0	0			
Volume Right	23	19	0	0	0	25	0	0	0	48			
cSH	380	330	732	1700	1700	1700	583	1700	1700	1700			
Volume to Capacity	0.20	0.10	0.05	0.44	0.44	0.01	0.01	0.27	0.27	0.03			
Queue Length 95th (ft)	18	8	4	0	0	0	1	0	0	0			
Control Delay (s)	18.9	17.1	10.2	0.0	0.0	0.0	11.3	0.0	0.0	0.0			
Lane LOS	C	C	B				B						
Approach Delay (s)	18.9	17.1	0.2				0.1						
Approach LOS	C	C											
Intersection Summary													
Average Delay			0.9										
Intersection Capacity Utilization			54.4%		ICU Level of Service				A				
Analysis Period (min)			15										

Queues

2: US 29 & Matthew Mill Road

05/31/2021



Lane Group	EBT	EBR	WBL	WBT	WBR	NBL	NBT	NBR	SBL	SBT	SBR
Lane Group Flow (vph)	145	91	128	130	71	173	1358	383	99	776	64
v/c Ratio	0.78	0.23	0.65	0.63	0.19	0.69	0.83	0.40	0.81	0.56	0.08
Control Delay	78.4	1.4	65.3	63.7	1.2	62.8	33.8	3.2	98.5	31.4	0.2
Queue Delay	0.0	0.0	0.0	0.0	0.0	0.0	0.0	0.0	0.0	0.0	0.0
Total Delay	78.4	1.4	65.3	63.7	1.2	62.8	33.8	3.2	98.5	31.4	0.2
Queue Length 50th (ft)	109	0	101	102	0	129	478	0	77	246	0
Queue Length 95th (ft)	#249	0	165	166	0	195	579	53	#177	338	0
Internal Link Dist (ft)	263			737			534			690	
Turn Bay Length (ft)			600		575	300		355	625		
Base Capacity (vph)	186	389	259	270	419	361	1632	956	122	1381	757
Starvation Cap Reductn	0	0	0	0	0	0	0	0	0	0	0
Spillback Cap Reductn	0	0	0	0	0	0	0	0	0	0	0
Storage Cap Reductn	0	0	0	0	0	0	0	0	0	0	0
Reduced v/c Ratio	0.78	0.23	0.49	0.48	0.17	0.48	0.83	0.40	0.81	0.56	0.08























Intersection Summary

95th percentile volume exceeds capacity, queue may be longer.
 Queue shown is maximum after two cycles.

HCM Signalized Intersection Capacity Analysis

2: US 29 & Matthew Mill Road

05/31/2021

													
Movement	EBL	EBT	EBR	WBL	WBT	WBR	NBL	NBT	NBR	SBL	SBT	SBR	
Lane Configurations													
Traffic Volume (vph)	81	57	86	176	69	67	164	1290	364	94	737	61	
Future Volume (vph)	81	57	86	176	69	67	164	1290	364	94	737	61	
Ideal Flow (vphpl)	1900	1900	1900	1900	1900	1900	1900	1900	1900	1900	1900	1900	
Total Lost time (s)		6.5	6.5	6.5	6.5	6.5	6.0	7.0	7.0	6.0	7.0	7.0	
Lane Util. Factor		1.00	1.00	0.95	0.95	1.00	1.00	0.95	1.00	1.00	0.95	1.00	
Frt		1.00	0.85	1.00	1.00	0.85	1.00	1.00	0.85	1.00	1.00	0.85	
Flt Protected		0.97	1.00	0.95	0.98	1.00	0.95	1.00	1.00	0.95	1.00	1.00	
Satd. Flow (prot)		1846	1599	1681	1751	1599	1805	3505	1615	1805	3505	1615	
Flt Permitted		0.74	1.00	0.95	0.98	1.00	0.95	1.00	1.00	0.95	1.00	1.00	
Satd. Flow (perm)		1412	1599	1681	1751	1599	1805	3505	1615	1805	3505	1615	
Peak-hour factor, PHF	0.95	0.95	0.95	0.95	0.95	0.95	0.95	0.95	0.95	0.95	0.95	0.95	
Adj. Flow (vph)	85	60	91	185	73	71	173	1358	383	99	776	64	
RTOR Reduction (vph)	0	0	79	0	0	63	0	0	205	0	0	39	
Lane Group Flow (vph)	0	145	12	128	130	8	173	1358	178	99	776	25	
Heavy Vehicles (%)	0%	0%	1%	2%	0%	1%	0%	3%	0%	0%	3%	0%	
Turn Type	Perm	NA	Prot	Split	NA	Prot	Prot	NA	Prot	Prot	NA	Prot	
Protected Phases		4	4	3	3	3	5	2	2	1	6	6	
Permitted Phases	4												
Actuated Green, G (s)		15.9	15.9	14.1	14.1	14.1	16.7	55.9	55.9	8.1	47.3	47.3	
Effective Green, g (s)		15.9	15.9	14.1	14.1	14.1	16.7	55.9	55.9	8.1	47.3	47.3	
Actuated g/C Ratio		0.13	0.13	0.12	0.12	0.12	0.14	0.47	0.47	0.07	0.39	0.39	
Clearance Time (s)		6.5	6.5	6.5	6.5	6.5	6.0	7.0	7.0	6.0	7.0	7.0	
Vehicle Extension (s)		3.0	3.0	3.0	3.0	3.0	3.0	6.0	6.0	3.0	6.0	6.0	
Lane Grp Cap (vph)		187	211	197	205	187	251	1632	752	121	1381	636	
v/s Ratio Prot			0.01	c0.08	0.07	0.01	c0.10	c0.39	0.11	0.05	0.22	0.02	
v/s Ratio Perm	c0.10												
v/c Ratio		0.78	0.06	0.65	0.63	0.04	0.69	0.83	0.24	0.82	0.56	0.04	
Uniform Delay, d1		50.3	45.5	50.6	50.5	47.0	49.2	28.0	19.2	55.2	28.3	22.4	
Progression Factor		1.00	1.00	1.00	1.00	1.00	1.00	1.00	1.00	1.00	1.00	1.00	
Incremental Delay, d2		18.0	0.1	7.2	6.3	0.1	7.7	5.1	0.7	33.2	1.7	0.1	
Delay (s)		68.3	45.6	57.8	56.8	47.1	56.8	33.1	20.0	88.4	29.9	22.5	
Level of Service		E	D	E	E	D	E	C	B	F	C	C	
Approach Delay (s)		59.6			55.1			32.6			35.6		
Approach LOS		E			E			C			D		
Intersection Summary													
HCM 2000 Control Delay			37.5		HCM 2000 Level of Service					D			
HCM 2000 Volume to Capacity ratio			0.81										
Actuated Cycle Length (s)			120.0		Sum of lost time (s)				26.0				
Intersection Capacity Utilization			71.9%		ICU Level of Service					C			
Analysis Period (min)			15										
c Critical Lane Group													

HCM Unsignalized Intersection Capacity Analysis

3: US 29 & Heatherton Drive



















05/31/2021



Movement	EBL	EBR	NBL	NBT	SBT	SBR	
Lane Configurations							
Traffic Volume (veh/h)	8	12	57	1810	985	14	
Future Volume (Veh/h)	8	12	57	1810	985	14	
Sign Control	Stop			Free	Free		
Grade	0%			0%	0%		
Peak Hour Factor	0.95	0.95	0.95	0.95	0.95	0.95	
Hourly flow rate (vph)	8	13	60	1905	1037	15	
Pedestrians							
Lane Width (ft)							
Walking Speed (ft/s)							
Percent Blockage							
Right turn flare (veh)							
Median type				Raised	Raised		
Median storage (veh)				2	2		
Upstream signal (ft)				614			
pX, platoon unblocked	0.83	0.83	0.83				
vC, conflicting volume	2110	518	1052				
vC1, stage 1 conf vol	1037						
vC2, stage 2 conf vol	1072						
vCu, unblocked vol	1926	8	652				
tC, single (s)	6.8	6.9	4.1				
tC, 2 stage (s)	5.8						
tF (s)	3.5	3.3	2.2				
p0 queue free %	96	99	92				
cM capacity (veh/h)	223	894	783				
Direction, Lane #	EB 1	NB 1	NB 2	NB 3	SB 1	SB 2	SB 3
Volume Total	21	60	952	952	518	518	15
Volume Left	8	60	0	0	0	0	0
Volume Right	13	0	0	0	0	0	15
cSH	417	783	1700	1700	1700	1700	1700
Volume to Capacity	0.05	0.08	0.56	0.56	0.30	0.30	0.01
Queue Length 95th (ft)	4	6	0	0	0	0	0
Control Delay (s)	14.1	10.0	0.0	0.0	0.0	0.0	0.0
Lane LOS	B	A					
Approach Delay (s)	14.1	0.3	0.0				
Approach LOS	B						
Intersection Summary							
Average Delay	0.3						
Intersection Capacity Utilization	60.0%			ICU Level of Service	B		
Analysis Period (min)	15						

HCM Unsignalized Intersection Capacity Analysis
 4: US 29 & Terrace Greene Circle

06/10/2021

												
Movement	EBL	EBT	EBR	WBL	WBT	WBR	NBL	NBT	NBR	SBL	SBT	SBR
Lane Configurations												
Traffic Volume (veh/h)	0	0	0	0	0	57	0	1815	108	0	963	0
Future Volume (Veh/h)	0	0	0	0	0	57	0	1815	108	0	963	0
Sign Control	Stop			Stop			Free			Free		
Grade	0%			0%			0%			0%		
Peak Hour Factor	0.92	0.92	0.92	0.92	0.92	0.92	0.90	0.90	0.90	0.90	0.90	0.90
Hourly flow rate (vph)	0	0	0	0	0	62	0	2017	120	0	1070	0
Pedestrians												
Lane Width (ft)												
Walking Speed (ft/s)												
Percent Blockage												
Right turn flare (veh)												
Median type							Raised			Raised		
Median storage (veh)							2			2		
Upstream signal (ft)												
pX, platoon unblocked												
vC, conflicting volume	2140	3207	535	2552	3087	1008	1070				2137	
vC1, stage 1 conf vol	1070	1070		2017	2017							
vC2, stage 2 conf vol	1070	2137		535	1070							
vCu, unblocked vol	2140	3207	535	2552	3087	1008	1070				2137	
tC, single (s)	7.5	6.5	6.9	7.5	6.5	6.9	4.1				4.1	
tC, 2 stage (s)	6.5	5.5		6.5	5.5							
tF (s)	3.5	4.0	3.3	3.5	4.0	3.3	2.2				2.2	
p0 queue free %	100	100	100	100	100	74	100				100	
cM capacity (veh/h)	136	81	490	58	93	238	659				257	
Direction, Lane #	EB 1	WB 1	NB 1	NB 2	NB 3	SB 1	SB 2	SB 3				
Volume Total	0	62	1008	1008	120	535	535	0				
Volume Left	0	0	0	0	0	0	0	0				
Volume Right	0	62	0	0	120	0	0	0				
cSH	1700	238	1700	1700	1700	1700	1700	1700				
Volume to Capacity	0.00	0.26	0.59	0.59	0.07	0.31	0.31	0.00				
Queue Length 95th (ft)	0	25	0	0	0	0	0	0				
Control Delay (s)	0.0	25.3	0.0	0.0	0.0	0.0	0.0	0.0				
Lane LOS	A	D										
Approach Delay (s)	0.0	25.3	0.0					0.0				
Approach LOS	A	D										
Intersection Summary												
Average Delay			0.5									
Intersection Capacity Utilization			60.4%	ICU Level of Service				B				
Analysis Period (min)			15									

HCM Unsignalized Intersection Capacity Analysis

5: US 29 & Keleigh Lane

05/31/2021























Movement	EBL	EBR	NBL	NBT	SBT	SBR	
Lane Configurations							
Traffic Volume (veh/h)	11	10	26	1979	942	17	
Future Volume (Veh/h)	11	10	26	1979	942	17	
Sign Control	Stop			Free	Free		
Grade	0%			0%	0%		
Peak Hour Factor	0.96	0.96	0.96	0.96	0.96	0.96	
Hourly flow rate (vph)	11	10	27	2061	981	18	
Pedestrians							
Lane Width (ft)							
Walking Speed (ft/s)							
Percent Blockage							
Right turn flare (veh)							
Median type				Raised	Raised		
Median storage (veh)				2	2		
Upstream signal (ft)							
pX, platoon unblocked							
vC, conflicting volume	2066	490	999				
vC1, stage 1 conf vol	981						
vC2, stage 2 conf vol	1084						
vCu, unblocked vol	2066	490	999				
tC, single (s)	6.8	6.9	4.1				
tC, 2 stage (s)	5.8						
tF (s)	3.5	3.3	2.2				
p0 queue free %	95	98	96				
cM capacity (veh/h)	211	529	701				
Direction, Lane #	EB 1	NB 1	NB 2	NB 3	SB 1	SB 2	SB 3
Volume Total	21	27	1030	1030	490	490	18
Volume Left	11	27	0	0	0	0	0
Volume Right	10	0	0	0	0	0	18
cSH	295	701	1700	1700	1700	1700	1700
Volume to Capacity	0.07	0.04	0.61	0.61	0.29	0.29	0.01
Queue Length 95th (ft)	6	3	0	0	0	0	0
Control Delay (s)	18.1	10.3	0.0	0.0	0.0	0.0	0.0
Lane LOS	C	B					
Approach Delay (s)	18.1	0.1	0.0				
Approach LOS	C						
Intersection Summary							
Average Delay			0.2				
Intersection Capacity Utilization			64.7%	ICU Level of Service	C		
Analysis Period (min)			15				

HCM Unsignalized Intersection Capacity Analysis

6: US 29 & Commercial Entrance

05/31/2021

												
Movement	EBL	EBT	EBR	WBL	WBT	WBR	NBL	NBT	NBR	SBL	SBT	SBR
Lane Configurations												
Traffic Volume (veh/h)	0	0	0	3	0	44	11	1931	29	65	893	0
Future Volume (Veh/h)	0	0	0	3	0	44	11	1931	29	65	893	0
Sign Control		Stop			Stop			Free			Free	
Grade		0%			0%			0%			0%	
Peak Hour Factor	0.97	0.97	0.97	0.97	0.97	0.97	0.97	0.97	0.97	0.97	0.97	0.97
Hourly flow rate (vph)	0	0	0	3	0	45	11	1991	30	67	921	0
Pedestrians												
Lane Width (ft)												
Walking Speed (ft/s)												
Percent Blockage												
Right turn flare (veh)												
Median type												
Median storage veh												
Upstream signal (ft)												
pX, platoon unblocked												
vC, conflicting volume	2095	3098	460	2608	3068	996	921			2021		
vC1, stage 1 conf vol	1055	1055		2013	2013							
vC2, stage 2 conf vol	1040	2043		594	1055							
vCu, unblocked vol	2095	3098	460	2608	3068	996	921			2021		
tC, single (s)	7.5	6.5	6.9	7.5	6.5	6.9	4.1			4.1		
tC, 2 stage (s)	6.5	5.5		6.5	5.5							
tF (s)	3.5	4.0	3.3	3.5	4.0	3.3	2.2			2.2		
p0 queue free %	100	100	100	95	100	82	99			76		
cM capacity (veh/h)	107	31	553	59	89	247	750			278		
Direction, Lane #	EB 1	WB 1	NB 1	NB 2	NB 3	NB 4	SB 1	SB 2	SB 3			
Volume Total	0	48	11	996	996	30	67	460	460			
Volume Left	0	3	11	0	0	0	67	0	0			
Volume Right	0	45	0	0	0	30	0	0	0			
cSH	1700	263	750	1700	1700	1700	278	1700	1700			
Volume to Capacity	0.00	0.18	0.01	0.59	0.59	0.02	0.24	0.27	0.27			
Queue Length 95th (ft)	0	16	1	0	0	0	23	0	0			
Control Delay (s)	0.0	25.8	9.9	0.0	0.0	0.0	22.0	0.0	0.0			
Lane LOS	A	D	A				C					
Approach Delay (s)	0.0	25.8	0.1				1.5					
Approach LOS	A	D										
Intersection Summary												
Average Delay			0.9									
Intersection Capacity Utilization			64.0%		ICU Level of Service				C			
Analysis Period (min)			15									

HCM Unsignalized Intersection Capacity Analysis

7: US 29 & Lake Saponi Drive

05/31/2021



Movement	WBL	WBR	NBT	NBR	SBL	SBT
Lane Configurations		↗	↕	↗		↕
Traffic Volume (veh/h)	0	36	1915	48	0	905
Future Volume (Veh/h)	0	36	1915	48	0	905
Sign Control	Stop		Free			Free
Grade	0%		0%			0%
Peak Hour Factor	0.95	0.95	0.95	0.95	0.95	0.95
Hourly flow rate (vph)	0	38	2016	51	0	953
Pedestrians						
Lane Width (ft)						
Walking Speed (ft/s)						
Percent Blockage						
Right turn flare (veh)						
Median type			Raised			Raised
Median storage (veh)			2			2
Upstream signal (ft)						
pX, platoon unblocked						
vC, conflicting volume	2492	1008			2067	
vC1, stage 1 conf vol	2016					
vC2, stage 2 conf vol	476					
vCu, unblocked vol	2492	1008			2067	
tC, single (s)	6.8	7.0			4.1	
tC, 2 stage (s)	5.8					
tF (s)	3.5	3.4			2.2	
p0 queue free %	100	84			100	
cM capacity (veh/h)	88	232			274	
Direction, Lane #	WB 1	NB 1	NB 2	NB 3	SB 1	SB 2
Volume Total	38	1008	1008	51	476	476
Volume Left	0	0	0	0	0	0
Volume Right	38	0	0	51	0	0
cSH	232	1700	1700	1700	1700	1700
Volume to Capacity	0.16	0.59	0.59	0.03	0.28	0.28
Queue Length 95th (ft)	14	0	0	0	0	0
Control Delay (s)	23.6	0.0	0.0	0.0	0.0	0.0
Lane LOS	C					
Approach Delay (s)	23.6	0.0			0.0	
Approach LOS	C					
Intersection Summary						
Average Delay			0.3			
Intersection Capacity Utilization			62.9%	ICU Level of Service	B	
Analysis Period (min)			15			

HCM Unsignalized Intersection Capacity Analysis

8: US 29 & Greene Edge Lane

05/31/2021



Movement	EBL	EBR	NBL	NBT	SBT	SBR
Lane Configurations						
Traffic Volume (veh/h)	0	0	1	1969	883	1
Future Volume (Veh/h)	0	0	1	1969	883	1
Sign Control	Stop			Free	Free	
Grade	0%			0%	0%	
Peak Hour Factor	0.97	0.97	0.97	0.97	0.97	0.97
Hourly flow rate (vph)	0	0	1	2030	910	1
Pedestrians						
Lane Width (ft)						
Walking Speed (ft/s)						
Percent Blockage						
Right turn flare (veh)						
Median type			Raised	Raised		
Median storage (veh)			2	2		
Upstream signal (ft)						
pX, platoon unblocked						
vC, conflicting volume	1928	456	911			
vC1, stage 1 conf vol	910					
vC2, stage 2 conf vol	1017					
vCu, unblocked vol	1928	456	911			
tC, single (s)	6.8	6.9	4.1			
tC, 2 stage (s)	5.8					
tF (s)	3.5	3.3	2.2			
p0 queue free %	100	100	100			
cM capacity (veh/h)	237	557	756			
Direction, Lane #	EB 1	NB 1	NB 2	SB 1	SB 2	
Volume Total	0	678	1353	607	304	
Volume Left	0	1	0	0	0	
Volume Right	0	0	0	0	1	
cSH	1700	756	1700	1700	1700	
Volume to Capacity	0.00	0.00	0.80	0.36	0.18	
Queue Length 95th (ft)	0	0	0	0	0	
Control Delay (s)	0.0	0.0	0.0	0.0	0.0	
Lane LOS	A	A				
Approach Delay (s)	0.0	0.0		0.0		
Approach LOS	A					
Intersection Summary						
Average Delay			0.0			
Intersection Capacity Utilization			58.5%	ICU Level of Service	B	
Analysis Period (min)			15			

Queues

9: US 29 & Frays Mill Road

05/31/2021



Lane Group	EBT	WBT	NBL	NBT	NBR	SBL	SBT	SBR
Lane Group Flow (vph)	62	112	123	2000	109	34	926	8
v/c Ratio	0.39	0.82	0.65	0.90	0.10	0.27	0.49	0.01
Control Delay	34.4	70.3	67.8	29.2	1.4	58.2	19.3	0.0
Queue Delay	0.0	0.0	0.0	0.0	0.0	0.0	0.0	0.0
Total Delay	34.4	70.3	67.8	29.2	1.4	58.2	19.3	0.0
Queue Length 50th (ft)	20	47	92	~817	0	26	244	0
Queue Length 95th (ft)	65	#150	157	#1021	17	60	309	0
Internal Link Dist (ft)	273	256		1061			946	
Turn Bay Length (ft)			350		350	375		375
Base Capacity (vph)	168	139	210	2219	1063	136	1892	942
Starvation Cap Reductn	0	0	0	0	0	0	0	0
Spillback Cap Reductn	0	0	0	0	0	0	0	0
Storage Cap Reductn	0	0	0	0	0	0	0	0
Reduced v/c Ratio	0.37	0.81	0.59	0.90	0.10	0.25	0.49	0.01

Intersection Summary

~ Volume exceeds capacity, queue is theoretically infinite.

Queue shown is maximum after two cycles.

95th percentile volume exceeds capacity, queue may be longer.

Queue shown is maximum after two cycles.

HCM Signalized Intersection Capacity Analysis
 9: US 29 & Frays Mill Road

05/31/2021

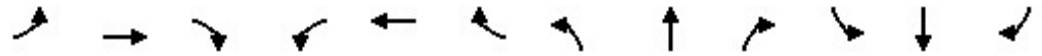



















Movement	EBL	EBT	EBR	WBL	WBT	WBR	NBL	NBT	NBR	SBL	SBT	SBR
Lane Configurations		↔			↔		↗	↕	↗	↗	↕	↗
Traffic Volume (vph)	16	11	34	34	9	67	121	1960	107	33	907	8
Future Volume (vph)	16	11	34	34	9	67	121	1960	107	33	907	8
Ideal Flow (vphpl)	1900	1900	1900	1900	1900	1900	1900	1900	1900	1900	1900	1900
Total Lost time (s)		6.0			6.0		6.0	6.0	6.0	6.0	6.0	6.0
Lane Util. Factor		1.00			1.00		1.00	0.95	1.00	1.00	0.95	1.00
Frt		0.92			0.92		1.00	1.00	0.85	1.00	1.00	0.85
Flt Protected		0.99			0.98		0.95	1.00	1.00	0.95	1.00	1.00
Satd. Flow (prot)		1678			1662		1787	3539	1615	1805	3471	1615
Flt Permitted		0.88			0.60		0.95	1.00	1.00	0.95	1.00	1.00
Satd. Flow (perm)		1488			1018		1787	3539	1615	1805	3471	1615
Peak-hour factor, PHF	0.98	0.98	0.98	0.98	0.98	0.98	0.98	0.98	0.98	0.98	0.98	0.98
Adj. Flow (vph)	16	11	35	35	9	68	123	2000	109	34	926	8
RTOR Reduction (vph)	0	33	0	0	46	0	0	0	44	0	0	4
Lane Group Flow (vph)	0	29	0	0	66	0	123	2000	65	34	926	4
Heavy Vehicles (%)	0%	9%	3%	6%	11%	1%	1%	2%	0%	0%	4%	0%
Turn Type	Perm	NA		Perm	NA		Prot	NA	Prot	Prot	NA	Prot
Protected Phases		4			3		5	2	2	1	6	6
Permitted Phases	4			3								
Actuated Green, G (s)		8.3			10.8		12.7	71.6	71.6	5.3	64.2	64.2
Effective Green, g (s)		8.3			10.8		12.7	71.6	71.6	5.3	64.2	64.2
Actuated g/C Ratio		0.07			0.09		0.11	0.60	0.60	0.04	0.54	0.54
Clearance Time (s)		6.0			6.0		6.0	6.0	6.0	6.0	6.0	6.0
Vehicle Extension (s)		4.0			4.0		3.5	6.0	6.0	3.5	6.0	6.0
Lane Grp Cap (vph)		102			91		189	2111	963	79	1856	864
v/s Ratio Prot							c0.07	c0.57	0.04	0.02	0.27	0.00
v/s Ratio Perm		c0.02			c0.06							
v/c Ratio		0.29			0.72		0.65	0.95	0.07	0.43	0.50	0.00
Uniform Delay, d1		53.0			53.1		51.5	22.5	10.2	55.9	17.7	13.0
Progression Factor		1.00			1.00		1.00	1.00	1.00	1.00	1.00	1.00
Incremental Delay, d2		2.1			25.8		8.1	10.6	0.1	4.4	1.0	0.0
Delay (s)		55.2			78.9		59.6	33.1	10.3	60.3	18.7	13.0
Level of Service		E			E		E	C	B	E	B	B
Approach Delay (s)		55.2			78.9			33.4			20.1	
Approach LOS		E			E			C			C	
Intersection Summary												
HCM 2000 Control Delay			31.5				HCM 2000 Level of Service			C		
HCM 2000 Volume to Capacity ratio			0.87									
Actuated Cycle Length (s)			120.0				Sum of lost time (s)			24.0		
Intersection Capacity Utilization			85.0%				ICU Level of Service			E		
Analysis Period (min)			15									
c Critical Lane Group												

HCM Unsignalized Intersection Capacity Analysis

10: US 29 & Dickerson Road

05/31/2021

												
Movement	EBL	EBT	EBR	WBL	WBT	WBR	NBL	NBT	NBR	SBL	SBT	SBR
Lane Configurations												
Traffic Volume (veh/h)	23	0	11	0	0	0	34	2134	2	1	935	14
Future Volume (Veh/h)	23	0	11	0	0	0	34	2134	2	1	935	14
Sign Control		Stop			Stop			Free			Free	
Grade		0%			0%			0%			0%	
Peak Hour Factor	0.96	0.96	0.96	0.96	0.96	0.96	0.96	0.96	0.96	0.96	0.96	0.96
Hourly flow rate (vph)	24	0	11	0	0	0	35	2223	2	1	974	15
Pedestrians												
Lane Width (ft)												
Walking Speed (ft/s)												
Percent Blockage												
Right turn flare (veh)												
Median type												
Median storage (veh)												
Upstream signal (ft)												
pX, platoon unblocked												
vC, conflicting volume	2158	3271	487	2794	3285	1112	989			2225		
vC1, stage 1 conf vol	976	976		2294	2294							
vC2, stage 2 conf vol	1182	2295		500	991							
vCu, unblocked vol	2158	3271	487	2794	3285	1112	989			2225		
tC, single (s)	7.7	6.5	6.9	7.5	6.5	6.9	4.2			4.1		
tC, 2 stage (s)	6.7	5.5		6.5	5.5							
tF (s)	3.6	4.0	3.3	3.5	4.0	3.3	2.3			2.2		
p0 queue free %	83	100	98	100	100	100	95			100		
cM capacity (veh/h)	143	66	532	38	67	206	671			238		
Direction, Lane #	EB 1	WB 1	NB 1	NB 2	NB 3	SB 1	SB 2	SB 3	SB 4			
Volume Total	35	0	35	1482	743	1	487	487	15			
Volume Left	24	0	35	0	0	1	0	0	0			
Volume Right	11	0	0	0	2	0	0	0	15			
cSH	185	1700	671	1700	1700	238	1700	1700	1700			
Volume to Capacity	0.19	0.00	0.05	0.87	0.44	0.00	0.29	0.29	0.01			
Queue Length 95th (ft)	17	0	4	0	0	0	0	0	0			
Control Delay (s)	28.9	0.0	10.7	0.0	0.0	20.2	0.0	0.0	0.0			
Lane LOS	D	A	B			C						
Approach Delay (s)	28.9	0.0	0.2			0.0						
Approach LOS	D	A										
Intersection Summary												
Average Delay			0.4									
Intersection Capacity Utilization			69.1%		ICU Level of Service				C			
Analysis Period (min)			15									

Queues

11: US 29 & Austin Drive

05/31/2021





















Lane Group	EBL	EBT	NBL	NBT	SBT	SBR
Lane Group Flow (vph)	10	35	27	2236	973	22
v/c Ratio	0.09	0.09	0.25	0.71	0.34	0.02
Control Delay	55.4	0.4	58.3	5.3	6.1	0.0
Queue Delay	0.0	0.0	0.0	0.0	0.0	0.0
Total Delay	55.4	0.4	58.3	5.3	6.1	0.0
Queue Length 50th (ft)	8	0	20	344	148	0
Queue Length 95th (ft)	26	0	50	435	203	0
Internal Link Dist (ft)		306		669	657	
Turn Bay Length (ft)			500			350
Base Capacity (vph)	112	414	174	3155	2844	1224
Starvation Cap Reductn	0	0	0	0	0	0
Spillback Cap Reductn	0	0	0	0	0	0
Storage Cap Reductn	0	0	0	0	0	0
Reduced v/c Ratio	0.09	0.08	0.16	0.71	0.34	0.02

Intersection Summary

HCM Signalized Intersection Capacity Analysis

11: US 29 & Austin Drive

05/31/2021

												
Movement	EBL	EBT	EBR	WBL	WBT	WBR	NBL	NBT	NBR	SBL	SBT	SBR
Lane Configurations												
Traffic Volume (vph)	10	0	34	0	0	0	26	2147	0	0	934	21
Future Volume (vph)	10	0	34	0	0	0	26	2147	0	0	934	21
Ideal Flow (vphpl)	1900	1900	1900	1900	1900	1900	1900	1900	1900	1900	1900	1900
Total Lost time (s)	7.5	7.5					7.5	7.0			7.0	7.0
Lane Util. Factor	1.00	1.00					1.00	0.95			0.95	1.00
Frt	1.00	0.85					1.00	1.00			1.00	0.85
Flt Protected	0.95	1.00					0.95	1.00			1.00	1.00
Satd. Flow (prot)	1805	1568					1671	3539			3505	1468
Flt Permitted	0.95	1.00					0.95	1.00			1.00	1.00
Satd. Flow (perm)	1805	1568					1671	3539			3505	1468
Peak-hour factor, PHF	0.96	0.96	0.96	0.96	0.96	0.96	0.96	0.96	0.96	0.96	0.96	0.96
Adj. Flow (vph)	10	0	35	0	0	0	27	2236	0	0	973	22
RTOR Reduction (vph)	0	34	0	0	0	0	0	0	0	0	0	6
Lane Group Flow (vph)	10	1	0	0	0	0	27	2236	0	0	973	16
Heavy Vehicles (%)	0%	0%	3%	0%	0%	0%	8%	2%	0%	0%	3%	10%
Turn Type	Split	NA					Prot	NA			NA	Prot
Protected Phases	4	4			3		5	2			6	6
Permitted Phases				3						6		
Actuated Green, G (s)	4.3	4.3					5.1	101.2			88.6	88.6
Effective Green, g (s)	4.3	4.3					5.1	101.2			88.6	88.6
Actuated g/C Ratio	0.04	0.04					0.04	0.84			0.74	0.74
Clearance Time (s)	7.5	7.5					7.5	7.0			7.0	7.0
Vehicle Extension (s)	3.0	3.0					3.0	3.0			3.0	3.0
Lane Grp Cap (vph)	64	56					71	2984			2587	1083
v/s Ratio Prot	c0.01	0.00					0.02	c0.63			0.28	0.01
v/s Ratio Perm												
v/c Ratio	0.16	0.02					0.38	0.75			0.38	0.01
Uniform Delay, d1	56.1	55.8					55.9	4.0			5.7	4.2
Progression Factor	1.00	1.00					1.00	1.00			1.00	1.00
Incremental Delay, d2	1.1	0.2					3.4	1.8			0.4	0.0
Delay (s)	57.2	56.0					59.3	5.8			6.1	4.2
Level of Service	E	E					E	A			A	A
Approach Delay (s)		56.3			0.0			6.4			6.1	
Approach LOS		E			A			A			A	
Intersection Summary												
HCM 2000 Control Delay			7.0				HCM 2000 Level of Service				A	
HCM 2000 Volume to Capacity ratio			0.84									
Actuated Cycle Length (s)			120.0				Sum of lost time (s)			29.0		
Intersection Capacity Utilization			87.7%				ICU Level of Service			E		
Analysis Period (min)			15									
c Critical Lane Group												

Queues

12: US 29 & Boulders Road

05/31/2021

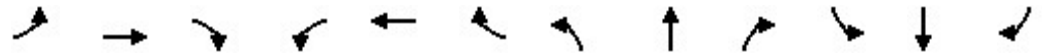

Lane Group	EBL	EBT	EBR	WBL	WBT	WBR	NBL	NBT	NBR	SBL	SBT	SBR
Lane Group Flow (vph)	18	23	80	78	78	83	119	2078	13	5	957	33
v/c Ratio	0.18	0.11	0.35	0.70	0.69	0.34	0.61	0.83	0.01	0.02	0.48	0.03
Control Delay	57.1	54.0	4.2	85.6	84.9	4.1	63.4	18.6	0.0	53.6	17.8	0.1
Queue Delay	0.0	0.0	0.0	0.0	0.0	0.0	0.0	0.0	0.0	0.0	0.0	0.0
Total Delay	57.1	54.0	4.2	85.6	84.9	4.1	63.4	18.6	0.0	53.6	17.8	0.1
Queue Length 50th (ft)	15	9	0	63	63	0	89	535	0	2	232	0
Queue Length 95th (ft)	41	24	0	#143	#142	3	146	#1029	0	8	328	0
Internal Link Dist (ft)		179			369			731			699	
Turn Bay Length (ft)			175			350	400		300	550		425
Base Capacity (vph)	316	639	404	115	116	244	222	2498	1184	542	1994	957
Starvation Cap Reductn	0	0	0	0	0	0	0	0	0	0	0	0
Spillback Cap Reductn	0	0	0	0	0	0	0	0	0	0	0	0
Storage Cap Reductn	0	0	0	0	0	0	0	0	0	0	0	0
Reduced v/c Ratio	0.06	0.04	0.20	0.68	0.67	0.34	0.54	0.83	0.01	0.01	0.48	0.03

Intersection Summary

95th percentile volume exceeds capacity, queue may be longer.
 Queue shown is maximum after two cycles.

HCM Signalized Intersection Capacity Analysis

12: US 29 & Boulders Road

05/31/2021

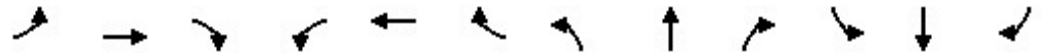





















Movement	EBL	EBT	EBR	WBL	WBT	WBR	NBL	NBT	NBR	SBL	SBT	SBR
Lane Configurations												
Traffic Volume (vph)	37	4	79	143	12	82	118	2057	13	5	947	33
Future Volume (vph)	37	4	79	143	12	82	118	2057	13	5	947	33
Ideal Flow (vphp)	1900	1900	1900	1900	1900	1900	1900	1900	1900	1900	1900	1900
Total Lost time (s)	6.9	6.9	6.9	6.9	6.9	6.9	5.9	6.2	6.2	6.4	6.0	6.0
Lane Util. Factor	0.91	0.91	1.00	0.95	0.95	1.00	1.00	0.95	1.00	0.97	0.95	1.00
Frt	1.00	1.00	0.85	1.00	1.00	0.85	1.00	1.00	0.85	1.00	1.00	0.85
Flt Protected	0.95	0.96	1.00	0.95	0.96	1.00	0.95	1.00	1.00	0.95	1.00	1.00
Satd. Flow (prot)	1643	3321	1495	1715	1732	1615	1752	3539	1615	3502	3505	1568
Flt Permitted	0.95	0.96	1.00	0.95	0.96	1.00	0.95	1.00	1.00	0.95	1.00	1.00
Satd. Flow (perm)	1643	3321	1495	1715	1732	1615	1752	3539	1615	3502	3505	1568
Peak-hour factor, PHF	0.99	0.99	0.99	0.99	0.99	0.99	0.99	0.99	0.99	0.99	0.99	0.99
Adj. Flow (vph)	37	4	80	144	12	83	119	2078	13	5	957	33
RTOR Reduction (vph)	0	0	76	0	0	78	0	0	5	0	0	15
Lane Group Flow (vph)	18	23	4	78	78	5	119	2078	8	5	957	18
Heavy Vehicles (%)	0%	0%	8%	0%	0%	0%	3%	2%	0%	0%	3%	3%
Turn Type	Split	NA	Prot	Split	NA	Prot	Prot	NA	Prot	Prot	NA	Prot
Protected Phases	4	4	4	3	3	3	5	2	2	1	6	6
Permitted Phases												
Actuated Green, G (s)	6.1	6.1	6.1	7.9	7.9	7.9	13.4	78.2	78.2	1.4	66.9	66.9
Effective Green, g (s)	6.1	6.1	6.1	7.9	7.9	7.9	13.4	78.2	78.2	1.4	66.9	66.9
Actuated g/C Ratio	0.05	0.05	0.05	0.07	0.07	0.07	0.11	0.65	0.65	0.01	0.56	0.56
Clearance Time (s)	6.9	6.9	6.9	6.9	6.9	6.9	5.9	6.2	6.2	6.4	6.0	6.0
Vehicle Extension (s)	3.0	3.0	3.0	3.0	3.0	3.0	3.0	3.0	3.0	3.0	3.0	3.0
Lane Grp Cap (vph)	83	168	75	112	114	106	195	2306	1052	40	1954	874
v/s Ratio Prot	c0.01	0.01	0.00	c0.05	0.05	0.00	c0.07	c0.59	0.01	0.00	0.27	0.01
v/s Ratio Perm												
v/c Ratio	0.22	0.14	0.05	0.70	0.68	0.05	0.61	0.90	0.01	0.12	0.49	0.02
Uniform Delay, d1	54.7	54.4	54.2	54.9	54.8	52.5	50.8	17.6	7.3	58.7	16.2	11.9
Progression Factor	1.00	1.00	1.00	1.00	1.00	1.00	1.00	1.00	1.00	1.00	1.00	1.00
Incremental Delay, d2	1.3	0.4	0.3	17.2	15.7	0.2	5.5	6.2	0.0	1.4	0.9	0.0
Delay (s)	56.0	54.8	54.5	72.0	70.5	52.7	56.4	23.9	7.3	60.1	17.0	11.9
Level of Service	E	D	D	E	E	D	E	C	A	E	B	B
Approach Delay (s)		54.8			64.8			25.5			17.1	
Approach LOS		D			E			C			B	

Intersection Summary

HCM 2000 Control Delay	26.8	HCM 2000 Level of Service	C
HCM 2000 Volume to Capacity ratio	0.86		
Actuated Cycle Length (s)	120.0	Sum of lost time (s)	26.4
Intersection Capacity Utilization	89.9%	ICU Level of Service	E
Analysis Period (min)	15		
c Critical Lane Group			

HCM Unsignalized Intersection Capacity Analysis
 13: US 29 & Camelot Drive

05/31/2021

												
Movement	EBL	EBT	EBR	WBL	WBT	WBR	NBL	NBT	NBR	SBL	SBT	SBR
Lane Configurations												
Traffic Volume (veh/h)	3	0	32	10	0	14	75	2164	4	1	1175	6
Future Volume (Veh/h)	3	0	32	10	0	14	75	2164	4	1	1175	6
Sign Control		Stop			Stop			Free			Free	
Grade		0%			0%			0%			0%	
Peak Hour Factor	0.93	0.93	0.93	0.93	0.93	0.93	0.93	0.93	0.93	0.93	0.93	0.93
Hourly flow rate (vph)	3	0	34	11	0	15	81	2327	4	1	1263	6
Pedestrians												
Lane Width (ft)												
Walking Speed (ft/s)												
Percent Blockage												
Right turn flare (veh)												
Median type								Raised			Raised	
Median storage (veh)								2			2	
Upstream signal (ft)												
pX, platoon unblocked												
vC, conflicting volume	2606	3758	632	3156	3760	1164	1269			2331		
vC1, stage 1 conf vol	1265	1265		2489	2489							
vC2, stage 2 conf vol	1340	2493		668	1271							
vCu, unblocked vol	2606	3758	632	3156	3760	1164	1269			2331		
tC, single (s)	7.5	6.5	7.0	7.5	6.5	7.2	4.1			4.1		
tC, 2 stage (s)	6.5	5.5		6.5	5.5							
tF (s)	3.5	4.0	3.3	3.5	4.0	3.4	2.2			2.2		
p0 queue free %	97	100	92	57	100	91	85			100		
cM capacity (veh/h)	99	47	421	25	46	170	549			216		
Direction, Lane #	EB 1	WB 1	NB 1	NB 2	NB 3	NB 4	SB 1	SB 2	SB 3	SB 4		
Volume Total	37	26	81	1164	1164	4	1	632	632	6		
Volume Left	3	11	81	0	0	0	1	0	0	0		
Volume Right	34	15	0	0	0	4	0	0	0	6		
cSH	333	50	549	1700	1700	1700	216	1700	1700	1700		
Volume to Capacity	0.11	0.52	0.15	0.68	0.68	0.00	0.00	0.37	0.37	0.00		
Queue Length 95th (ft)	9	49	13	0	0	0	0	0	0	0		
Control Delay (s)	17.2	139.1	12.7	0.0	0.0	0.0	21.8	0.0	0.0	0.0		
Lane LOS	C	F	B				C					
Approach Delay (s)	17.2	139.1	0.4				0.0					
Approach LOS	C	F										
Intersection Summary												
Average Delay			1.4									
Intersection Capacity Utilization			73.3%		ICU Level of Service					D		
Analysis Period (min)			15									

Queues

14: US 29 & Lewis and Clark Drive

05/31/2021



Lane Group	EBL	EBR	NBL	NBT	SBT	SBR
Lane Group Flow (vph)	155	49	18	2173	1209	39
v/c Ratio	0.67	0.22	0.22	0.80	0.48	0.03
Control Delay	63.5	14.6	59.1	11.6	9.4	2.8
Queue Delay	0.0	0.0	0.0	0.0	0.0	0.0
Total Delay	63.5	14.6	59.1	11.6	9.4	2.8
Queue Length 50th (ft)	115	0	14	453	148	0
Queue Length 95th (ft)	183	36	38	627	329	13
Internal Link Dist (ft)	654			696	637	
Turn Bay Length (ft)			450			375
Base Capacity (vph)	285	267	96	2728	2528	1142
Starvation Cap Reductn	0	0	0	0	0	0
Spillback Cap Reductn	0	0	0	0	0	0
Storage Cap Reductn	0	0	0	0	0	0
Reduced v/c Ratio	0.54	0.18	0.19	0.80	0.48	0.03

Intersection Summary

HCM Signalized Intersection Capacity Analysis

14: US 29 & Lewis and Clark Drive

05/31/2021



Movement	EBL	EBR	NBL	NBT	SBU	SBT	SBR
Lane Configurations							
Traffic Volume (vph)	149	47	17	2086	0	1161	37
Future Volume (vph)	149	47	17	2086	0	1161	37
Ideal Flow (vphpl)	1900	1900	1900	1900	1900	1900	1900
Total Lost time (s)	6.0	6.0	6.0	6.0		6.0	6.0
Lane Util. Factor	1.00	1.00	1.00	0.95		0.95	1.00
Frt	1.00	0.85	1.00	1.00		1.00	0.85
Flt Protected	0.95	1.00	0.95	1.00		1.00	1.00
Satd. Flow (prot)	1805	1429	1280	3539		3505	1568
Flt Permitted	0.95	1.00	0.95	1.00		1.00	1.00
Satd. Flow (perm)	1805	1429	1280	3539		3505	1568
Peak-hour factor, PHF	0.96	0.96	0.96	0.96	0.92	0.96	0.96
Adj. Flow (vph)	155	49	18	2173	0	1209	39
RTOR Reduction (vph)	0	43	0	0	0	0	12
Lane Group Flow (vph)	155	6	18	2173	0	1209	27
Heavy Vehicles (%)	0%	13%	41%	2%	2%	3%	3%
Turn Type	Prot	Prot	Prot	NA	Prot	NA	Prot
Protected Phases	4	4	5	2	1	6	6
Permitted Phases							
Actuated Green, G (s)	15.5	15.5	3.5	92.5		83.0	83.0
Effective Green, g (s)	15.5	15.5	3.5	92.5		83.0	83.0
Actuated g/C Ratio	0.13	0.13	0.03	0.77		0.69	0.69
Clearance Time (s)	6.0	6.0	6.0	6.0		6.0	6.0
Vehicle Extension (s)	3.5	3.5	3.5	4.0		4.0	4.0
Lane Grp Cap (vph)	233	184	37	2727		2424	1084
v/s Ratio Prot	c0.09	0.00	0.01	c0.61		0.34	0.02
v/s Ratio Perm							
v/c Ratio	0.67	0.03	0.49	0.80		0.50	0.02
Uniform Delay, d1	49.8	45.7	57.4	8.2		8.7	5.8
Progression Factor	1.00	1.00	1.00	1.00		1.00	1.00
Incremental Delay, d2	7.3	0.1	11.4	2.5		0.7	0.0
Delay (s)	57.0	45.8	68.8	10.7		9.4	5.8
Level of Service	E	D	E	B		A	A
Approach Delay (s)	54.3			11.2		9.3	
Approach LOS	D			B		A	

Intersection Summary

HCM 2000 Control Delay	13.0	HCM 2000 Level of Service	B
HCM 2000 Volume to Capacity ratio	0.82		
Actuated Cycle Length (s)	120.0	Sum of lost time (s)	18.0
Intersection Capacity Utilization	75.9%	ICU Level of Service	D
Analysis Period (min)	15		
c Critical Lane Group			

HCM Unsignalized Intersection Capacity Analysis
 15: US 29 (S) & U-Turn Access

05/31/2021



Movement	WBL	WBR	NBT	NBR	SBL	SBT
Lane Configurations	↶					↷↷
Traffic Volume (veh/h)	17	0	0	0	0	1285
Future Volume (Veh/h)	17	0	0	0	0	1285
Sign Control	Stop		Free			Free
Grade	0%		0%			0%
Peak Hour Factor	0.92	0.92	0.92	0.92	0.92	0.92
Hourly flow rate (vph)	18	0	0	0	0	1397
Pedestrians						
Lane Width (ft)						
Walking Speed (ft/s)						
Percent Blockage						
Right turn flare (veh)						
Median type			None			None
Median storage (veh)						
Upstream signal (ft)						
pX, platoon unblocked						
vC, conflicting volume	698	0			0	
vC1, stage 1 conf vol						
vC2, stage 2 conf vol						
vCu, unblocked vol	698	0			0	
tC, single (s)	6.8	6.9			4.1	
tC, 2 stage (s)						
tF (s)	3.5	3.3			2.2	
p0 queue free %	95	100			100	
cM capacity (veh/h)	374	1084			1622	
Direction, Lane #	WB 1	SB 1	SB 2			
Volume Total	18	698	698			
Volume Left	18	0	0			
Volume Right	0	0	0			
cSH	374	1700	1700			
Volume to Capacity	0.05	0.41	0.41			
Queue Length 95th (ft)	4	0	0			
Control Delay (s)	15.1	0.0	0.0			
Lane LOS	C					
Approach Delay (s)	15.1	0.0				
Approach LOS	C					
Intersection Summary						
Average Delay			0.2			
Intersection Capacity Utilization			101.0%		ICU Level of Service	G
Analysis Period (min)			15			

HCM Unsignalized Intersection Capacity Analysis
 16: US 29 (N) & U-Turn Access

05/31/2021



Movement	EBL	EBR	NBL	NBT	SBT	SBR
Lane Configurations						
Traffic Volume (veh/h)	0	0	17	2127	0	0
Future Volume (Veh/h)	0	0	17	2127	0	0
Sign Control	Stop			Free	Free	
Grade	0%			0%	0%	
Peak Hour Factor	0.92	0.92	0.92	0.92	0.92	0.92
Hourly flow rate (vph)	0	0	18	2312	0	0
Pedestrians						
Lane Width (ft)						
Walking Speed (ft/s)						
Percent Blockage						
Right turn flare (veh)						
Median type			None	None		
Median storage (veh)						
Upstream signal (ft)						
pX, platoon unblocked						
vC, conflicting volume	1192	0	0			
vC1, stage 1 conf vol						
vC2, stage 2 conf vol						
vCu, unblocked vol	1192	0	0			
tC, single (s)	6.8	6.9	4.1			
tC, 2 stage (s)						
tF (s)	3.5	3.3	2.2			
p0 queue free %	100	100	99			
cM capacity (veh/h)	178	1084	1622			
Direction, Lane #	NB 1	NB 2	NB 3			
Volume Total	18	1156	1156			
Volume Left	18	0	0			
Volume Right	0	0	0			
cSH	1622	1700	1700			
Volume to Capacity	0.01	0.68	0.68			
Queue Length 95th (ft)	1	0	0			
Control Delay (s)	7.2	0.0	0.0			
Lane LOS	A					
Approach Delay (s)	0.1					
Approach LOS						
Intersection Summary						
Average Delay			0.1			
Intersection Capacity Utilization			101.0%	ICU Level of Service	G	
Analysis Period (min)			15			

HCM Unsignalized Intersection Capacity Analysis
 17: US 29 (S)

















05/31/2021



Movement	WBL	WBR	NBT	NBR	SBL	SBT
Lane Configurations					↘	↕↕
Traffic Volume (veh/h)	0	0	0	0	18	1244
Future Volume (Veh/h)	0	0	0	0	18	1244
Sign Control	Stop		Free			Free
Grade	0%		0%			0%
Peak Hour Factor	0.92	0.92	0.92	0.92	0.92	0.92
Hourly flow rate (vph)	0	0	0	0	20	1352
Pedestrians						
Lane Width (ft)						
Walking Speed (ft/s)						
Percent Blockage						
Right turn flare (veh)						
Median type	None			None		
Median storage (veh)						
Upstream signal (ft)						
pX, platoon unblocked						
vC, conflicting volume	716	0			0	
vC1, stage 1 conf vol						
vC2, stage 2 conf vol						
vCu, unblocked vol	716	0			0	
tC, single (s)	6.8	6.9			4.1	
tC, 2 stage (s)						
tF (s)	3.5	3.3			2.2	
p0 queue free %	100	100			99	
cM capacity (veh/h)	360	1084			1622	
Direction, Lane #	SB 1	SB 2	SB 3			
Volume Total	20	676	676			
Volume Left	20	0	0			
Volume Right	0	0	0			
cSH	1622	1700	1700			
Volume to Capacity	0.01	0.40	0.40			
Queue Length 95th (ft)	1	0	0			
Control Delay (s)	7.2	0.0	0.0			
Lane LOS	A					
Approach Delay (s)	0.1					
Approach LOS						
Intersection Summary						
Average Delay	0.1					
Intersection Capacity Utilization	60.2%		ICU Level of Service		B	
Analysis Period (min)	15					

















HCM Unsignalized Intersection Capacity Analysis
 18: US 29 (N) & Northside Dr E

05/31/2021

												
Movement	EBL	EBT	EBR	WBL	WBT	WBR	NBL	NBT	NBR	SBL	SBT	SBR
Lane Configurations								 				
Traffic Volume (veh/h)	17	0	0	0	0	7	0	1892	2	0	0	0
Future Volume (Veh/h)	17	0	0	0	0	7	0	1892	2	0	0	0
Sign Control		Stop			Stop			Free			Free	
Grade		0%			0%			0%			0%	
Peak Hour Factor	0.92	0.92	0.92	0.92	0.92	0.92	0.92	0.92	0.92	0.92	0.92	0.92
Hourly flow rate (vph)	18	0	0	0	0	8	0	2057	2	0	0	0
Pedestrians												
Lane Width (ft)												
Walking Speed (ft/s)												
Percent Blockage												
Right turn flare (veh)												
Median type												
								None			None	
Median storage (veh)												
Upstream signal (ft)												
pX, platoon unblocked												
vC, conflicting volume	1036	2059	0	2057	2057	1028	0			2059		
vC1, stage 1 conf vol												
vC2, stage 2 conf vol												
vCu, unblocked vol	1036	2059	0	2057	2057	1028	0			2059		
tC, single (s)	7.5	6.5	6.9	7.5	6.5	6.9	4.1			4.1		
tC, 2 stage (s)												
tF (s)	3.5	4.0	3.3	3.5	4.0	3.3	2.2			2.2		
p0 queue free %	90	100	100	100	100	97	100			100		
cM capacity (veh/h)	179	54	1084	32	54	231	1622			268		
Direction, Lane #	EB 1	WB 1	NB 1	NB 2	NB 3							
Volume Total	18	8	1028	1028	2							
Volume Left	18	0	0	0	0							
Volume Right	0	8	0	0	2							
cSH	179	231	1700	1700	1700							
Volume to Capacity	0.10	0.03	0.60	0.60	0.00							
Queue Length 95th (ft)	8	3	0	0	0							
Control Delay (s)	27.3	21.1	0.0	0.0	0.0							
Lane LOS	D	C										
Approach Delay (s)	27.3	21.1	0.0									
Approach LOS	D	C										
Intersection Summary												
Average Delay			0.3									
Intersection Capacity Utilization			69.0%		ICU Level of Service					C		
Analysis Period (min)			15									

HCM Unsignalized Intersection Capacity Analysis
 19: US 29 (S) & Northside Dr W

05/31/2021

												
Movement	EBL	EBT	EBR	WBL	WBT	WBR	NBL	NBT	NBR	SBL	SBT	SBR
Lane Configurations												
Traffic Volume (veh/h)	0	0	17	0	5	0	0	0	0	0	1240	4
Future Volume (Veh/h)	0	0	17	0	5	0	0	0	0	0	1240	4
Sign Control		Stop			Stop			Free			Free	
Grade		0%			0%			0%			0%	
Peak Hour Factor	0.92	0.92	0.92	0.92	0.92	0.92	0.92	0.92	0.92	0.92	0.92	0.92
Hourly flow rate (vph)	0	0	18	0	5	0	0	0	0	0	1348	4
Pedestrians												
Lane Width (ft)												
Walking Speed (ft/s)												
Percent Blockage												
Right turn flare (veh)												
Median type												
Median storage veh												
Upstream signal (ft)												
pX, platoon unblocked												
vC, conflicting volume	1350	1348	674	692	1352	0	1352			0		
vC1, stage 1 conf vol												
vC2, stage 2 conf vol												
vCu, unblocked vol	1350	1348	674	692	1352	0	1352			0		
tC, single (s)	7.5	6.5	6.9	7.5	6.5	6.9	4.1			4.1		
tC, 2 stage (s)												
tF (s)	3.5	4.0	3.3	3.5	4.0	3.3	2.2			2.2		
p0 queue free %	100	100	95	100	97	100	100			100		
cM capacity (veh/h)	106	150	397	315	149	1084	505			1622		
Direction, Lane #	EB 1	WB 1	SB 1	SB 2	SB 3							
Volume Total	18	5	674	674	4							
Volume Left	0	0	0	0	0							
Volume Right	18	0	0	0	4							
cSH	397	149	1700	1700	1700							
Volume to Capacity	0.05	0.03	0.40	0.40	0.00							
Queue Length 95th (ft)	4	3	0	0	0							
Control Delay (s)	14.5	30.0	0.0	0.0	0.0							
Lane LOS	B	D										
Approach Delay (s)	14.5	30.0	0.0									
Approach LOS	B	D										
Intersection Summary												
Average Delay			0.3									
Intersection Capacity Utilization			55.7%		ICU Level of Service					B		
Analysis Period (min)			15									

HCM Unsignalized Intersection Capacity Analysis
 20: US 29 (N) & Northside Dr W

05/31/2021



Movement	EBL	EBR	NBL	NBT	SBT	SBR
Lane Configurations			↵	↑↑		
Traffic Volume (veh/h)	0	0	5	1894	0	0
Future Volume (Veh/h)	0	0	5	1894	0	0
Sign Control	Stop			Free	Free	
Grade	0%			0%	0%	
Peak Hour Factor	0.92	0.92	0.92	0.92	0.92	0.92
Hourly flow rate (vph)	0	0	5	2059	0	0
Pedestrians						
Lane Width (ft)						
Walking Speed (ft/s)						
Percent Blockage						
Right turn flare (veh)						
Median type				None	None	
Median storage (veh)						
Upstream signal (ft)						
pX, platoon unblocked						
vC, conflicting volume	1040	0	0			
vC1, stage 1 conf vol						
vC2, stage 2 conf vol						
vCu, unblocked vol	1040	0	0			
tC, single (s)	6.8	6.9	4.1			
tC, 2 stage (s)						
tF (s)	3.5	3.3	2.2			
p0 queue free %	100	100	100			
cM capacity (veh/h)	225	1084	1622			
Direction, Lane #	NB 1	NB 2	NB 3			
Volume Total	5	1030	1030			
Volume Left	5	0	0			
Volume Right	0	0	0			
cSH	1622	1700	1700			
Volume to Capacity	0.00	0.61	0.61			
Queue Length 95th (ft)	0	0	0			
Control Delay (s)	7.2	0.0	0.0			
Lane LOS	A					
Approach Delay (s)	0.0					
Approach LOS						
Intersection Summary						
Average Delay	0.0					
Intersection Capacity Utilization	55.7%			ICU Level of Service	B	
Analysis Period (min)	15					

HCM Unsignalized Intersection Capacity Analysis
 21: Airport Acres Rd (South) E & US 29 (S)

05/31/2021



Movement	WBL	WBR	NBT	NBR	SBL	SBT
Lane Configurations					↘	↕↕
Traffic Volume (veh/h)	0	0	0	0	7	1283
Future Volume (Veh/h)	0	0	0	0	7	1283
Sign Control	Stop		Free			Free
Grade	0%		0%			0%
Peak Hour Factor	0.92	0.92	0.92	0.92	0.92	0.92
Hourly flow rate (vph)	0	0	0	0	8	1395
Pedestrians						
Lane Width (ft)						
Walking Speed (ft/s)						
Percent Blockage						
Right turn flare (veh)						
Median type	None			None		
Median storage (veh)						
Upstream signal (ft)						
pX, platoon unblocked						
vC, conflicting volume	714	0			0	
vC1, stage 1 conf vol						
vC2, stage 2 conf vol						
vCu, unblocked vol	714	0			0	
tC, single (s)	6.8	6.9			4.1	
tC, 2 stage (s)						
tF (s)	3.5	3.3			2.2	
p0 queue free %	100	100			100	
cM capacity (veh/h)	364	1084			1622	
Direction, Lane #	SB 1	SB 2	SB 3			
Volume Total	8	698	698			
Volume Left	8	0	0			
Volume Right	0	0	0			
cSH	1622	1700	1700			
Volume to Capacity	0.00	0.41	0.41			
Queue Length 95th (ft)	0	0	0			
Control Delay (s)	7.2	0.0	0.0			
Lane LOS	A					
Approach Delay (s)	0.0					
Approach LOS						
Intersection Summary						
Average Delay			0.0			
Intersection Capacity Utilization			70.0%	ICU Level of Service		C
Analysis Period (min)			15			

HCM Unsignalized Intersection Capacity Analysis
 22: Airport Acres Rd (South) E & US 29 (N)

06/07/2021



Movement	EBL	EBR	NBL	NBT	SBT	SBR
Lane Configurations	↶			↷		
Traffic Volume (veh/h)	7	0	0	2063	0	0
Future Volume (Veh/h)	7	0	0	2063	0	0
Sign Control	Stop			Free	Free	
Grade	0%			0%	0%	
Peak Hour Factor	0.92	0.92	0.92	0.92	0.92	0.92
Hourly flow rate (vph)	8	0	0	2242	0	0
Pedestrians						
Lane Width (ft)						
Walking Speed (ft/s)						
Percent Blockage						
Right turn flare (veh)						
Median type				None	None	
Median storage (veh)						
Upstream signal (ft)						
pX, platoon unblocked						
vC, conflicting volume	1121	0	0			
vC1, stage 1 conf vol						
vC2, stage 2 conf vol						
vCu, unblocked vol	1121	0	0			
tC, single (s)	6.8	6.9	4.1			
tC, 2 stage (s)						
tF (s)	3.5	3.3	2.2			
p0 queue free %	96	100	100			
cM capacity (veh/h)	200	1084	1622			
Direction, Lane #	EB 1	NB 1	NB 2			
Volume Total	8	1121	1121			
Volume Left	8	0	0			
Volume Right	0	0	0			
cSH	200	1700	1700			
Volume to Capacity	0.04	0.66	0.66			
Queue Length 95th (ft)	3	0	0			
Control Delay (s)	23.7	0.0	0.0			
Lane LOS	C					
Approach Delay (s)	23.7	0.0				
Approach LOS	C					
Intersection Summary						
Average Delay			0.1			
Intersection Capacity Utilization			67.0%	ICU Level of Service	C	
Analysis Period (min)			15			

HCM Unsignalized Intersection Capacity Analysis
 23: US 29 (S) & Airport Acres Rd (North) W

05/31/2021



Movement	EBL	EBT	EBR	WBL	WBT	WBR	NBL	NBT	NBR	SBL	SBT	SBR
Lane Configurations			↗		↖						↕	↘
Traffic Volume (veh/h)	0	0	0	0	7	0	0	0	0	0	1279	4
Future Volume (Veh/h)	0	0	0	0	7	0	0	0	0	0	1279	4
Sign Control		Stop			Stop			Free			Free	
Grade		0%			0%			0%			0%	
Peak Hour Factor	0.92	0.92	0.92	0.92	0.92	0.92	0.92	0.92	0.92	0.92	0.92	0.92
Hourly flow rate (vph)	0	0	0	0	8	0	0	0	0	0	1390	4
Pedestrians												
Lane Width (ft)												
Walking Speed (ft/s)												
Percent Blockage												
Right turn flare (veh)												
Median type								None			None	
Median storage (veh)												
Upstream signal (ft)												
pX, platoon unblocked												
vC, conflicting volume	1396	1392	697	695	1394	0	1394			0		
vC1, stage 1 conf vol												
vC2, stage 2 conf vol												
vCu, unblocked vol	1396	1392	697	695	1394	0	1394			0		
tC, single (s)	7.5	6.5	6.9	7.5	6.5	6.9	4.1			4.1		
tC, 2 stage (s)												
tF (s)	3.5	4.0	3.3	3.5	4.0	3.3	2.2			2.2		
p0 queue free %	100	100	100	100	94	100	100			100		
cM capacity (veh/h)	96	141	383	329	140	1084	487			1622		
Direction, Lane #	EB 1	WB 1	SB 1	SB 2								
Volume Total	0	8	927	467								
Volume Left	0	0	0	0								
Volume Right	0	0	0	4								
cSH	1700	140	1700	1700								
Volume to Capacity	0.00	0.06	0.55	0.27								
Queue Length 95th (ft)	0	4	0	0								
Control Delay (s)	0.0	32.2	0.0	0.0								
Lane LOS	A	D										
Approach Delay (s)	0.0	32.2	0.0									
Approach LOS	A	D										
Intersection Summary												
Average Delay			0.2									
Intersection Capacity Utilization			60.4%		ICU Level of Service					B		
Analysis Period (min)			15									

HCM Unsignalized Intersection Capacity Analysis

24: US 29 (N)

05/31/2021



Movement	EBL	EBR	NBL	NBT	SBT	SBR
Lane Configurations						
Traffic Volume (veh/h)	0	0	7	2063	0	0
Future Volume (Veh/h)	0	0	7	2063	0	0
Sign Control	Stop			Free	Free	
Grade	0%			0%	0%	
Peak Hour Factor	0.92	0.92	0.92	0.92	0.92	0.92
Hourly flow rate (vph)	0	0	8	2242	0	0
Pedestrians						
Lane Width (ft)						
Walking Speed (ft/s)						
Percent Blockage						
Right turn flare (veh)						
Median type				None	None	
Median storage (veh)						
Upstream signal (ft)						
pX, platoon unblocked						
vC, conflicting volume	1137	0	0			
vC1, stage 1 conf vol						
vC2, stage 2 conf vol						
vCu, unblocked vol	1137	0	0			
tC, single (s)	6.8	6.9	4.1			
tC, 2 stage (s)						
tF (s)	3.5	3.3	2.2			
p0 queue free %	100	100	100			
cM capacity (veh/h)	194	1084	1622			
Direction, Lane #	NB 1	NB 2	NB 3			
Volume Total	8	1121	1121			
Volume Left	8	0	0			
Volume Right	0	0	0			
cSH	1622	1700	1700			
Volume to Capacity	0.00	0.66	0.66			
Queue Length 95th (ft)	0	0	0			
Control Delay (s)	7.2	0.0	0.0			
Lane LOS	A					
Approach Delay (s)	0.0					
Approach LOS						
Intersection Summary						
Average Delay	0.0					
Intersection Capacity Utilization	60.4%			ICU Level of Service	B	
Analysis Period (min)	15					

HCM Unsignalized Intersection Capacity Analysis
 25: US 29 & Airport Acres Rd South

05/31/2021



Movement	EBL	EBR	NBL	NBT	SBT	SBR
Lane Configurations	W		W	↑↑	↑↑	
Traffic Volume (veh/h)	1	7	19	2082	1286	0
Future Volume (Veh/h)	1	7	19	2082	1286	0
Sign Control	Stop			Free	Free	
Grade	0%			0%	0%	
Peak Hour Factor	0.97	0.97	0.97	0.97	0.97	0.97
Hourly flow rate (vph)	1	7	20	2146	1326	0
Pedestrians						
Lane Width (ft)						
Walking Speed (ft/s)						
Percent Blockage						
Right turn flare (veh)						
Median type				Raised	Raised	
Median storage (veh)				2	2	
Upstream signal (ft)				872		
pX, platoon unblocked	0.52					
vC, conflicting volume	2439	663	1326			
vC1, stage 1 conf vol	1326					
vC2, stage 2 conf vol	1113					
vCu, unblocked vol	1926	663	1326			
tC, single (s)	6.8	7.1	4.1			
tC, 2 stage (s)	5.8					
tF (s)	3.5	3.4	2.2			
p0 queue free %	99	98	96			
cM capacity (veh/h)	194	385	527			
Direction, Lane #	EB 1	NB 1	NB 2	NB 3	SB 1	SB 2
Volume Total	8	20	1073	1073	663	663
Volume Left	1	20	0	0	0	0
Volume Right	7	0	0	0	0	0
cSH	343	527	1700	1700	1700	1700
Volume to Capacity	0.02	0.04	0.63	0.63	0.39	0.39
Queue Length 95th (ft)	2	3	0	0	0	0
Control Delay (s)	15.7	12.1	0.0	0.0	0.0	0.0
Lane LOS	C	B				
Approach Delay (s)	15.7	0.1	0.0			
Approach LOS	C					
Intersection Summary						
Average Delay			0.1			
Intersection Capacity Utilization			67.6%	ICU Level of Service	C	
Analysis Period (min)			15			

Queues

26: US 29 & Airport Road

05/31/2021



Lane Group	EBL	EBT	EBR	WBL	WBT	NBL	NBT	NBR	SBL	SBT	SBR
Lane Group Flow (vph)	122	86	160	117	212	89	1903	154	160	1121	89
v/c Ratio	0.56	0.54	0.23	0.73	0.85	0.49	1.12	0.14	0.86	0.60	0.08
Control Delay	69.1	69.5	9.1	83.1	67.9	69.6	95.3	1.6	95.4	22.5	1.2
Queue Delay	0.0	0.0	0.0	0.0	0.0	0.0	0.0	0.0	0.0	0.0	0.0
Total Delay	69.1	69.5	9.1	83.1	67.9	69.6	95.3	1.6	95.4	22.5	1.2
Queue Length 50th (ft)	52	70	5	97	123	38	~992	0	135	337	0
Queue Length 95th (ft)	86	126	37	#182	#247	67	#1130	24	#263	407	14
Internal Link Dist (ft)		677			627		911			792	
Turn Bay Length (ft)	425		450	570		575		430	475		540
Base Capacity (vph)	226	172	651	172	269	182	1698	1078	188	1868	1074
Starvation Cap Reductn	0	0	0	0	0	0	0	0	0	0	0
Spillback Cap Reductn	0	0	0	0	0	0	0	0	0	0	0
Storage Cap Reductn	0	0	0	0	0	0	0	0	0	0	0
Reduced v/c Ratio	0.54	0.50	0.25	0.68	0.79	0.49	1.12	0.14	0.85	0.60	0.08

Intersection Summary

~ Volume exceeds capacity, queue is theoretically infinite.





























Queue shown is maximum after two cycles.

95th percentile volume exceeds capacity, queue may be longer.

Queue shown is maximum after two cycles.

HCM Signalized Intersection Capacity Analysis
 26: US 29 & Airport Road

05/31/2021























												
Movement	EBL	EBT	EBR	WBL	WBT	WBR	NBL	NBT	NBR	SBL	SBT	SBR
Lane Configurations	 		 				 	 			 	
Traffic Volume (vph)	117	83	154	112	67	136	85	1827	148	154	1076	85
Future Volume (vph)	117	83	154	112	67	136	85	1827	148	154	1076	85
Ideal Flow (vphpl)	1900	1900	1900	1900	1900	1900	1900	1900	1900	1900	1900	1900
Total Lost time (s)	10.5	6.7	6.7	9.1	5.6		8.3	5.7	5.7	8.1	5.7	5.7
Lane Util. Factor	0.97	1.00	0.88	1.00	1.00		0.97	0.95	1.00	1.00	0.95	1.00
Frt	1.00	1.00	0.85	1.00	0.90		1.00	1.00	0.85	1.00	1.00	0.85
Flt Protected	0.95	1.00	1.00	0.95	1.00		0.95	1.00	1.00	0.95	1.00	1.00
Satd. Flow (prot)	3467	1827	2787	1736	1692		3433	3505	1568	1719	3471	1524
Flt Permitted	0.95	1.00	1.00	0.95	1.00		0.95	1.00	1.00	0.95	1.00	1.00
Satd. Flow (perm)	3467	1827	2787	1736	1692		3433	3505	1568	1719	3471	1524
Peak-hour factor, PHF	0.96	0.96	0.96	0.96	0.96	0.96	0.96	0.96	0.96	0.96	0.96	0.96
Adj. Flow (vph)	122	86	160	117	70	142	89	1903	154	160	1121	89
RTOR Reduction (vph)	0	0	119	0	57	0	0	0	58	0	0	32
Lane Group Flow (vph)	122	86	41	117	155	0	89	1903	96	160	1121	57
Heavy Vehicles (%)	1%	4%	2%	4%	3%	0%	2%	3%	3%	5%	4%	6%
Turn Type	Prot	NA	pt+ov	Prot	NA		Prot	NA	pt+ov	Prot	NA	pt+ov
Protected Phases	7	4	4 5	3	8		5	2	2 3	1	6	6 7
Permitted Phases												
Actuated Green, G (s)	8.2	11.4	25.0	12.0	14.9		6.9	63.0	80.7	14.0	69.9	83.8
Effective Green, g (s)	8.2	11.4	25.0	12.0	14.9		6.9	63.0	80.7	14.0	69.9	83.8
Actuated g/C Ratio	0.06	0.09	0.19	0.09	0.11		0.05	0.48	0.62	0.11	0.54	0.64
Clearance Time (s)	10.5	6.7		9.1	5.6		8.3	5.7		8.1	5.7	
Vehicle Extension (s)	3.0	3.0		3.0	3.0		3.0	3.0		3.0	3.0	
Lane Grp Cap (vph)	218	160	535	160	193		182	1698	973	185	1866	982
v/s Ratio Prot	0.04	0.05	0.01	c0.07	c0.09		0.03	c0.54	0.06	c0.09	c0.32	0.04
v/s Ratio Perm												
v/c Ratio	0.56	0.54	0.08	0.73	0.80		0.49	1.12	0.10	0.86	0.60	0.06
Uniform Delay, d1	59.1	56.8	43.0	57.4	56.1		59.8	33.5	10.0	57.1	20.5	8.5
Progression Factor	1.00	1.00	1.00	1.00	1.00		1.00	1.00	1.00	1.00	1.00	1.00
Incremental Delay, d2	3.1	3.4	0.1	15.8	21.1		2.1	62.8	0.0	31.7	1.4	0.0
Delay (s)	62.2	60.2	43.1	73.2	77.2		61.9	96.3	10.0	88.8	22.0	8.6
Level of Service	E	E	D	E	E		E	F	A	F	C	A
Approach Delay (s)		53.5			75.8			88.7			28.9	
Approach LOS		D			E			F			C	
Intersection Summary												
HCM 2000 Control Delay			65.2				HCM 2000 Level of Service				E	
HCM 2000 Volume to Capacity ratio			1.05									
Actuated Cycle Length (s)			130.0				Sum of lost time (s)			30.1		
Intersection Capacity Utilization			97.0%				ICU Level of Service			F		
Analysis Period (min)			15									
c Critical Lane Group												

Attachment C Future
No-Build
Traffic
Conditions
Analysis

HCM Unsignalized Intersection Capacity Analysis

1: US 29 & Deerfield Drive

07/22/2021

													
Movement	EBL	EBT	EBR	WBL	WBT	WBR	NBL	NBT	NBR	SBL	SBT	SBR	
Lane Configurations													
Traffic Volume (veh/h)	13	1	31	1	0	0	15	871	0	0	1518	21	
Future Volume (Veh/h)	13	1	31	1	0	0	15	871	0	0	1518	21	
Sign Control		Stop			Stop			Free			Free		
Grade		0%			0%			0%			0%		
Peak Hour Factor	0.92	0.92	0.92	0.92	0.92	0.92	0.92	0.92	0.92	0.92	0.92	0.92	
Hourly flow rate (vph)	14	1	34	1	0	0	16	947	0	0	1650	23	
Pedestrians													
Lane Width (ft)													
Walking Speed (ft/s)													
Percent Blockage													
Right turn flare (veh)													
Median type													
Median storage (veh)													
Upstream signal (ft)													
pX, platoon unblocked	0.85	0.85		0.85	0.85	0.85					0.85		
vC, conflicting volume	2156	2629	825	1804	2652	474	1673				947		
vC1, stage 1 conf vol	1650	1650		979	979								
vC2, stage 2 conf vol	506	979		826	1673								
vCu, unblocked vol	2011	2566	825	1600	2593	42	1673				596		
tC, single (s)	7.5	6.5	7.1	7.5	6.5	6.9	4.3				4.1		
tC, 2 stage (s)	6.5	5.5		6.5	5.5								
tF (s)	3.5	4.0	3.4	3.5	4.0	3.3	2.3				2.2		
p0 queue free %	86	99	89	100	100	100	95				100		
cM capacity (veh/h)	102	142	298	220	126	876	354				846		
Direction, Lane #	EB 1	WB 1	NB 1	NB 2	NB 3	NB 4	SB 1	SB 2	SB 3	SB 4			
Volume Total	49	1	16	474	474	0	0	825	825	23			
Volume Left	14	1	16	0	0	0	0	0	0	0			
Volume Right	34	0	0	0	0	0	0	0	0	23			
cSH	341	220	354	1700	1700	1700	1700	1700	1700	1700			
Volume to Capacity	0.14	0.00	0.05	0.28	0.28	0.00	0.00	0.49	0.49	0.01			
Queue Length 95th (ft)	12	0	4	0	0	0	0	0	0	0			
Control Delay (s)	26.8	21.4	15.7	0.0	0.0	0.0	0.0	0.0	0.0	0.0			
Lane LOS	D	C	C										
Approach Delay (s)	26.8	21.4	0.3										
Approach LOS	D	C											
Intersection Summary													
Average Delay			0.6										
Intersection Capacity Utilization			58.6%	ICU Level of Service						B			
Analysis Period (min)			15										

Queues

2: US 29 & Matthew Mill Road

07/22/2021



Lane Group	EBT	EBR	WBL	WBT	WBR	NBL	NBT	NBR	SBL	SBT	SBR
Lane Group Flow (vph)	150	216	174	178	57	84	712	99	68	1570	21
v/c Ratio	0.94	0.62	0.91	0.92	0.18	0.75	0.48	0.13	0.52	0.98	0.03
Control Delay	106.7	21.5	93.5	96.6	1.2	79.2	33.2	6.3	62.4	47.7	0.1
Queue Delay	0.0	0.0	0.0	0.0	0.0	0.0	0.0	0.0	0.0	0.0	0.0
Total Delay	106.7	21.5	93.5	96.6	1.2	79.2	33.2	6.3	62.4	47.7	0.1
Queue Length 50th (ft)	107	34	129	132	0	56	236	10	46	557	0
Queue Length 95th (ft)	#234	112	#266	#274	0	#136	297	28	93	#733	0
Internal Link Dist (ft)	263			737			534			690	
Turn Bay Length (ft)			600		575	300		355	625		
Base Capacity (vph)	159	347	192	193	320	112	1492	784	145	1605	784
Starvation Cap Reductn	0	0	0	0	0	0	0	0	0	0	0
Spillback Cap Reductn	0	0	0	0	0	0	0	0	0	0	0
Storage Cap Reductn	0	0	0	0	0	0	0	0	0	0	0
Reduced v/c Ratio	0.94	0.62	0.91	0.92	0.18	0.75	0.48	0.13	0.47	0.98	0.03























Intersection Summary

95th percentile volume exceeds capacity, queue may be longer.
 Queue shown is maximum after two cycles.

HCM Signalized Intersection Capacity Analysis

2: US 29 & Matthew Mill Road

07/22/2021

													
Movement	EBL	EBT	EBR	WBL	WBT	WBR	NBL	NBT	NBR	SBL	SBT	SBR	
Lane Configurations													
Traffic Volume (vph)	91	47	199	291	33	52	77	655	91	63	1444	19	
Future Volume (vph)	91	47	199	291	33	52	77	655	91	63	1444	19	
Ideal Flow (vphpl)	1900	1900	1900	1900	1900	1900	1900	1900	1900	1900	1900	1900	
Total Lost time (s)		6.5	6.5	6.5	6.5	6.5	6.0	7.0	7.0	6.0	7.0	7.0	
Lane Util. Factor		1.00	1.00	0.95	0.95	1.00	1.00	0.95	1.00	1.00	0.95	1.00	
Frt		1.00	0.85	1.00	1.00	0.85	1.00	1.00	0.85	1.00	1.00	0.85	
Flt Protected		0.97	1.00	0.95	0.96	1.00	0.95	1.00	1.00	0.95	1.00	1.00	
Satd. Flow (prot)		1746	1599	1698	1702	1538	1770	3223	1509	1597	3505	1524	
Flt Permitted		0.69	1.00	0.95	0.96	1.00	0.95	1.00	1.00	0.95	1.00	1.00	
Satd. Flow (perm)		1247	1599	1698	1702	1538	1770	3223	1509	1597	3505	1524	
Peak-hour factor, PHF	0.92	0.92	0.92	0.92	0.92	0.92	0.92	0.92	0.92	0.92	0.92	0.92	
Adj. Flow (vph)	99	51	216	316	36	57	84	712	99	68	1570	21	
RTOR Reduction (vph)	0	0	143	0	0	51	0	0	54	0	0	11	
Lane Group Flow (vph)	0	150	73	174	178	6	84	712	45	68	1570	10	
Heavy Vehicles (%)	6%	4%	1%	1%	6%	5%	2%	12%	7%	13%	3%	6%	
Turn Type	Perm	NA	Prot	Split	NA	Prot	Prot	NA	Prot	Prot	NA	Prot	
Protected Phases		4	4	3	3	3	5	2	2	1	6	6	
Permitted Phases	4												
Actuated Green, G (s)		14.1	14.1	12.5	12.5	12.5	7.0	49.7	49.7	7.7	50.4	50.4	
Effective Green, g (s)		14.1	14.1	12.5	12.5	12.5	7.0	49.7	49.7	7.7	50.4	50.4	
Actuated g/C Ratio		0.13	0.13	0.11	0.11	0.11	0.06	0.45	0.45	0.07	0.46	0.46	
Clearance Time (s)		6.5	6.5	6.5	6.5	6.5	6.0	7.0	7.0	6.0	7.0	7.0	
Vehicle Extension (s)		3.0	3.0	3.0	3.0	3.0	3.0	6.0	6.0	3.0	6.0	6.0	
Lane Grp Cap (vph)		159	204	192	193	174	112	1456	681	111	1605	698	
v/s Ratio Prot			0.05	0.10	c0.10	0.00	c0.05	0.22	0.03	0.04	c0.45	0.01	
v/s Ratio Perm		c0.12											
v/c Ratio		0.94	0.36	0.91	0.92	0.04	0.75	0.49	0.07	0.61	0.98	0.01	
Uniform Delay, d1		47.6	43.8	48.2	48.3	43.4	50.6	21.2	17.0	49.7	29.3	16.2	
Progression Factor		1.00	1.00	1.00	1.00	1.00	0.83	1.49	12.57	1.00	1.00	1.00	
Incremental Delay, d2		54.4	1.1	39.4	43.2	0.1	23.6	1.1	0.2	9.6	17.8	0.0	
Delay (s)		102.0	44.9	87.5	91.5	43.5	65.4	32.8	214.3	59.3	47.1	16.3	
Level of Service		F	D	F	F	D	E	C	F	E	D	B	
Approach Delay (s)		68.3			83.1			55.9			47.2		
Approach LOS		E			F			E			D		
Intersection Summary													
HCM 2000 Control Delay			56.3		HCM 2000 Level of Service						E		
HCM 2000 Volume to Capacity ratio			0.94										
Actuated Cycle Length (s)			110.0		Sum of lost time (s)					26.0			
Intersection Capacity Utilization			77.8%		ICU Level of Service					D			
Analysis Period (min)			15										
c Critical Lane Group													

Queues

3: US 29 & Heatherton Drive

07/22/2021



Lane Group	EBT	EBR	WBR	NBL	NBT	SBT	SBR
Lane Group Flow (vph)	5	49	21	76	897	2031	5
v/c Ratio	0.05	0.25	0.07	0.46	0.31	0.74	0.00
Control Delay	0.0	3.1	0.4	48.1	1.3	3.4	0.0
Queue Delay	0.0	0.0	0.0	0.0	0.0	0.4	0.0
Total Delay	0.0	3.1	0.4	48.1	1.3	3.9	0.0
Queue Length 50th (ft)	0	0	0	54	25	62	0
Queue Length 95th (ft)	0	0	0	m89	m65	m92	m0
Internal Link Dist (ft)	96				1998	534	
Turn Bay Length (ft)				550			
Base Capacity (vph)	104	367	473	169	2931	2738	1275
Starvation Cap Reductn	0	0	0	0	0	270	0
Spillback Cap Reductn	0	0	0	0	0	0	0
Storage Cap Reductn	0	0	0	0	0	0	0
Reduced v/c Ratio	0.05	0.13	0.04	0.45	0.31	0.82	0.00



















Intersection Summary

m Volume for 95th percentile queue is metered by upstream signal.

HCM Signalized Intersection Capacity Analysis

3: US 29 & Heatherton Drive



















07/22/2021

												
Movement	EBL	EBT	EBR	WBL	WBT	WBR	NBL	NBT	NBR	SBL	SBT	SBR
Lane Configurations												
Traffic Volume (vph)	0	0	51	0	0	20	72	823	29	0	1929	5
Future Volume (vph)	0	0	51	0	0	20	72	823	29	0	1929	5
Ideal Flow (vphpl)	1900	1900	1900	1900	1900	1900	1900	1900	1900	1900	1900	1900
Total Lost time (s)		4.0	4.5			4.5	4.5	4.5			4.5	4.5
Lane Util. Factor		1.00	1.00			1.00	1.00	0.95			0.95	1.00
Frt		0.86	0.86			0.86	1.00	0.99			1.00	0.85
Flt Protected		1.00	1.00			1.00	0.95	1.00			1.00	1.00
Satd. Flow (prot)		0	1644			1644	1805	3275			3505	1615
Flt Permitted		1.00	1.00			1.00	0.95	1.00			1.00	1.00
Satd. Flow (perm)		0	1644			1644	1805	3275			3505	1615
Peak-hour factor, PHF	0.95	0.95	0.95	0.95	0.95	0.95	0.95	0.95	0.95	0.95	0.95	0.95
Adj. Flow (vph)	0	0	54	0	0	21	76	866	31	0	2031	5
RTOR Reduction (vph)	0	5	47	0	0	20	0	1	0	0	0	1
Lane Group Flow (vph)	0	0	2	0	0	1	76	896	0	0	2031	4
Heavy Vehicles (%)	0%	0%	0%	0%	0%	0%	0%	10%	0%	0%	3%	0%
Turn Type			Perm			Perm	Prot	NA			NA	Perm
Protected Phases	4						5	2			6	
Permitted Phases			4			8						6
Actuated Green, G (s)		0.0	4.4			4.4	8.9	96.6			83.2	83.2
Effective Green, g (s)		0.0	4.4			4.4	8.9	96.6			83.2	83.2
Actuated g/C Ratio		0.00	0.04			0.04	0.08	0.88			0.76	0.76
Clearance Time (s)			4.5			4.5	4.5	4.5			4.5	4.5
Vehicle Extension (s)			3.0			3.0	3.0	3.0			3.0	3.0
Lane Grp Cap (vph)		0	65			65	146	2876			2651	1221
v/s Ratio Prot							c0.04	0.27			c0.58	
v/s Ratio Perm			c0.00			0.00						0.00
v/c Ratio		0.00	0.03			0.01	0.52	0.31			0.77	0.00
Uniform Delay, d1		55.0	50.7			50.7	48.5	1.1			7.8	3.3
Progression Factor		1.00	1.00			1.00	0.85	0.96			0.30	1.00
Incremental Delay, d2		0.0	0.2			0.1	3.1	0.3			0.8	0.0
Delay (s)		55.0	50.9			50.8	44.4	1.3			3.1	3.3
Level of Service		D	D			D	D	A			A	A
Approach Delay (s)		51.3			50.8			4.7			3.1	
Approach LOS		D			D			A			A	
Intersection Summary												
HCM 2000 Control Delay			4.8				HCM 2000 Level of Service				A	
HCM 2000 Volume to Capacity ratio			0.71									
Actuated Cycle Length (s)			110.0				Sum of lost time (s)				13.5	
Intersection Capacity Utilization			65.0%				ICU Level of Service				C	
Analysis Period (min)			15									
c Critical Lane Group												

HCM Unsignalized Intersection Capacity Analysis

4: US 29 & Terrace Greene Circle

07/22/2021

													
Movement	EBL	EBT	EBR	WBL	WBT	WBR	NBL	NBT	NBR	SBL	SBT	SBR	
Lane Configurations													
Traffic Volume (veh/h)	0	0	3	0	0	87	0	759	15	0	2028	5	
Future Volume (Veh/h)	0	0	3	0	0	87	0	759	15	0	2028	5	
Sign Control	Stop			Stop			Free			Free			
Grade	0%			0%			0%			0%			
Peak Hour Factor	0.97	0.97	0.97	0.97	0.97	0.97	0.97	0.97	0.97	0.97	0.97	0.97	
Hourly flow rate (vph)	0	0	3	0	0	90	0	782	15	0	2091	5	
Pedestrians													
Lane Width (ft)													
Walking Speed (ft/s)													
Percent Blockage													
Right turn flare (veh)													
Median type							Raised			Raised			
Median storage (veh)							2			2			
Upstream signal (ft)													
pX, platoon unblocked													
vC, conflicting volume	2572	2888	1046	1830	2878	391	2096				797		
vC1, stage 1 conf vol	2091	2091		782	782								
vC2, stage 2 conf vol	481	797		1048	2096								
vCu, unblocked vol	2572	2888	1046	1830	2878	391	2096				797		
tC, single (s)	7.5	6.5	7.6	7.5	6.5	7.0	4.1				4.1		
tC, 2 stage (s)	6.5	5.5		6.5	5.5								
tF (s)	3.5	4.0	3.6	3.5	4.0	3.3	2.2				2.2		
p0 queue free %	100	100	98	100	100	85	100				100		
cM capacity (veh/h)	53	90	179	200	88	605	267				827		
Direction, Lane #	EB 1	WB 1	NB 1	NB 2	NB 3	SB 1	SB 2	SB 3	SB 4				
Volume Total	3	90	391	391	15	0	1046	1046	5				
Volume Left	0	0	0	0	0	0	0	0	0				
Volume Right	3	90	0	0	15	0	0	0	5				
cSH	179	605	1700	1700	1700	1700	1700	1700	1700				
Volume to Capacity	0.02	0.15	0.23	0.23	0.01	0.00	0.61	0.61	0.00				
Queue Length 95th (ft)	1	13	0	0	0	0	0	0	0				
Control Delay (s)	25.5	12.0	0.0	0.0	0.0	0.0	0.0	0.0	0.0				
Lane LOS	D	B											
Approach Delay (s)	25.5	12.0	0.0					0.0					
Approach LOS	D	B											
Intersection Summary													
Average Delay			0.4										
Intersection Capacity Utilization			66.1%	ICU Level of Service					C				
Analysis Period (min)			15										

HCM Unsignalized Intersection Capacity Analysis

5: US 29 & Keleigh Lane

07/22/2021























Movement	EBL	EBR	NBL	NBT	SBT	SBR	
Lane Configurations							
Traffic Volume (veh/h)	13	33	9	670	1872	9	
Future Volume (Veh/h)	13	33	9	670	1872	9	
Sign Control	Stop			Free	Free		
Grade	0%			0%	0%		
Peak Hour Factor	0.95	0.95	0.95	0.95	0.95	0.95	
Hourly flow rate (vph)	14	35	9	705	1971	9	
Pedestrians							
Lane Width (ft)							
Walking Speed (ft/s)							
Percent Blockage							
Right turn flare (veh)							
Median type			Raised	Raised			
Median storage (veh)			2	2			
Upstream signal (ft)							
pX, platoon unblocked							
vC, conflicting volume	2342	986	1980				
vC1, stage 1 conf vol	1971						
vC2, stage 2 conf vol	370						
vCu, unblocked vol	2342	986	1980				
tC, single (s)	6.8	7.0	4.3				
tC, 2 stage (s)	5.8						
tF (s)	3.5	3.3	2.3				
p0 queue free %	85	86	96				
cM capacity (veh/h)	94	245	256				
Direction, Lane #	EB 1	NB 1	NB 2	NB 3	SB 1	SB 2	SB 3
Volume Total	49	9	352	352	986	986	9
Volume Left	14	9	0	0	0	0	0
Volume Right	35	0	0	0	0	0	9
cSH	168	256	1700	1700	1700	1700	1700
Volume to Capacity	0.29	0.04	0.21	0.21	0.58	0.58	0.01
Queue Length 95th (ft)	29	3	0	0	0	0	0
Control Delay (s)	35.1	19.6	0.0	0.0	0.0	0.0	0.0
Lane LOS	E	C					
Approach Delay (s)	35.1	0.2	0.0				
Approach LOS	E						
Intersection Summary							
Average Delay			0.7				
Intersection Capacity Utilization			61.7%	ICU Level of Service	B		
Analysis Period (min)			15				

HCM Unsignalized Intersection Capacity Analysis

6: US 29 & Commercial Entrance

07/22/2021

												
Movement	EBL	EBT	EBR	WBL	WBT	WBR	NBL	NBT	NBR	SBL	SBT	SBR
Lane Configurations												
Traffic Volume (veh/h)	0	0	0	55	0	13	22	540	25	73	1769	0
Future Volume (Veh/h)	0	0	0	55	0	13	22	540	25	73	1769	0
Sign Control		Stop			Stop			Free			Free	
Grade		0%			0%			0%			0%	
Peak Hour Factor	0.92	0.92	0.92	0.92	0.92	0.92	0.92	0.92	0.92	0.92	0.92	0.92
Hourly flow rate (vph)	0	0	0	60	0	14	24	587	27	79	1923	0
Pedestrians												
Lane Width (ft)												
Walking Speed (ft/s)												
Percent Blockage												
Right turn flare (veh)												
Median type												
Median storage (veh)												
Upstream signal (ft)												
pX, platoon unblocked												
vC, conflicting volume	2422	2743	962	1754	2716	294	1923			614		
vC1, stage 1 conf vol	2081	2081		635	635							
vC2, stage 2 conf vol	342	662		1120	2081							
vCu, unblocked vol	2422	2743	962	1754	2716	294	1923			614		
tC, single (s)	7.5	6.5	6.9	7.5	6.5	7.1	4.1			4.2		
tC, 2 stage (s)	6.5	5.5		6.5	5.5							
tF (s)	3.5	4.0	3.3	3.5	4.0	3.4	2.2			2.2		
p0 queue free %	100	100	100	64	100	98	92			92		
cM capacity (veh/h)	50	84	260	165	62	685	311			955		
Direction, Lane #	EB 1	WB 1	NB 1	NB 2	NB 3	NB 4	SB 1	SB 2	SB 3			
Volume Total	0	74	24	294	294	27	79	962	962			
Volume Left	0	60	24	0	0	0	79	0	0			
Volume Right	0	14	0	0	0	27	0	0	0			
cSH	1700	203	311	1700	1700	1700	955	1700	1700			
Volume to Capacity	0.00	0.36	0.08	0.17	0.17	0.02	0.08	0.57	0.57			
Queue Length 95th (ft)	0	39	6	0	0	0	7	0	0			
Control Delay (s)	0.0	33.4	17.5	0.0	0.0	0.0	9.1	0.0	0.0			
Lane LOS	A	D	C				A					
Approach Delay (s)	0.0	33.4	0.7				0.4					
Approach LOS	A	D										
Intersection Summary												
Average Delay			1.3									
Intersection Capacity Utilization			65.6%		ICU Level of Service				C			
Analysis Period (min)			15									

HCM Unsignalized Intersection Capacity Analysis

7: US 29 & Lake Saponi Drive

07/22/2021



Movement	WBL	WBR	NBT	NBR	SBL	SBT
Lane Configurations		↗	↕	↗		↕
Traffic Volume (veh/h)	0	44	629	15	0	2151
Future Volume (Veh/h)	0	44	629	15	0	2151
Sign Control	Stop		Free			Free
Grade	0%		0%			0%
Peak Hour Factor	0.92	0.92	0.92	0.92	0.92	0.92
Hourly flow rate (vph)	0	48	684	16	0	2338
Pedestrians						
Lane Width (ft)						
Walking Speed (ft/s)						
Percent Blockage						
Right turn flare (veh)						
Median type			Raised			Raised
Median storage (veh)			2			2
Upstream signal (ft)						
pX, platoon unblocked						
vC, conflicting volume	1853	342			700	
vC1, stage 1 conf vol	684					
vC2, stage 2 conf vol	1169					
vCu, unblocked vol	1853	342			700	
tC, single (s)	6.8	7.1			4.1	
tC, 2 stage (s)	5.8					
tF (s)	3.5	3.4			2.2	
p0 queue free %	100	92			100	
cM capacity (veh/h)	229	637			906	
Direction, Lane #	WB 1	NB 1	NB 2	NB 3	SB 1	SB 2
Volume Total	48	342	342	16	1169	1169
Volume Left	0	0	0	0	0	0
Volume Right	48	0	0	16	0	0
cSH	637	1700	1700	1700	1700	1700
Volume to Capacity	0.08	0.20	0.20	0.01	0.69	0.69
Queue Length 95th (ft)	6	0	0	0	0	0
Control Delay (s)	11.1	0.0	0.0	0.0	0.0	0.0
Lane LOS	B					
Approach Delay (s)	11.1	0.0			0.0	
Approach LOS	B					
Intersection Summary						
Average Delay			0.2			
Intersection Capacity Utilization			62.8%	ICU Level of Service	B	
Analysis Period (min)			15			

HCM Unsignalized Intersection Capacity Analysis

8: US 29 & Greene Edge Lane

08/10/2021



Movement	EBL	EBT	EBR	WBL	WBT	WBR	NBL	NBT	NBR	SBL	SBT	SBR
Lane Configurations	↗							↖			↖	
Traffic Volume (veh/h)	0	0	1	0	0	0	1	726	0	8	2236	0
Future Volume (Veh/h)	0	0	1	0	0	0	1	726	0	8	2236	0
Sign Control		Stop			Stop			Free			Free	
Grade		0%			0%			0%			0%	
Peak Hour Factor	0.92	0.92	0.92	0.92	0.92	0.92	0.92	0.92	0.92	0.92	0.92	0.92
Hourly flow rate (vph)	0	0	1	0	0	0	1	789	0	9	2430	0
Pedestrians												
Lane Width (ft)												
Walking Speed (ft/s)												
Percent Blockage												
Right turn flare (veh)												
Median type												
Median storage (veh)												
Upstream signal (ft)												
pX, platoon unblocked												
vC, conflicting volume	2844	3239	1215	2025	3239	394	2430			789		
vC1, stage 1 conf vol	2448	2448		791	791							
vC2, stage 2 conf vol	396	791		1234	2448							
vCu, unblocked vol	2844	3239	1215	2025	3239	394	2430			789		
tC, single (s)	7.5	6.5	6.9	7.5	6.5	6.9	4.1			4.1		
tC, 2 stage (s)	6.5	5.5		6.5	5.5							
tF (s)	3.5	4.0	3.3	3.5	4.0	3.3	2.2			2.2		
p0 queue free %	100	100	99	100	100	100	99			99		
cM capacity (veh/h)	31	58	176	159	57	605	197			827		
Direction, Lane #												
	EB 1	NB 1	NB 2	SB 1	SB 2							
Volume Total	1	264	526	1224	1215							
Volume Left	0	1	0	9	0							
Volume Right	1	0	0	0	0							
cSH	176	197	1700	827	1700							
Volume to Capacity	0.01	0.01	0.31	0.01	0.71							
Queue Length 95th (ft)	0	0	0	1	0							
Control Delay (s)	25.5	0.2	0.0	0.4	0.0							
Lane LOS	D	A		A								
Approach Delay (s)	25.5	0.1		0.2								
Approach LOS	D											
Intersection Summary												
Average Delay			0.2									
Intersection Capacity Utilization			Err%	ICU Level of Service	H							
Analysis Period (min)			15									

Queues

9: US 29 & Frays Mill Road

07/22/2021



Lane Group	EBT	WBT	NBL	NBT	NBR	SBL	SBT	SBR
Lane Group Flow (vph)	274	230	12	732	32	47	2493	17
v/c Ratio	0.77	2.95	0.09	0.69	0.06	0.38	1.77	0.02
Control Delay	23.6	927.5	42.2	44.2	2.0	52.5	374.2	0.1
Queue Delay	0.0	0.0	0.0	0.0	0.0	0.0	0.0	0.0
Total Delay	23.6	927.5	42.2	44.2	2.0	52.5	374.2	0.1
Queue Length 50th (ft)	17	~231	7	277	0	31	~1389	0
Queue Length 95th (ft)	#135	#390	27	341	8	m53	#1707	m0
Internal Link Dist (ft)	875	1084		5794			2491	
Turn Bay Length (ft)			350		350	375		375
Base Capacity (vph)	358	78	131	1058	553	123	1408	738
Starvation Cap Reductn	0	0	0	0	0	0	0	0
Spillback Cap Reductn	0	0	0	0	0	0	0	0
Storage Cap Reductn	0	0	0	0	0	0	0	0
Reduced v/c Ratio	0.77	2.95	0.09	0.69	0.06	0.38	1.77	0.02

Intersection Summary

- ~ Volume exceeds capacity, queue is theoretically infinite.
Queue shown is maximum after two cycles.
- # 95th percentile volume exceeds capacity, queue may be longer.
Queue shown is maximum after two cycles.
- m Volume for 95th percentile queue is metered by upstream signal.

HCM Signalized Intersection Capacity Analysis

9: US 29 & Frays Mill Road

07/22/2021





















Movement	EBL	EBT	EBR	WBL	WBT	WBR	NBL	NBT	NBR	SBL	SBT	SBR
Lane Configurations		↔			↔		↗	↕	↗	↗	↕	↗
Traffic Volume (vph)	15	9	228	154	9	49	11	673	29	43	2294	16
Future Volume (vph)	15	9	228	154	9	49	11	673	29	43	2294	16
Ideal Flow (vphpl)	1900	1900	1900	1900	1900	1900	1900	1900	1900	1900	1900	1900
Total Lost time (s)		6.0			6.0		6.0	6.0	6.0	6.0	6.0	6.0
Lane Util. Factor		1.00			1.00		1.00	0.95	1.00	1.00	0.95	1.00
Frt		0.88			0.97		1.00	1.00	0.85	1.00	1.00	0.85
Flt Protected		1.00			0.96		0.95	1.00	1.00	0.95	1.00	1.00
Satd. Flow (prot)		1525			1756		1805	3252	1392	1703	3505	1615
Flt Permitted		0.96			0.12		0.95	1.00	1.00	0.95	1.00	1.00
Satd. Flow (perm)		1465			217		1805	3252	1392	1703	3505	1615
Peak-hour factor, PHF	0.92	0.92	0.92	0.92	0.92	0.92	0.92	0.92	0.92	0.92	0.92	0.92
Adj. Flow (vph)	16	10	248	167	10	53	12	732	32	47	2493	17
RTOR Reduction (vph)	0	225	0	0	10	0	0	0	22	0	0	11
Lane Group Flow (vph)	0	49	0	0	220	0	12	732	10	47	2493	6
Heavy Vehicles (%)	0%	0%	10%	0%	0%	5%	0%	11%	16%	6%	3%	0%
Turn Type	Perm	NA		Perm	NA		Prot	NA	Prot	Prot	NA	Prot
Protected Phases		4			3		5	2	2	1	6	6
Permitted Phases	4			3								
Actuated Green, G (s)		10.0			35.0		1.6	34.6	34.6	6.4	39.4	39.4
Effective Green, g (s)		10.0			35.0		1.6	34.6	34.6	6.4	39.4	39.4
Actuated g/C Ratio		0.09			0.32		0.01	0.31	0.31	0.06	0.36	0.36
Clearance Time (s)		6.0			6.0		6.0	6.0	6.0	6.0	6.0	6.0
Vehicle Extension (s)		4.0			4.0		3.5	6.0	6.0	3.5	6.0	6.0
Lane Grp Cap (vph)		133			69		26	1022	437	99	1255	578
v/s Ratio Prot							0.01	0.23	0.01	c0.03	c0.71	0.00
v/s Ratio Perm		c0.03			c1.01							
v/c Ratio		0.37			3.19		0.46	0.72	0.02	0.47	1.99	0.01
Uniform Delay, d1		47.0			37.5		53.8	33.4	26.0	50.2	35.3	22.7
Progression Factor		1.00			1.00		0.85	1.21	1.00	0.90	0.96	1.00
Incremental Delay, d2		2.3			1024.4		14.4	4.3	0.1	3.8	446.5	0.0
Delay (s)		49.3			1061.9		60.2	44.5	26.1	49.1	480.4	22.8
Level of Service		D			F		E	D	C	D	F	C
Approach Delay (s)		49.3			1061.9			44.0			469.4	
Approach LOS		D			F			D			F	

Intersection Summary

HCM 2000 Control Delay	388.9	HCM 2000 Level of Service	F
HCM 2000 Volume to Capacity ratio	2.28		
Actuated Cycle Length (s)	110.0	Sum of lost time (s)	24.0
Intersection Capacity Utilization	105.8%	ICU Level of Service	G
Analysis Period (min)	15		
c Critical Lane Group			

HCM Unsignalized Intersection Capacity Analysis
 10: US 29 & Dickerson Road

07/22/2021

												
Movement	EBL	EBT	EBR	WBL	WBT	WBR	NBL	NBT	NBR	SBL	SBT	SBR
Lane Configurations												
Traffic Volume (veh/h)	12	0	17	1	0	0	13	700	0	2	2474	19
Future Volume (Veh/h)	12	0	17	1	0	0	13	700	0	2	2474	19
Sign Control		Stop			Stop			Free			Free	
Grade		0%			0%			0%			0%	
Peak Hour Factor	0.96	0.96	0.96	0.96	0.96	0.96	0.96	0.96	0.96	0.96	0.96	0.96
Hourly flow rate (vph)	13	0	18	1	0	0	14	729	0	2	2577	20
Pedestrians												
Lane Width (ft)												
Walking Speed (ft/s)												
Percent Blockage												
Right turn flare (veh)												
Median type												
Median storage (veh)												
Upstream signal (ft)												
pX, platoon unblocked												
vC, conflicting volume	2974	3338	1288	2068	3358	364	2597			729		
vC1, stage 1 conf vol	2581	2581		757	757							
vC2, stage 2 conf vol	392	757		1310	2601							
vCu, unblocked vol	2974	3338	1288	2068	3358	364	2597			729		
tC, single (s)	7.5	6.5	7.0	7.5	6.5	6.9	4.6			4.1		
tC, 2 stage (s)	6.5	5.5		6.5	5.5							
tF (s)	3.5	4.0	3.4	3.5	4.0	3.3	2.5			2.2		
p0 queue free %	50	100	88	99	100	100	87			100		
cM capacity (veh/h)	26	51	148	123	37	638	110			884		
Direction, Lane #	EB 1	WB 1	NB 1	NB 2	NB 3	SB 1	SB 2	SB 3	SB 4			
Volume Total	31	1	14	486	243	2	1288	1288	20			
Volume Left	13	1	14	0	0	2	0	0	0			
Volume Right	18	0	0	0	0	0	0	0	20			
cSH	50	123	110	1700	1700	884	1700	1700	1700			
Volume to Capacity	0.62	0.01	0.13	0.29	0.14	0.00	0.76	0.76	0.01			
Queue Length 95th (ft)	61	1	11	0	0	0	0	0	0			
Control Delay (s)	158.8	34.6	42.5	0.0	0.0	9.1	0.0	0.0	0.0			
Lane LOS	F	D	E			A						
Approach Delay (s)	158.8	34.6	0.8			0.0						
Approach LOS	F	D										
Intersection Summary												
Average Delay			1.7									
Intersection Capacity Utilization			78.4%		ICU Level of Service				D			
Analysis Period (min)			15									

Queues

11: US 29 & Austin Drive

07/22/2021



Lane Group	EBL	EBT	NBL	NBT	SBT	SBR
Lane Group Flow (vph)	2	35	18	661	2504	11
v/c Ratio	0.02	0.27	0.17	0.23	0.87	0.01
Control Delay	47.5	22.7	40.0	2.1	23.1	0.0
Queue Delay	0.0	0.0	0.0	0.0	0.0	0.0
Total Delay	47.5	22.7	40.0	2.1	23.1	0.0
Queue Length 50th (ft)	1	1	12	45	972	0
Queue Length 95th (ft)	9	34	36	65	m566	m0
Internal Link Dist (ft)		306		2056	2636	
Turn Bay Length (ft)			500			350
Base Capacity (vph)	120	130	108	2860	2883	1159
Starvation Cap Reductn	0	0	0	0	0	0
Spillback Cap Reductn	0	0	0	0	0	0
Storage Cap Reductn	0	0	0	0	0	0
Reduced v/c Ratio	0.02	0.27	0.17	0.23	0.87	0.01



















Intersection Summary

m Volume for 95th percentile queue is metered by upstream signal.

HCM Signalized Intersection Capacity Analysis

11: US 29 & Austin Drive

07/22/2021

												
Movement	EBL	EBT	EBR	WBL	WBT	WBR	NBL	NBT	NBR	SBL	SBT	SBR
Lane Configurations												
Traffic Volume (vph)	2	2	31	0	0	0	17	628	0	0	2379	10
Future Volume (vph)	2	2	31	0	0	0	17	628	0	0	2379	10
Ideal Flow (vphpl)	1900	1900	1900	1900	1900	1900	1900	1900	1900	1900	1900	1900
Total Lost time (s)	7.5	7.5					7.5	7.0			7.0	7.0
Lane Util. Factor	1.00	1.00					1.00	0.95			0.95	1.00
Frt	1.00	0.86					1.00	1.00			1.00	0.85
Flt Protected	0.95	1.00					0.95	1.00			1.00	1.00
Satd. Flow (prot)	1805	1491					1612	3252			3505	1369
Flt Permitted	0.95	1.00					0.95	1.00			1.00	1.00
Satd. Flow (perm)	1805	1491					1612	3252			3505	1369
Peak-hour factor, PHF	0.95	0.95	0.95	0.95	0.95	0.95	0.95	0.95	0.95	0.95	0.95	0.95
Adj. Flow (vph)	2	2	33	0	0	0	18	661	0	0	2504	11
RTOR Reduction (vph)	0	32	0	0	0	0	0	0	0	0	0	3
Lane Group Flow (vph)	2	3	0	0	0	0	18	661	0	0	2504	8
Heavy Vehicles (%)	0%	0%	10%	0%	0%	0%	12%	11%	0%	0%	3%	18%
Turn Type	Split	NA					Prot	NA			NA	Prot
Protected Phases	4	4			3		5	2			6	6
Permitted Phases				3						6		
Actuated Green, G (s)	4.6	4.6					3.2	90.9			80.2	80.2
Effective Green, g (s)	4.6	4.6					3.2	90.9			80.2	80.2
Actuated g/C Ratio	0.04	0.04					0.03	0.83			0.73	0.73
Clearance Time (s)	7.5	7.5					7.5	7.0			7.0	7.0
Vehicle Extension (s)	3.0	3.0					3.0	3.0			3.0	3.0
Lane Grp Cap (vph)	75	62					46	2687			2555	998
v/s Ratio Prot	0.00	c0.00					0.01	c0.20			c0.71	0.01
v/s Ratio Perm												
v/c Ratio	0.03	0.05					0.39	0.25			0.98	0.01
Uniform Delay, d1	50.6	50.6					52.4	2.1			14.1	4.1
Progression Factor	1.00	1.00					0.76	0.95			2.16	1.00
Incremental Delay, d2	0.1	0.4					5.2	0.2			2.4	0.0
Delay (s)	50.7	51.0					45.2	2.2			33.0	4.1
Level of Service	D	D					D	A			C	A
Approach Delay (s)		51.0			0.0			3.3			32.9	
Approach LOS		D			A			A			C	
Intersection Summary												
HCM 2000 Control Delay			26.9				HCM 2000 Level of Service				C	
HCM 2000 Volume to Capacity ratio			1.00									
Actuated Cycle Length (s)			110.0				Sum of lost time (s)			29.0		
Intersection Capacity Utilization			83.7%				ICU Level of Service			E		
Analysis Period (min)			15									
c	Critical Lane Group											

Queues

12: US 29 & Boulders Road

07/22/2021

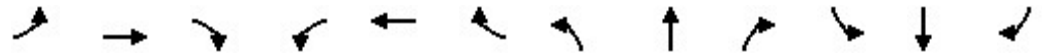

Lane Group	EBL	EBT	EBR	WBL	WBT	WBR	NBL	NBT	NBR	SBL	SBT	SBR
Lane Group Flow (vph)	15	32	129	10	11	15	48	645	212	128	2376	66
v/c Ratio	0.15	0.15	0.52	0.09	0.10	0.06	0.43	0.33	0.20	0.50	1.05	0.06
Control Delay	52.4	50.5	12.1	50.6	50.8	0.4	62.0	12.0	2.1	65.3	45.1	0.1
Queue Delay	0.0	0.0	0.0	0.0	0.0	0.0	0.0	0.0	0.0	0.0	0.0	0.0
Total Delay	52.4	50.5	12.1	50.6	50.8	0.4	62.0	12.0	2.1	65.3	45.1	0.1
Queue Length 50th (ft)	10	12	0	7	7	0	33	125	0	44	~1064	0
Queue Length 95th (ft)	35	29	37	26	27	0	73	165	32	m59	#1193	m0
Internal Link Dist (ft)		179			369			1679			2056	
Turn Bay Length (ft)			175			350	400		300	550		425
Base Capacity (vph)	99	213	247	109	109	251	111	1966	1067	264	2253	1106
Starvation Cap Reductn	0	0	0	0	0	0	0	0	0	0	0	0
Spillback Cap Reductn	0	0	0	0	0	0	0	0	0	0	0	0
Storage Cap Reductn	0	0	0	0	0	0	0	0	0	0	0	0
Reduced v/c Ratio	0.15	0.15	0.52	0.09	0.10	0.06	0.43	0.33	0.20	0.48	1.05	0.06





























Intersection Summary

- ~ Volume exceeds capacity, queue is theoretically infinite.
Queue shown is maximum after two cycles.
- # 95th percentile volume exceeds capacity, queue may be longer.
Queue shown is maximum after two cycles.
- m Volume for 95th percentile queue is metered by upstream signal.

HCM Signalized Intersection Capacity Analysis





















12: US 29 & Boulders Road

07/22/2021

													
Movement	EBL	EBT	EBR	WBL	WBT	WBR	NBL	NBT	NBR	SBL	SBT	SBR	
Lane Configurations		 						 		 	 		
Traffic Volume (vph)	23	22	121	19	1	14	45	606	199	120	2233	62	
Future Volume (vph)	23	22	121	19	1	14	45	606	199	120	2233	62	
Ideal Flow (vphpl)	1900	1900	1900	1900	1900	1900	1900	1900	1900	1900	1900	1900	
Total Lost time (s)	6.9	6.9	6.9	6.9	6.9	6.9	5.9	6.2	6.2	6.4	6.0	6.0	
Lane Util. Factor	0.91	0.91	1.00	0.95	0.95	1.00	1.00	0.95	1.00	0.97	0.95	1.00	
Frt	1.00	1.00	0.85	1.00	1.00	0.85	1.00	1.00	0.85	1.00	1.00	0.85	
Flt Protected	0.95	0.99	1.00	0.95	0.96	1.00	0.95	1.00	1.00	0.95	1.00	1.00	
Satd. Flow (prot)	1564	3363	1553	1715	1727	1615	1752	3223	1615	3502	3471	1615	
Flt Permitted	0.95	0.99	1.00	0.95	0.96	1.00	0.95	1.00	1.00	0.95	1.00	1.00	
Satd. Flow (perm)	1564	3363	1553	1715	1727	1615	1752	3223	1615	3502	3471	1615	
Peak-hour factor, PHF	0.94	0.94	0.94	0.94	0.94	0.94	0.94	0.94	0.94	0.94	0.94	0.94	
Adj. Flow (vph)	24	23	129	20	1	15	48	645	212	128	2376	66	
RTOR Reduction (vph)	0	0	121	0	0	14	0	0	88	0	0	26	
Lane Group Flow (vph)	15	32	8	10	11	1	48	645	124	128	2376	41	
Heavy Vehicles (%)	5%	0%	4%	0%	0%	0%	3%	12%	0%	0%	4%	0%	
Turn Type	Split	NA	Prot	Split	NA	Prot	Prot	NA	Prot	Prot	NA	Prot	
Protected Phases	4	4	4	3	3	3	5	2	2	1	6	6	
Permitted Phases													
Actuated Green, G (s)	7.0	7.0	7.0	4.2	4.2	4.2	5.6	64.4	64.4	8.0	67.5	67.5	
Effective Green, g (s)	7.0	7.0	7.0	4.2	4.2	4.2	5.6	64.4	64.4	8.0	67.5	67.5	
Actuated g/C Ratio	0.06	0.06	0.06	0.04	0.04	0.04	0.05	0.59	0.59	0.07	0.61	0.61	
Clearance Time (s)	6.9	6.9	6.9	6.9	6.9	6.9	5.9	6.2	6.2	6.4	6.0	6.0	
Vehicle Extension (s)	3.0	3.0	3.0	3.0	3.0	3.0	3.0	3.0	3.0	3.0	3.0	3.0	
Lane Grp Cap (vph)	99	214	98	65	65	61	89	1886	945	254	2129	991	
v/s Ratio Prot	c0.01	0.01	0.01	0.01	c0.01	0.00	0.03	0.20	0.08	c0.04	c0.68	0.03	
v/s Ratio Perm													
v/c Ratio	0.15	0.15	0.08	0.15	0.17	0.01	0.54	0.34	0.13	0.50	1.12	0.04	
Uniform Delay, d1	48.7	48.7	48.5	51.2	51.2	50.9	50.9	11.8	10.2	49.1	21.2	8.4	
Progression Factor	1.00	1.00	1.00	1.00	1.00	1.00	1.00	1.00	1.00	1.26	0.46	1.00	
Incremental Delay, d2	0.7	0.3	0.4	1.1	1.2	0.1	6.2	0.5	0.3	0.8	56.0	0.0	
Delay (s)	49.4	49.0	48.9	52.3	52.4	51.0	57.1	12.3	10.5	62.4	65.8	8.5	
Level of Service	D	D	D	D	D	D	E	B	B	E	E	A	
Approach Delay (s)		48.9			51.8			14.3			64.2		
Approach LOS		D			D			B			E		
Intersection Summary													
HCM 2000 Control Delay			51.1									HCM 2000 Level of Service	D
HCM 2000 Volume to Capacity ratio			0.97										
Actuated Cycle Length (s)			110.0									Sum of lost time (s)	26.4
Intersection Capacity Utilization			91.6%									ICU Level of Service	F
Analysis Period (min)			15										
c Critical Lane Group													

HCM Unsignalized Intersection Capacity Analysis
 13: US 29 & Camelot Drive

07/22/2021

												
Movement	EBL	EBT	EBR	WBL	WBT	WBR	NBL	NBT	NBR	SBL	SBT	SBR
Lane Configurations												
Traffic Volume (veh/h)	7	0	48	6	0	2	27	992	8	3	2468	6
Future Volume (Veh/h)	7	0	48	6	0	2	27	992	8	3	2468	6
Sign Control		Stop			Stop			Free			Free	
Grade		0%			0%			0%			0%	
Peak Hour Factor	0.95	0.95	0.95	0.95	0.95	0.95	0.95	0.95	0.95	0.95	0.95	0.95
Hourly flow rate (vph)	7	0	51	6	0	2	28	1044	8	3	2598	6
Pedestrians												
Lane Width (ft)												
Walking Speed (ft/s)												
Percent Blockage												
Right turn flare (veh)												
Median type												
Median storage (veh)												
Upstream signal (ft)												
pX, platoon unblocked												
vC, conflicting volume	3184	3712	1299	2456	3710	522	2604			1052		
vC1, stage 1 conf vol	2604	2604		1100	1100							
vC2, stage 2 conf vol	580	1108		1356	2610							
vCu, unblocked vol	3184	3712	1299	2456	3710	522	2604			1052		
tC, single (s)	7.8	6.5	7.0	7.5	6.5	6.9	4.2			4.1		
tC, 2 stage (s)	6.8	5.5		6.5	5.5							
tF (s)	3.6	4.0	3.4	3.5	4.0	3.3	2.2			2.2		
p0 queue free %	65	100	65	91	100	100	82			100		
cM capacity (veh/h)	20	49	146	68	22	505	155			669		
Direction, Lane #	EB 1	WB 1	NB 1	NB 2	NB 3	NB 4	SB 1	SB 2	SB 3	SB 4		
Volume Total	58	8	28	522	522	8	3	1299	1299	6		
Volume Left	7	6	28	0	0	0	3	0	0	0		
Volume Right	51	2	0	0	0	8	0	0	0	6		
cSH	83	87	155	1700	1700	1700	669	1700	1700	1700		
Volume to Capacity	0.70	0.09	0.18	0.31	0.31	0.00	0.00	0.76	0.76	0.00		
Queue Length 95th (ft)	84	7	16	0	0	0	0	0	0	0		
Control Delay (s)	115.1	50.8	33.2	0.0	0.0	0.0	10.4	0.0	0.0	0.0		
Lane LOS	F	F	D				B					
Approach Delay (s)	115.1	50.8	0.9				0.0					
Approach LOS	F	F										
Intersection Summary												
Average Delay			2.1									
Intersection Capacity Utilization			78.2%		ICU Level of Service					D		
Analysis Period (min)			15									

HCM Unsignalized Intersection Capacity Analysis
 18: US 29 & Airport Acres Rd South

07/22/2021



Movement	EBL	EBR	NBL	NBT	SBT	SBR
Lane Configurations	↘		↘	↑↑	↑↑	
Traffic Volume (veh/h)	2	6	19	1096	2564	1
Future Volume (Veh/h)	2	6	19	1096	2564	1
Sign Control	Stop			Free	Free	
Grade	0%			0%	0%	
Peak Hour Factor	0.93	0.93	0.93	0.93	0.93	0.93
Hourly flow rate (vph)	2	6	20	1178	2757	1
Pedestrians						
Lane Width (ft)						
Walking Speed (ft/s)						
Percent Blockage						
Right turn flare (veh)						
Median type				Raised	Raised	
Median storage (veh)				2	2	
Upstream signal (ft)				872		
pX, platoon unblocked	0.76					
vC, conflicting volume	3386	1379	2758			
vC1, stage 1 conf vol	2758					
vC2, stage 2 conf vol	629					
vCu, unblocked vol	3506	1379	2758			
tC, single (s)	6.8	7.3	4.1			
tC, 2 stage (s)	5.8					
tF (s)	3.5	3.5	2.2			
p0 queue free %	94	95	86			
cM capacity (veh/h)	34	114	146			
Direction, Lane #	EB 1	NB 1	NB 2	NB 3	SB 1	SB 2
Volume Total	8	20	589	589	1838	920
Volume Left	2	20	0	0	0	0
Volume Right	6	0	0	0	0	1
cSH	72	146	1700	1700	1700	1700
Volume to Capacity	0.11	0.14	0.35	0.35	1.08	0.54
Queue Length 95th (ft)	9	12	0	0	0	0
Control Delay (s)	61.4	33.4	0.0	0.0	0.0	0.0
Lane LOS	F	D				
Approach Delay (s)	61.4	0.6	0.0			
Approach LOS	F					
Intersection Summary						
Average Delay			0.3			
Intersection Capacity Utilization			80.9%	ICU Level of Service	D	
Analysis Period (min)			15			

Queues

19: US 29 & Airport Road

07/22/2021



Lane Group	EBL	EBT	EBR	WBL	WBT	NBL	NBT	NBR	SBL	SBT	SBR
Lane Group Flow (vph)	118	78	102	138	235	216	1051	149	254	2205	122
v/c Ratio	0.79	0.84	0.16	1.14	1.30	1.08	0.69	0.15	0.85	1.13	0.11
Control Delay	88.8	111.6	0.6	172.6	200.1	137.4	28.4	0.9	71.9	90.5	1.3
Queue Delay	0.0	0.0	0.0	0.0	0.0	0.0	0.0	0.0	0.0	0.0	0.0
Total Delay	88.8	111.6	0.6	172.6	200.1	137.4	28.4	0.9	71.9	90.5	1.3
Queue Length 50th (ft)	45	58	0	~119	~178	~92	326	0	181	~996	0
Queue Length 95th (ft)	#96	#149	0	#247	#339	#171	406	13	#309	#1132	17
Internal Link Dist (ft)		677			627		911			792	
Turn Bay Length (ft)	425		450	570		575		430	475		540
Base Capacity (vph)	149	93	624	121	181	200	1523	990	321	1955	1080
Starvation Cap Reductn	0	0	0	0	0	0	0	0	0	0	0
Spillback Cap Reductn	0	0	0	0	0	0	0	0	0	0	0
Storage Cap Reductn	0	0	0	0	0	0	0	0	0	0	0
Reduced v/c Ratio	0.79	0.84	0.16	1.14	1.30	1.08	0.69	0.15	0.79	1.13	0.11

Intersection Summary

~ Volume exceeds capacity, queue is theoretically infinite.































Queue shown is maximum after two cycles.

95th percentile volume exceeds capacity, queue may be longer.

Queue shown is maximum after two cycles.

HCM Signalized Intersection Capacity Analysis
19: US 29 & Airport Road

07/22/2021

												
Movement	EBL	EBT	EBR	WBL	WBT	WBR	NBL	NBT	NBR	SBL	SBT	SBR
Lane Configurations	 		  				 	 		 	 	
Traffic Volume (vph)	111	73	96	130	77	144	203	988	140	239	2073	115
Future Volume (vph)	111	73	96	130	77	144	203	988	140	239	2073	115
Ideal Flow (vphpl)	1900	1900	1900	1900	1900	1900	1900	1900	1900	1900	1900	1900
Total Lost time (s)	10.5	6.7	6.7	9.1	5.6		8.3	5.7	5.7	8.1	5.7	5.7
Lane Util. Factor	0.97	1.00	0.88	1.00	1.00		0.97	0.95	1.00	1.00	0.95	1.00
Frt	1.00	1.00	0.85	1.00	0.90		1.00	1.00	0.85	1.00	1.00	0.85
Flt Protected	0.95	1.00	1.00	0.95	1.00		0.95	1.00	1.00	0.95	1.00	1.00
Satd. Flow (prot)	3433	1845	2538	1770	1682		3433	3374	1524	1736	3471	1495
Flt Permitted	0.95	1.00	1.00	0.95	1.00		0.95	1.00	1.00	0.95	1.00	1.00
Satd. Flow (perm)	3433	1845	2538	1770	1682		3433	3374	1524	1736	3471	1495
Peak-hour factor, PHF	0.94	0.94	0.94	0.94	0.94	0.94	0.94	0.94	0.94	0.94	0.94	0.94
Adj. Flow (vph)	118	78	102	138	82	153	216	1051	149	254	2205	122
RTOR Reduction (vph)	0	0	85	0	58	0	0	0	64	0	0	41
Lane Group Flow (vph)	118	78	17	138	177	0	216	1051	85	254	2205	81
Heavy Vehicles (%)	2%	3%	12%	2%	0%	3%	2%	7%	6%	4%	4%	8%
Turn Type	Prot	NA	pt+ov	Prot	NA		Prot	NA	pt+ov	Prot	NA	pt+ov
Protected Phases	7	4	4 5	3	8		5	2	2 3	1	6	6 7
Permitted Phases												
Actuated Green, G (s)	5.0	5.8	19.2	7.9	8.4		6.7	51.9	65.5	19.8	64.8	75.5
Effective Green, g (s)	5.0	5.8	19.2	7.9	8.4		6.7	51.9	65.5	19.8	64.8	75.5
Actuated g/C Ratio	0.04	0.05	0.17	0.07	0.07		0.06	0.45	0.57	0.17	0.56	0.66
Clearance Time (s)	10.5	6.7		9.1	5.6		8.3	5.7		8.1	5.7	
Vehicle Extension (s)	3.0	3.0		3.0	3.0		3.0	3.0		3.0	3.0	
Lane Grp Cap (vph)	149	93	423	121	122		200	1522	868	298	1955	981
v/s Ratio Prot	0.03	0.04	0.01	c0.08	c0.11		0.06	0.31	0.06	c0.15	c0.64	0.05
v/s Ratio Perm												
v/c Ratio	0.79	0.84	0.04	1.14	1.45		1.08	0.69	0.10	0.85	1.13	0.08
Uniform Delay, d1	54.5	54.1	40.2	53.5	53.3		54.1	25.1	11.3	46.2	25.1	7.2
Progression Factor	1.00	1.00	1.00	1.00	1.00		1.00	1.00	1.00	1.00	1.00	1.00
Incremental Delay, d2	24.3	45.2	0.0	124.5	241.2		86.5	2.6	0.0	20.3	64.8	0.0
Delay (s)	78.8	99.3	40.2	178.1	294.5		140.7	27.7	11.3	66.5	89.9	7.2
Level of Service	E	F	D	F	F		F	C	B	E	F	A
Approach Delay (s)		71.0			251.5			43.2			83.7	
Approach LOS		E			F			D			F	
Intersection Summary												
HCM 2000 Control Delay			84.0			HCM 2000 Level of Service				F		
HCM 2000 Volume to Capacity ratio			1.23									
Actuated Cycle Length (s)			115.0			Sum of lost time (s)			30.1			
Intersection Capacity Utilization			102.1%			ICU Level of Service			G			
Analysis Period (min)			15									
c Critical Lane Group												

Queues

141: US 29 (S) & Lewis and Clark U-Turn N

07/22/2021



Lane Group	WBL	SBT
Lane Group Flow (vph)	65	2839
v/c Ratio	0.43	0.95
Control Delay	52.5	17.3
Queue Delay	0.0	0.0
Total Delay	52.5	17.3
Queue Length 50th (ft)	42	686
Queue Length 95th (ft)	89	#1247
Internal Link Dist (ft)	23	492
Turn Bay Length (ft)		
Base Capacity (vph)	300	2995
Starvation Cap Reductn	0	0
Spillback Cap Reductn	0	0
Storage Cap Reductn	0	0
Reduced v/c Ratio	0.22	0.95

Intersection Summary

95th percentile volume exceeds capacity, queue may be longer.
 Queue shown is maximum after two cycles.

HCM Signalized Intersection Capacity Analysis
 141: US 29 (S) & Lewis and Clark U-Turn N

07/22/2021



Movement	WBL	WBR	NBT	NBR	SBL	SBT
Lane Configurations	↶					↷↷
Traffic Volume (vph)	60	0	0	0	0	2612
Future Volume (vph)	60	0	0	0	0	2612
Ideal Flow (vphpl)	1900	1900	1900	1900	1900	1900
Total Lost time (s)	4.5					4.5
Lane Util. Factor	1.00					0.95
Frt	1.00					1.00
Flt Protected	0.95					1.00
Satd. Flow (prot)	1805					3471
Flt Permitted	0.95					1.00
Satd. Flow (perm)	1805					3471
Peak-hour factor, PHF	0.92	0.92	0.92	0.92	0.92	0.92
Adj. Flow (vph)	65	0	0	0	0	2839
RTOR Reduction (vph)	6	0	0	0	0	0
Lane Group Flow (vph)	59	0	0	0	0	2839
Heavy Vehicles (%)	0%	0%	2%	2%	0%	4%
Turn Type	Prot					NA
Protected Phases	8					6
Permitted Phases						
Actuated Green, G (s)	7.9					93.1
Effective Green, g (s)	7.9					93.1
Actuated g/C Ratio	0.07					0.85
Clearance Time (s)	4.5					4.5
Vehicle Extension (s)	3.0					3.0
Lane Grp Cap (vph)	129					2937
v/s Ratio Prot	c0.03					c0.82
v/s Ratio Perm						
v/c Ratio	0.46					0.97
Uniform Delay, d1	49.0					7.1
Progression Factor	1.04					1.00
Incremental Delay, d2	2.4					10.5
Delay (s)	53.4					17.6
Level of Service	D					B
Approach Delay (s)	53.4		0.0			17.6
Approach LOS	D		A			B
Intersection Summary						
HCM 2000 Control Delay			18.4		HCM 2000 Level of Service	B
HCM 2000 Volume to Capacity ratio			0.93			
Actuated Cycle Length (s)			110.0		Sum of lost time (s)	9.0
Intersection Capacity Utilization			110.4%		ICU Level of Service	H
Analysis Period (min)			15			
c Critical Lane Group						

HCM Unsignalized Intersection Capacity Analysis
 142: US 29 (N) & Lewis and Clark U-Turn N

07/22/2021



Movement	EBL	EBR	NBL	NBT	SBT	SBR
Lane Configurations						
Traffic Volume (veh/h)	0	0	60	1125	0	0
Future Volume (Veh/h)	0	0	60	1125	0	0
Sign Control	Stop			Free	Free	
Grade	0%			0%	0%	
Peak Hour Factor	0.92	0.92	0.92	0.92	0.92	0.92
Hourly flow rate (vph)	0	0	65	1223	0	0
Pedestrians						
Lane Width (ft)						
Walking Speed (ft/s)						
Percent Blockage						
Right turn flare (veh)						
Median type				None	None	
Median storage (veh)						
Upstream signal (ft)	861					
pX, platoon unblocked	0.93					
vC, conflicting volume	742	0	0			
vC1, stage 1 conf vol						
vC2, stage 2 conf vol						
vCu, unblocked vol	579	0	0			
tC, single (s)	6.8	6.9	4.1			
tC, 2 stage (s)						
tF (s)	3.5	3.3	2.2			
p0 queue free %	100	100	96			
cM capacity (veh/h)	399	1084	1636			
Direction, Lane #	NB 1	NB 2	NB 3			
Volume Total	65	612	612			
Volume Left	65	0	0			
Volume Right	0	0	0			
cSH	1636	1700	1700			
Volume to Capacity	0.04	0.36	0.36			
Queue Length 95th (ft)	3	0	0			
Control Delay (s)	7.3	0.0	0.0			
Lane LOS	A					
Approach Delay (s)	0.4					
Approach LOS						
Intersection Summary						
Average Delay			0.4			
Intersection Capacity Utilization			110.4%	ICU Level of Service	H	
Analysis Period (min)			15			

HCM Unsignalized Intersection Capacity Analysis
 143: US 29 (S)

07/22/2021



Movement	WBL	WBR	NBT	NBR	SBL	SBT
Lane Configurations					↘	↕↕
Traffic Volume (veh/h)	0	0	0	0	10	2671
Future Volume (Veh/h)	0	0	0	0	10	2671
Sign Control	Stop		Free			Free
Grade	0%		0%			0%
Peak Hour Factor	0.92	0.92	0.92	0.92	0.95	0.95
Hourly flow rate (vph)	0	0	0	0	11	2812
Pedestrians						
Lane Width (ft)						
Walking Speed (ft/s)						
Percent Blockage						
Right turn flare (veh)						
Median type	None			None		
Median storage (veh)						
Upstream signal (ft)	295			850		
pX, platoon unblocked	0.17					
vC, conflicting volume	1428	0	0			
vC1, stage 1 conf vol						
vC2, stage 2 conf vol						
vCu, unblocked vol	0	0	0			
tC, single (s)	6.8	6.9	4.1			
tC, 2 stage (s)						
tF (s)	3.5	3.3	2.2			
p0 queue free %	100	100	99			
cM capacity (veh/h)	173	1084	1636			
Direction, Lane #	SB 1	SB 2	SB 3			
Volume Total	11	1406	1406			
Volume Left	11	0	0			
Volume Right	0	0	0			
cSH	1636	1700	1700			
Volume to Capacity	0.01	0.83	0.83			
Queue Length 95th (ft)	1	0	0			
Control Delay (s)	7.2	0.0	0.0			
Lane LOS	A					
Approach Delay (s)	0.0					
Approach LOS						
Intersection Summary						
Average Delay	0.0					
Intersection Capacity Utilization	83.9%		ICU Level of Service		E	
Analysis Period (min)	15					

Queues

144: North Pointe Access 2 & US 29 (N)

07/22/2021





















Lane Group	EBT	WBR	NBT	NBR
Lane Group Flow (vph)	11	112	1184	60
v/c Ratio	0.10	0.30	0.41	0.04
Control Delay	43.1	2.1	1.9	0.3
Queue Delay	0.0	0.0	0.0	0.0
Total Delay	43.1	2.1	1.9	0.3
Queue Length 50th (ft)	7	0	60	0
Queue Length 95th (ft)	m8	0	78	4
Internal Link Dist (ft)	27		197	
Turn Bay Length (ft)				400
Base Capacity (vph)	371	733	2880	1400
Starvation Cap Reductn	0	0	0	0
Spillback Cap Reductn	0	0	0	0
Storage Cap Reductn	0	0	0	0
Reduced v/c Ratio	0.03	0.15	0.41	0.04

Intersection Summary

m Volume for 95th percentile queue is metered by upstream signal.

HCM Signalized Intersection Capacity Analysis
 144: North Pointe Access 2 & US 29 (N)

07/22/2021

												
Movement	EBL	EBT	EBR	WBL	WBT	WBR	NBL	NBT	NBR	SBL	SBT	SBR
Lane Configurations						 		 				
Traffic Volume (vph)	0	10	0	0	0	106	0	1125	57	0	0	0
Future Volume (vph)	0	10	0	0	0	106	0	1125	57	0	0	0
Ideal Flow (vphpl)	1900	1900	1900	1900	1900	1900	1900	1900	1900	1900	1900	1900
Total Lost time (s)		4.5				4.5		4.5	4.5			
Lane Util. Factor		1.00				0.88		0.95	1.00			
Frt		1.00				0.85		1.00	0.85			
Flt Protected		1.00				1.00		1.00	1.00			
Satd. Flow (prot)		1900				2842		3343	1615			
Flt Permitted		1.00				1.00		1.00	1.00			
Satd. Flow (perm)		1900				2842		3343	1615			
Peak-hour factor, PHF	0.92	0.92	0.92	0.95	0.95	0.95	0.95	0.95	0.95	0.92	0.92	0.92
Adj. Flow (vph)	0	11	0	0	0	112	0	1184	60	0	0	0
RTOR Reduction (vph)	0	0	0	0	0	106	0	0	8	0	0	0
Lane Group Flow (vph)	0	11	0	0	0	6	0	1184	52	0	0	0
Heavy Vehicles (%)	0%	0%	0%	0%	0%	0%	0%	8%	0%	2%	2%	2%
Turn Type		NA				Perm		NA	Perm			
Protected Phases		4						2				
Permitted Phases	4					8			2			
Actuated Green, G (s)		6.2				6.2		94.8	94.8			
Effective Green, g (s)		6.2				6.2		94.8	94.8			
Actuated g/C Ratio		0.06				0.06		0.86	0.86			
Clearance Time (s)		4.5				4.5		4.5	4.5			
Vehicle Extension (s)		3.0				3.0		3.0	3.0			
Lane Grp Cap (vph)		107				160		2881	1391			
v/s Ratio Prot		c0.01						c0.35				
v/s Ratio Perm						0.00			0.03			
v/c Ratio		0.10				0.04		0.41	0.04			
Uniform Delay, d1		49.3				49.1		1.6	1.1			
Progression Factor		0.87				1.00		0.88	0.88			
Incremental Delay, d2		0.2				0.1		0.4	0.0			
Delay (s)		42.8				49.2		1.8	1.0			
Level of Service		D				D		A	A			
Approach Delay (s)		42.8			49.2			1.8			0.0	
Approach LOS		D			D			A			A	
Intersection Summary												
HCM 2000 Control Delay			6.0				HCM 2000 Level of Service		A			
HCM 2000 Volume to Capacity ratio			0.39									
Actuated Cycle Length (s)			110.0				Sum of lost time (s)		9.0			
Intersection Capacity Utilization			77.2%				ICU Level of Service		D			
Analysis Period (min)			15									
c	Critical Lane Group											

Queues

145: US 29 (S) & Lewis and Clark Dr

07/22/2021

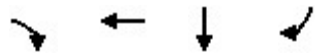

Lane Group	EBR	WBT	SBT	SBR
Lane Group Flow (vph)	37	71	2615	197
v/c Ratio	0.16	0.44	0.88	0.14
Control Delay	31.4	56.2	5.1	0.5
Queue Delay	0.0	0.0	0.0	0.0
Total Delay	31.4	56.2	5.1	0.5
Queue Length 50th (ft)	7	50	160	1
Queue Length 95th (ft)	25	96	m198	m3
Internal Link Dist (ft)		36	215	
Turn Bay Length (ft)				450
Base Capacity (vph)	421	304	2980	1401
Starvation Cap Reductn	0	0	0	0
Spillback Cap Reductn	0	0	0	0
Storage Cap Reductn	0	0	0	0
Reduced v/c Ratio	0.09	0.23	0.88	0.14

Intersection Summary

m Volume for 95th percentile queue is metered by upstream signal.

HCM Signalized Intersection Capacity Analysis
 145: US 29 (S) & Lewis and Clark Dr

07/22/2021



Movement	EBL	EBT	EBR	WBL	WBT	WBR	NBL	NBT	NBR	SBL	SBT	SBR
Lane Configurations			TT		T						TT	T
Traffic Volume (vph)	0	0	35	0	65	0	0	0	0	0	2484	187
Future Volume (vph)	0	0	35	0	65	0	0	0	0	0	2484	187
Ideal Flow (vphpl)	1900	1900	1900	1900	1900	1900	1900	1900	1900	1900	1900	1900
Total Lost time (s)			4.5		4.5						4.5	4.5
Lane Util. Factor			0.88		1.00						0.95	1.00
Frt			0.85		1.00						1.00	0.85
Flt Protected			1.00		1.00						1.00	1.00
Satd. Flow (prot)			2493		1863						3471	1599
Flt Permitted			1.00		1.00						1.00	1.00
Satd. Flow (perm)			2493		1863						3471	1599
Peak-hour factor, PHF	0.95	0.95	0.95	0.92	0.92	0.92	0.92	0.92	0.92	0.95	0.95	0.95
Adj. Flow (vph)	0	0	37	0	71	0	0	0	0	0	2615	197
RTOR Reduction (vph)	0	0	15	0	0	0	0	0	0	0	0	31
Lane Group Flow (vph)	0	0	22	0	71	0	0	0	0	0	2615	166
Heavy Vehicles (%)	0%	0%	14%	0%	2%	0%	2%	2%	2%	0%	4%	1%
Turn Type			Perm		NA						NA	Perm
Protected Phases					8						6	
Permitted Phases			4	8								6
Actuated Green, G (s)			8.3		8.3						92.7	92.7
Effective Green, g (s)			8.3		8.3						92.7	92.7
Actuated g/C Ratio			0.08		0.08						0.84	0.84
Clearance Time (s)			4.5		4.5						4.5	4.5
Vehicle Extension (s)			3.0		3.0						3.0	3.0
Lane Grp Cap (vph)			188		140						2925	1347
v/s Ratio Prot					c0.04						c0.75	
v/s Ratio Perm			0.01									0.10
v/c Ratio			0.12		0.51						0.89	0.12
Uniform Delay, d1			47.4		48.9						5.5	1.5
Progression Factor			1.00		1.03						0.41	1.25
Incremental Delay, d2			0.3		2.7						1.8	0.1
Delay (s)			47.7		52.8						4.1	2.0
Level of Service			D		D						A	A
Approach Delay (s)		47.7			52.8			0.0			3.9	
Approach LOS		D			D			A			A	
Intersection Summary												
HCM 2000 Control Delay			5.7		HCM 2000 Level of Service			A				
HCM 2000 Volume to Capacity ratio			0.86									
Actuated Cycle Length (s)			110.0		Sum of lost time (s)			9.0				
Intersection Capacity Utilization			112.0%		ICU Level of Service			H				
Analysis Period (min)			15									
c Critical Lane Group												

HCM Unsignalized Intersection Capacity Analysis
 146: US 29 (N)

07/22/2021



Movement	EBL	EBR	NBL	NBT	SBT	SBR
Lane Configurations						
Traffic Volume (veh/h)	0	0	65	1182	0	0
Future Volume (Veh/h)	0	0	65	1182	0	0
Sign Control	Stop			Free	Free	
Grade	0%			0%	0%	
Peak Hour Factor	0.92	0.92	0.95	0.95	0.95	0.95
Hourly flow rate (vph)	0	0	68	1244	0	0
Pedestrians						
Lane Width (ft)						
Walking Speed (ft/s)						
Percent Blockage						
Right turn flare (veh)						
Median type				None	None	
Median storage (veh)						
Upstream signal (ft)				918	277	
pX, platoon unblocked	0.94					
vC, conflicting volume	758	0	0			
vC1, stage 1 conf vol						
vC2, stage 2 conf vol						
vCu, unblocked vol	618	0	0			
tC, single (s)	6.8	6.9	4.1			
tC, 2 stage (s)						
tF (s)	3.5	3.3	2.2			
p0 queue free %	100	100	96			
cM capacity (veh/h)	380	1084	1622			
Direction, Lane #	NB 1	NB 2	NB 3			
Volume Total	68	622	622			
Volume Left	68	0	0			
Volume Right	0	0	0			
cSH	1622	1700	1700			
Volume to Capacity	0.04	0.37	0.37			
Queue Length 95th (ft)	3	0	0			
Control Delay (s)	7.3	0.0	0.0			
Lane LOS	A					
Approach Delay (s)	0.4					
Approach LOS						
Intersection Summary						
Average Delay			0.4			
Intersection Capacity Utilization			116.3%	ICU Level of Service	H	
Analysis Period (min)			15			

HCM Unsignalized Intersection Capacity Analysis
 147: US 29 (S) & Lewis and Clark U-Turn S

07/22/2021



Movement	WBL	WBR	NBT	NBR	SBL	SBT
Lane Configurations					↘	↕↕
Traffic Volume (veh/h)	0	0	0	0	26	2437
Future Volume (Veh/h)	0	0	0	0	26	2437
Sign Control	Stop		Free			Free
Grade	0%		0%			0%
Peak Hour Factor	0.92	0.92	0.92	0.92	0.92	0.92
Hourly flow rate (vph)	0	0	0	0	28	2649
Pedestrians						
Lane Width (ft)						
Walking Speed (ft/s)						
Percent Blockage						
Right turn flare (veh)						
Median type	None			None		
Median storage (veh)						
Upstream signal (ft)	968			904		
pX, platoon unblocked	0.18					
vC, conflicting volume	1380	0	0			
vC1, stage 1 conf vol						
vC2, stage 2 conf vol						
vCu, unblocked vol	0	0	0			
tC, single (s)	6.8	6.9	4.2			
tC, 2 stage (s)						
tF (s)	3.5	3.3	2.2			
p0 queue free %	100	100	98			
cM capacity (veh/h)	177	1084	1600			
Direction, Lane #	SB 1	SB 2	SB 3			
Volume Total	28	1324	1324			
Volume Left	28	0	0			
Volume Right	0	0	0			
cSH	1600	1700	1700			
Volume to Capacity	0.02	0.78	0.78			
Queue Length 95th (ft)	1	0	0			
Control Delay (s)	7.3	0.0	0.0			
Lane LOS	A					
Approach Delay (s)	0.1					
Approach LOS						
Intersection Summary						
Average Delay	0.1					
Intersection Capacity Utilization	54.6%		ICU Level of Service		A	
Analysis Period (min)	15					

Queues

148: US 29 (N) & Lewis and Clark U-Turn S

07/22/2021



Lane Group	EBL	NBT
Lane Group Flow (vph)	28	1266
v/c Ratio	0.14	0.41
Control Delay	0.8	1.3
Queue Delay	0.0	0.0
Total Delay	0.8	1.3
Queue Length 50th (ft)	0	61
Queue Length 95th (ft)	m0	71
Internal Link Dist (ft)	29	889
Turn Bay Length (ft)		
Base Capacity (vph)	398	3078
Starvation Cap Reductn	0	0
Spillback Cap Reductn	0	0
Storage Cap Reductn	0	0
Reduced v/c Ratio	0.07	0.41

Intersection Summary

m Volume for 95th percentile queue is metered by upstream signal.

HCM Signalized Intersection Capacity Analysis
 148: US 29 (N) & Lewis and Clark U-Turn S

07/22/2021



Movement	EBL	EBR	NBL	NBT	SBT	SBR
Lane Configurations	↶			↕		
Traffic Volume (vph)	26	0	0	1165	0	0
Future Volume (vph)	26	0	0	1165	0	0
Ideal Flow (vphpl)	1900	1900	1900	1900	1900	1900
Total Lost time (s)	4.5			4.5		
Lane Util. Factor	1.00			0.95		
Frt	1.00			1.00		
Flt Protected	0.95			1.00		
Satd. Flow (prot)	1719			3343		
Flt Permitted	0.95			1.00		
Satd. Flow (perm)	1719			3343		
Peak-hour factor, PHF	0.92	0.92	0.92	0.92	0.92	0.92
Adj. Flow (vph)	28	0	0	1266	0	0
RTOR Reduction (vph)	27	0	0	0	0	0
Lane Group Flow (vph)	1	0	0	1266	0	0
Heavy Vehicles (%)	5%	0%	0%	8%	2%	2%
Turn Type	Prot			NA		
Protected Phases	4			2		
Permitted Phases						
Actuated Green, G (s)	3.3			97.7		
Effective Green, g (s)	3.3			97.7		
Actuated g/C Ratio	0.03			0.89		
Clearance Time (s)	4.5			4.5		
Vehicle Extension (s)	3.0			3.0		
Lane Grp Cap (vph)	51			2969		
v/s Ratio Prot	c0.00			c0.38		
v/s Ratio Perm						
v/c Ratio	0.02			0.43		
Uniform Delay, d1	51.8			1.1		
Progression Factor	1.00			0.82		
Incremental Delay, d2	0.1			0.4		
Delay (s)	51.8			1.3		
Level of Service	D			A		
Approach Delay (s)	51.8			1.3	0.0	
Approach LOS	D			A	A	

Intersection Summary			
HCM 2000 Control Delay	2.4	HCM 2000 Level of Service	A
HCM 2000 Volume to Capacity ratio	0.41		
Actuated Cycle Length (s)	110.0	Sum of lost time (s)	9.0
Intersection Capacity Utilization	55.0%	ICU Level of Service	A
Analysis Period (min)	15		
c Critical Lane Group			

Queues

151: US 29 (S) & U-Turn Access

07/22/2021

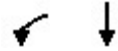

Lane Group	WBL	SBT
Lane Group Flow (vph)	20	2622
v/c Ratio	0.18	0.81
Control Delay	41.9	4.0
Queue Delay	0.0	0.0
Total Delay	41.9	4.0
Queue Length 50th (ft)	9	0
Queue Length 95th (ft)	m28	308
Internal Link Dist (ft)	22	888
Turn Bay Length (ft)		
Base Capacity (vph)	302	3232
Starvation Cap Reductn	0	0
Spillback Cap Reductn	0	0
Storage Cap Reductn	0	0
Reduced v/c Ratio	0.07	0.81

Intersection Summary

m Volume for 95th percentile queue is metered by upstream signal.

HCM Signalized Intersection Capacity Analysis
 151: US 29 (S) & U-Turn Access

07/22/2021



Movement	WBL	WBR	NBT	NBR	SBL	SBT
Lane Configurations	↰					↱↱
Traffic Volume (vph)	19	0	0	0	0	2438
Future Volume (vph)	19	0	0	0	0	2438
Ideal Flow (vphpl)	1900	1900	1900	1900	1900	1900
Total Lost time (s)						4.5
Lane Util. Factor						0.95
Frt						1.00
Flt Protected						1.00
Satd. Flow (prot)						3438
Flt Permitted						1.00
Satd. Flow (perm)						3438
Peak-hour factor, PHF	0.93	0.93	0.93	0.93	0.93	0.93
Adj. Flow (vph)	20	0	0	0	0	2622
RTOR Reduction (vph)	9	0	0	0	0	0
Lane Group Flow (vph)	11	0	0	0	0	2622
Heavy Vehicles (%)	0%	0%	0%	0%	0%	5%
Turn Type	Prot					NA
Protected Phases	8					6
Permitted Phases						
Actuated Green, G (s)	3.0					98.0
Effective Green, g (s)	3.0					98.0
Actuated g/C Ratio	0.03					0.89
Clearance Time (s)	4.5					4.5
Vehicle Extension (s)	3.0					3.0
Lane Grp Cap (vph)	49					3062
v/s Ratio Prot	c0.01					c0.76
v/s Ratio Perm						
v/c Ratio	0.23					0.86
Uniform Delay, d1	52.4					2.8
Progression Factor	1.14					0.75
Incremental Delay, d2	2.2					1.7
Delay (s)	61.9					3.7
Level of Service	E					A
Approach Delay (s)	61.9		0.0		3.7	
Approach LOS	E		A		A	
Intersection Summary						
HCM 2000 Control Delay			4.2		HCM 2000 Level of Service A	
HCM 2000 Volume to Capacity ratio			0.84			
Actuated Cycle Length (s)			110.0		Sum of lost time (s) 9.0	
Intersection Capacity Utilization			105.9%		ICU Level of Service G	
Analysis Period (min)			15			
c Critical Lane Group						

HCM Unsignalized Intersection Capacity Analysis
 152: US 29 (N) & U-Turn Access

07/22/2021



Movement	EBL	EBR	NBL	NBT	SBT	SBR
Lane Configurations			↖↖	↕↕		
Traffic Volume (veh/h)	0	0	19	1138	0	0
Future Volume (Veh/h)	0	0	19	1138	0	0
Sign Control	Stop		Free		Free	
Grade	0%		0%		0%	
Peak Hour Factor	0.93	0.93	0.93	0.93	0.93	0.93
Hourly flow rate (vph)	0	0	20	1224	0	0
Pedestrians						
Lane Width (ft)						
Walking Speed (ft/s)						
Percent Blockage						
Right turn flare (veh)						
Median type			None	None		
Median storage (veh)						
Upstream signal (ft)			522	969		
pX, platoon unblocked	0.92					
vC, conflicting volume	652	0	0			
vC1, stage 1 conf vol						
vC2, stage 2 conf vol						
vCu, unblocked vol	461	0	0			
tC, single (s)	6.8	6.9	4.1			
tC, 2 stage (s)						
tF (s)	3.5	3.3	2.2			
p0 queue free %	100	100	99			
cM capacity (veh/h)	488	1091	1636			
Direction, Lane #	NB 1	NB 2	NB 3	NB 4		
Volume Total	10	10	612	612		
Volume Left	10	10	0	0		
Volume Right	0	0	0	0		
cSH	1636	1636	1700	1700		
Volume to Capacity	0.01	0.01	0.36	0.36		
Queue Length 95th (ft)	1	1	0	0		
Control Delay (s)	7.2	7.2	0.0	0.0		
Lane LOS	A	A				
Approach Delay (s)	0.1					
Approach LOS						
Intersection Summary						
Average Delay			0.1			
Intersection Capacity Utilization			105.9%	ICU Level of Service	G	
Analysis Period (min)			15			

HCM Unsignalized Intersection Capacity Analysis
 161: Northside Dr E & US 29 (S)

07/22/2021



Movement	WBL	WBR	NBT	NBR	SBL	SBT
Lane Configurations					↖ ↗	↕ ↕
Traffic Volume (veh/h)	0	0	0	0	23	2539
Future Volume (Veh/h)	0	0	0	0	23	2539
Sign Control	Stop		Free		Free	
Grade	0%		0%		0%	
Peak Hour Factor	0.93	0.93	0.93	0.93	0.93	0.93
Hourly flow rate (vph)	0	0	0	0	25	2730
Pedestrians						
Lane Width (ft)						
Walking Speed (ft/s)						
Percent Blockage						
Right turn flare (veh)						
Median type	None			None		
Median storage (veh)						
Upstream signal (ft)	518					
pX, platoon unblocked	0.12					
vC, conflicting volume	1415	0	0			
vC1, stage 1 conf vol						
vC2, stage 2 conf vol						
vCu, unblocked vol	0	0	0			
tC, single (s)	6.8	6.9	4.1			
tC, 2 stage (s)						
tF (s)	3.5	3.3	2.2			
p0 queue free %	100	100	98			
cM capacity (veh/h)	123	1091	1636			
Direction, Lane #	SB 1	SB 2	SB 3	SB 4		
Volume Total	12	12	1365	1365		
Volume Left	12	12	0	0		
Volume Right	0	0	0	0		
cSH	1636	1636	1700	1700		
Volume to Capacity	0.02	0.02	0.80	0.80		
Queue Length 95th (ft)	1	1	0	0		
Control Delay (s)	7.2	7.2	0.0	0.0		
Lane LOS	A	A				
Approach Delay (s)	0.1					
Approach LOS						
Intersection Summary						
Average Delay	0.1					
Intersection Capacity Utilization	92.5%		ICU Level of Service		F	
Analysis Period (min)	15					

Queues

162: US 29 (N) & Northside Dr E/North Pointe Access 1

07/22/2021



Lane Group	EBT	WBR	NBT	NBR
Lane Group Flow (vph)	25	217	1243	59
v/c Ratio	0.17	0.60	0.43	0.04
Control Delay	42.8	17.9	2.6	0.5
Queue Delay	0.0	0.0	0.0	0.0
Total Delay	42.8	17.9	2.6	0.5
Queue Length 50th (ft)	8	12	70	0
Queue Length 95th (ft)	m11	51	127	6
Internal Link Dist (ft)	14		174	
Turn Bay Length (ft)				300
Base Capacity (vph)	456	735	2890	1379
Starvation Cap Reductn	0	0	0	0
Spillback Cap Reductn	0	0	0	0
Storage Cap Reductn	0	0	0	0
Reduced v/c Ratio	0.05	0.30	0.43	0.04

Intersection Summary

m Volume for 95th percentile queue is metered by upstream signal.

HCM Signalized Intersection Capacity Analysis
 162: US 29 (N) & Northside Dr E/North Pointe Access 1

















07/22/2021



Movement	EBL	EBT	EBR	WBL	WBT	WBR	NBL	NBT	NBR	SBL	SBT	SBR
Lane Configurations		↕↕				↗↗		↕↕	↗			
Traffic Volume (vph)	0	23	0	0	0	202	0	1156	55	0	0	0
Future Volume (vph)	0	23	0	0	0	202	0	1156	55	0	0	0
Ideal Flow (vphpl)	1900	1900	1900	1900	1900	1900	1900	1900	1900	1900	1900	1900
Total Lost time (s)		4.5				4.5		4.5	4.5			
Lane Util. Factor		0.95				0.88		0.95	1.00			
Frt		1.00				0.85		1.00	0.85			
Flt Protected		1.00				1.00		1.00	1.00			
Satd. Flow (prot)		2136				2760		3406	1615			
Flt Permitted		1.00				1.00		1.00	1.00			
Satd. Flow (perm)		2136				2760		3406	1615			
Peak-hour factor, PHF	0.93	0.93	0.93	0.93	0.93	0.93	0.93	0.93	0.93	0.93	0.93	0.93
Adj. Flow (vph)	0	25	0	0	0	217	0	1243	59	0	0	0
RTOR Reduction (vph)	0	0	0	0	0	172	0	0	9	0	0	0
Lane Group Flow (vph)	0	25	0	0	0	45	0	1243	50	0	0	0
Heavy Vehicles (%)	0%	69%	0%	0%	0%	3%	0%	6%	0%	0%	0%	0%
Turn Type		NA				Perm		NA	Perm			
Protected Phases		4						2				
Permitted Phases	4					8			2			
Actuated Green, G (s)		7.6				7.6		93.4	93.4			
Effective Green, g (s)		7.6				7.6		93.4	93.4			
Actuated g/C Ratio		0.07				0.07		0.85	0.85			
Clearance Time (s)		4.5				4.5		4.5	4.5			
Vehicle Extension (s)		3.0				3.0		3.0	3.0			
Lane Grp Cap (vph)		147				190		2892	1371			
v/s Ratio Prot		0.01						c0.36				
v/s Ratio Perm						c0.02			0.03			
v/c Ratio		0.17				0.24		0.43	0.04			
Uniform Delay, d1		48.2				48.5		2.0	1.3			
Progression Factor		0.88				1.00		1.00	1.00			
Incremental Delay, d2		0.3				0.6		0.5	0.0			
Delay (s)		42.6				49.1		2.4	1.3			
Level of Service		D				D		A	A			
Approach Delay (s)		42.6			49.1			2.4			0.0	
Approach LOS		D			D			A			A	
Intersection Summary												
HCM 2000 Control Delay			9.6				HCM 2000 Level of Service		A			
HCM 2000 Volume to Capacity ratio			0.42									
Actuated Cycle Length (s)			110.0				Sum of lost time (s)		9.0			
Intersection Capacity Utilization			118.0%				ICU Level of Service		H			
Analysis Period (min)			15									
c Critical Lane Group												

HCM Unsignalized Intersection Capacity Analysis
 163: US 29 (S) & Northside Dr W

07/22/2021

												
Movement	EBL	EBT	EBR	WBL	WBT	WBR	NBL	NBT	NBR	SBL	SBT	SBR
Lane Configurations											 	
Traffic Volume (veh/h)	0	0	12	0	5	0	0	0	0	0	2528	11
Future Volume (Veh/h)	0	0	12	0	5	0	0	0	0	0	2528	11
Sign Control		Stop			Stop			Free			Free	
Grade		0%			0%			0%			0%	
Peak Hour Factor	0.93	0.93	0.93	0.93	0.93	0.93	0.93	0.93	0.93	0.93	0.93	0.93
Hourly flow rate (vph)	0	0	13	0	5	0	0	0	0	0	2718	12
Pedestrians												
Lane Width (ft)												
Walking Speed (ft/s)												
Percent Blockage												
Right turn flare (veh)												
Median type												
								None				None
Median storage (veh)												
Upstream signal (ft)												
												769
pX, platoon unblocked	0.13	0.13	0.13	0.13	0.13		0.13					
vC, conflicting volume	2720	2718	1359	1372	2730	0	2730			0		
vC1, stage 1 conf vol												
vC2, stage 2 conf vol												
vCu, unblocked vol	782	762	0	0	857	0	857			0		
tC, single (s)	7.5	6.5	7.7	7.5	6.5	6.9	4.1			4.1		
tC, 2 stage (s)												
tF (s)	3.5	4.0	3.7	3.5	4.0	3.3	2.2			2.2		
p0 queue free %	100	100	89	100	86	100	100			100		
cM capacity (veh/h)	33	42	123	116	37	1091	100			1636		
Direction, Lane #												
	EB 1	WB 1	SB 1	SB 2	SB 3							
Volume Total	13	5	1359	1359	12							
Volume Left	0	0	0	0	0							
Volume Right	13	0	0	0	12							
cSH	123	37	1700	1700	1700							
Volume to Capacity	0.11	0.14	0.80	0.80	0.01							
Queue Length 95th (ft)	9	11	0	0	0							
Control Delay (s)	37.8	117.1	0.0	0.0	0.0							
Lane LOS	E	F										
Approach Delay (s)	37.8	117.1	0.0									
Approach LOS	E	F										
Intersection Summary												
Average Delay			0.4									
Intersection Capacity Utilization			79.9%		ICU Level of Service					D		
Analysis Period (min)			15									

HCM Unsignalized Intersection Capacity Analysis
 164: US 29 (N) & Northside Dr W

07/22/2021



Movement	EBL	EBR	NBL	NBT	SBT	SBR
Lane Configurations			↙	↑↑		
Traffic Volume (veh/h)	0	0	5	1211	0	0
Future Volume (Veh/h)	0	0	5	1211	0	0
Sign Control	Stop			Free	Free	
Grade	0%			0%	0%	
Peak Hour Factor	0.92	0.93	0.93	0.93	0.93	0.93
Hourly flow rate (vph)	0	0	5	1302	0	0
Pedestrians						
Lane Width (ft)						
Walking Speed (ft/s)						
Percent Blockage						
Right turn flare (veh)						
Median type				None	None	
Median storage (veh)						
Upstream signal (ft)						254
pX, platoon unblocked						
vC, conflicting volume	661	0	0			
vC1, stage 1 conf vol						
vC2, stage 2 conf vol						
vCu, unblocked vol	661	0	0			
tC, single (s)	6.8	6.9	4.1			
tC, 2 stage (s)						
tF (s)	3.5	3.3	2.2			
p0 queue free %	100	100	100			
cM capacity (veh/h)	399	1091	1622			
Direction, Lane #	NB 1	NB 2	NB 3			
Volume Total	5	651	651			
Volume Left	5	0	0			
Volume Right	0	0	0			
cSH	1622	1700	1700			
Volume to Capacity	0.00	0.38	0.38			
Queue Length 95th (ft)	0	0	0			
Control Delay (s)	7.2	0.0	0.0			
Lane LOS	A					
Approach Delay (s)	0.0					
Approach LOS						
Intersection Summary						
Average Delay			0.0			
Intersection Capacity Utilization			79.9%	ICU Level of Service	D	
Analysis Period (min)			15			

HCM Unsignalized Intersection Capacity Analysis
 171: Airport Acres Rd (North) E & US 29 (S)

07/22/2021



Movement	WBL	WBR	NBT	NBR	SBL	SBT
Lane Configurations					↙	↕↕
Traffic Volume (veh/h)	0	0	0	0	1	2571
Future Volume (Veh/h)	0	0	0	0	1	2571
Sign Control	Stop		Free		Free	
Grade	0%		0%		0%	
Peak Hour Factor	0.93	0.93	0.93	0.93	0.93	0.93
Hourly flow rate (vph)	0	0	0	0	1	2765
Pedestrians						
Lane Width (ft)						
Walking Speed (ft/s)						
Percent Blockage						
Right turn flare (veh)						
Median type	None			None		
Median storage (veh)						
Upstream signal (ft)						
pX, platoon unblocked						
vC, conflicting volume	1384	0			0	
vC1, stage 1 conf vol						
vC2, stage 2 conf vol						
vCu, unblocked vol	1384	0			0	
tC, single (s)	6.8	6.9			4.1	
tC, 2 stage (s)						
tF (s)	3.5	3.3			2.2	
p0 queue free %	100	100			100	
cM capacity (veh/h)	137	1091			1636	
Direction, Lane #	SB 1	SB 2	SB 3			
Volume Total	1	1382	1382			
Volume Left	1	0	0			
Volume Right	0	0	0			
cSH	1636	1700	1700			
Volume to Capacity	0.00	0.81	0.81			
Queue Length 95th (ft)	0	0	0			
Control Delay (s)	7.2	0.0	0.0			
Lane LOS	A					
Approach Delay (s)	0.0					
Approach LOS						
Intersection Summary						
Average Delay	0.0					
Intersection Capacity Utilization	74.4%		ICU Level of Service		D	
Analysis Period (min)	15					

HCM Unsignalized Intersection Capacity Analysis
 172: Airport Acres Rd (North) E & US 29 (N)

07/22/2021



Movement	EBL	EBR	NBL	NBT	SBT	SBR
Lane Configurations	↶			↷		
Traffic Volume (veh/h)	1	0	0	1133	0	0
Future Volume (Veh/h)	1	0	0	1133	0	0
Sign Control	Stop			Free	Free	
Grade	0%			0%	0%	
Peak Hour Factor	0.93	0.93	0.93	0.93	0.93	0.93
Hourly flow rate (vph)	1	0	0	1218	0	0
Pedestrians						
Lane Width (ft)						
Walking Speed (ft/s)						
Percent Blockage						
Right turn flare (veh)						
Median type				None	None	
Median storage (veh)						
Upstream signal (ft)						
pX, platoon unblocked						
vC, conflicting volume	609	0	0			
vC1, stage 1 conf vol						
vC2, stage 2 conf vol						
vCu, unblocked vol	609	0	0			
tC, single (s)	6.8	6.9	4.1			
tC, 2 stage (s)						
tF (s)	3.5	3.3	2.2			
p0 queue free %	100	100	100			
cM capacity (veh/h)	427	1091	1636			
Direction, Lane #	EB 1	NB 1	NB 2			
Volume Total	1	609	609			
Volume Left	1	0	0			
Volume Right	0	0	0			
cSH	427	1700	1700			
Volume to Capacity	0.00	0.36	0.36			
Queue Length 95th (ft)	0	0	0			
Control Delay (s)	13.5	0.0	0.0			
Lane LOS	B					
Approach Delay (s)	13.5	0.0				
Approach LOS	B					
Intersection Summary						
Average Delay	0.0					
Intersection Capacity Utilization	41.3%			ICU Level of Service	A	
Analysis Period (min)	15					

HCM Unsignalized Intersection Capacity Analysis
 173: US 29 (S) & Airport Acres Rd (North) W

07/22/2021

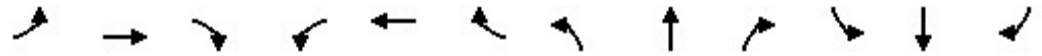

Movement	EBL	EBT	EBR	WBL	WBT	WBR	NBL	NBT	NBR	SBL	SBT	SBR
Lane Configurations			↗		↖						↕	↗
Traffic Volume (veh/h)	0	0	4	0	1	0	0	0	0	0	2570	1
Future Volume (Veh/h)	0	0	4	0	1	0	0	0	0	0	2570	1
Sign Control		Stop			Stop			Free			Free	
Grade		0%			0%			0%			0%	
Peak Hour Factor	0.93	0.93	0.93	0.93	0.93	0.93	0.93	0.93	0.93	0.93	0.93	0.93
Hourly flow rate (vph)	0	0	4	0	1	0	0	0	0	0	2763	1
Pedestrians												
Lane Width (ft)												
Walking Speed (ft/s)												
Percent Blockage												
Right turn flare (veh)												
Median type								None			None	
Median storage (veh)												
Upstream signal (ft)												
pX, platoon unblocked												
vC, conflicting volume	2764	2764	1382	1386	2764	0	2764			0		
vC1, stage 1 conf vol												
vC2, stage 2 conf vol												
vCu, unblocked vol	2764	2764	1382	1386	2764	0	2764			0		
tC, single (s)	7.5	6.5	6.9	7.5	6.5	6.9	4.1			4.1		
tC, 2 stage (s)												
tF (s)	3.5	4.0	3.3	3.5	4.0	3.3	2.2			2.2		
p0 queue free %	100	100	97	100	95	100	100			100		
cM capacity (veh/h)	9	20	136	101	20	1091	146			1636		
Direction, Lane #	EB 1	WB 1	SB 1	SB 2								
Volume Total	4	1	1842	922								
Volume Left	0	0	0	0								
Volume Right	4	0	0	1								
cSH	136	20	1700	1700								
Volume to Capacity	0.03	0.05	1.08	0.54								
Queue Length 95th (ft)	2	4	0	0								
Control Delay (s)	32.3	197.2	0.0	0.0								
Lane LOS	D	F										
Approach Delay (s)	32.3	197.2	0.0									
Approach LOS	D	F										
Intersection Summary												
Average Delay			0.1									
Intersection Capacity Utilization			81.1%		ICU Level of Service					D		
Analysis Period (min)			15									

HCM Unsignalized Intersection Capacity Analysis
 174: US 29 (N)

07/22/2021

























Movement	EBL	EBR	NBL	NBT	SBT	SBR
Lane Configurations						
Traffic Volume (veh/h)	0	0	1	1133	0	0
Future Volume (Veh/h)	0	0	1	1133	0	0
Sign Control	Stop			Free	Free	
Grade	0%			0%	0%	
Peak Hour Factor	0.93	0.93	0.93	0.93	0.93	0.93
Hourly flow rate (vph)	0	0	1	1218	0	0
Pedestrians						
Lane Width (ft)						
Walking Speed (ft/s)						
Percent Blockage						
Right turn flare (veh)						
Median type						
Median storage (veh)						
Upstream signal (ft)						
pX, platoon unblocked						
vC, conflicting volume	611	0	0			
vC1, stage 1 conf vol						
vC2, stage 2 conf vol						
vCu, unblocked vol	611	0	0			
tC, single (s)	6.8	6.9	4.1			
tC, 2 stage (s)						
tF (s)	3.5	3.3	2.2			
p0 queue free %	100	100	100			
cM capacity (veh/h)	430	1091	1636			
Direction, Lane #						
	NB 1	NB 2	NB 3			
Volume Total	1	609	609			
Volume Left	1	0	0			
Volume Right	0	0	0			
cSH	1636	1700	1700			
Volume to Capacity	0.00	0.36	0.36			
Queue Length 95th (ft)	0	0	0			
Control Delay (s)	7.2	0.0	0.0			
Lane LOS	A					
Approach Delay (s)	0.0					
Approach LOS						
Intersection Summary						
Average Delay			0.0			
Intersection Capacity Utilization			81.1%	ICU Level of Service		D
Analysis Period (min)			15			

HCM Unsignalized Intersection Capacity Analysis

1: US 29 & Deerfield Drive

07/22/2021

													
Movement	EBL	EBT	EBR	WBL	WBT	WBR	NBL	NBT	NBR	SBL	SBT	SBR	
Lane Configurations													
Traffic Volume (veh/h)	58	1	26	10	5	21	38	1652	28	8	1006	53	
Future Volume (Veh/h)	58	1	26	10	5	21	38	1652	28	8	1006	53	
Sign Control		Stop			Stop			Free			Free		
Grade		0%			0%			0%			0%		
Peak Hour Factor	0.96	0.96	0.96	0.96	0.96	0.96	0.96	0.96	0.96	0.96	0.96	0.96	
Hourly flow rate (vph)	60	1	27	10	5	22	40	1721	29	8	1048	55	
Pedestrians													
Lane Width (ft)													
Walking Speed (ft/s)													
Percent Blockage													
Right turn flare (veh)													
			7										
Median type													
								Raised			Raised		
Median storage (veh)													
								2			2		
Upstream signal (ft)													
								770					
pX, platoon unblocked	0.58	0.58		0.58	0.58	0.58					0.58		
vC, conflicting volume	2029	2894	524	2342	2920	860	1103				1750		
vC1, stage 1 conf vol	1064	1064		1801	1801								
vC2, stage 2 conf vol	965	1830		540	1119								
vCu, unblocked vol	1320	2817	524	1860	2862	0	1103				837		
tC, single (s)	7.5	6.5	6.9	7.5	7.0	6.9	4.1				4.1		
tC, 2 stage (s)	6.5	5.5		6.5	6.0								
tF (s)	3.5	4.0	3.3	3.5	4.2	3.3	2.2				2.2		
p0 queue free %	72	99	95	93	96	97	94				98		
cM capacity (veh/h)	212	141	503	145	116	630	640				466		
Direction, Lane #													
	EB 1	WB 1	NB 1	NB 2	NB 3	NB 4	SB 1	SB 2	SB 3	SB 4			
Volume Total	88	37	40	860	860	29	8	524	524	55			
Volume Left	60	10	40	0	0	0	8	0	0	0			
Volume Right	27	22	0	0	0	29	0	0	0	55			
cSH	304	251	640	1700	1700	1700	466	1700	1700	1700			
Volume to Capacity	0.29	0.15	0.06	0.51	0.51	0.02	0.02	0.31	0.31	0.03			
Queue Length 95th (ft)	29	13	5	0	0	0	1	0	0	0			
Control Delay (s)	23.9	21.8	11.0	0.0	0.0	0.0	12.9	0.0	0.0	0.0			
Lane LOS	C	C	B				B						
Approach Delay (s)	23.9	21.8	0.2				0.1						
Approach LOS	C	C											
Intersection Summary													
Average Delay			1.1										
Intersection Capacity Utilization			61.7%		ICU Level of Service				B				
Analysis Period (min)			15										

Queues

2: US 29 & Matthew Mill Road

07/22/2021



Lane Group	EBT	EBR	WBL	WBT	WBR	NBL	NBT	NBR	SBL	SBT	SBR
Lane Group Flow (vph)	154	120	108	111	59	214	1602	239	92	925	75
v/c Ratio	0.89	0.32	0.77	0.75	0.18	0.77	0.89	0.25	0.83	0.63	0.09
Control Delay	95.0	2.2	85.9	83.2	1.2	60.2	41.4	6.3	105.4	30.8	0.2
Queue Delay	0.0	0.0	0.0	0.0	0.0	0.0	2.6	0.0	0.0	0.0	0.0
Total Delay	95.0	2.2	85.9	83.2	1.2	60.2	44.1	6.3	105.4	30.8	0.2
Queue Length 50th (ft)	118	0	87	89	0	148	645	26	72	300	0
Queue Length 95th (ft)	#240	0	#184	#183	0	228	728	68	#173	387	0
Internal Link Dist (ft)	263			737			534			690	
Turn Bay Length (ft)			600		575	300		355	625		
Base Capacity (vph)	180	385	147	154	326	330	1796	944	111	1469	793
Starvation Cap Reductn	0	0	0	0	0	0	110	0	0	0	0
Spillback Cap Reductn	0	0	0	0	0	0	0	0	0	0	0
Storage Cap Reductn	0	0	0	0	0	0	0	0	0	0	0
Reduced v/c Ratio	0.86	0.31	0.73	0.72	0.18	0.65	0.95	0.25	0.83	0.63	0.09

Intersection Summary

95th percentile volume exceeds capacity, queue may be longer.
 Queue shown is maximum after two cycles.

HCM Signalized Intersection Capacity Analysis

2: US 29 & Matthew Mill Road

07/22/2021



Movement	EBL	EBT	EBR	WBL	WBT	WBR	NBL	NBT	NBR	SBL	SBT	SBR
Lane Configurations		↖	↗	↖	↖	↗	↖	↕	↗	↖	↕	↗
Traffic Volume (vph)	94	52	114	141	67	56	203	1522	227	87	879	71
Future Volume (vph)	94	52	114	141	67	56	203	1522	227	87	879	71
Ideal Flow (vphpl)	1900	1900	1900	1900	1900	1900	1900	1900	1900	1900	1900	1900
Total Lost time (s)		6.5	6.5	6.5	6.5	6.5	6.0	7.0	7.0	6.0	7.0	7.0
Lane Util. Factor		1.00	1.00	0.95	0.95	1.00	1.00	0.95	1.00	1.00	0.95	1.00
Frt		1.00	0.85	1.00	1.00	0.85	1.00	1.00	0.85	1.00	1.00	0.85
Flt Protected		0.97	1.00	0.95	0.98	1.00	0.95	1.00	1.00	0.95	1.00	1.00
Satd. Flow (prot)		1841	1599	1681	1760	1599	1805	3505	1615	1805	3505	1615
Flt Permitted		0.74	1.00	0.95	0.98	1.00	0.95	1.00	1.00	0.95	1.00	1.00
Satd. Flow (perm)		1399	1599	1681	1760	1599	1805	3505	1615	1805	3505	1615
Peak-hour factor, PHF	0.95	0.95	0.95	0.95	0.95	0.95	0.95	0.95	0.95	0.95	0.95	0.95
Adj. Flow (vph)	99	55	120	148	71	59	214	1602	239	92	925	75
RTOR Reduction (vph)	0	0	105	0	0	54	0	0	117	0	0	44
Lane Group Flow (vph)	0	154	15	108	111	5	214	1602	122	92	925	31
Heavy Vehicles (%)	0%	0%	1%	2%	0%	1%	0%	3%	0%	0%	3%	0%
Turn Type	Perm	NA	Prot	Split	NA	Prot	Prot	NA	Prot	Prot	NA	Prot
Protected Phases		4	4	3	3	3	5	2	2	1	6	6
Permitted Phases	4											
Actuated Green, G (s)		15.0	15.0	10.1	10.1	10.1	18.6	61.5	61.5	7.4	50.3	50.3
Effective Green, g (s)		15.0	15.0	10.1	10.1	10.1	18.6	61.5	61.5	7.4	50.3	50.3
Actuated g/C Ratio		0.12	0.12	0.08	0.08	0.08	0.16	0.51	0.51	0.06	0.42	0.42
Clearance Time (s)		6.5	6.5	6.5	6.5	6.5	6.0	7.0	7.0	6.0	7.0	7.0
Vehicle Extension (s)		3.0	3.0	3.0	3.0	3.0	3.0	6.0	6.0	3.0	6.0	6.0
Lane Grp Cap (vph)		174	199	141	148	134	279	1796	827	111	1469	676
v/s Ratio Prot			0.01	c0.06	0.06	0.00	c0.12	c0.46	0.08	0.05	0.26	0.02
v/s Ratio Perm	c0.11											
v/c Ratio		0.89	0.08	0.77	0.75	0.04	0.77	0.89	0.15	0.83	0.63	0.05
Uniform Delay, d1		51.7	46.4	53.8	53.7	50.5	48.6	26.3	15.4	55.7	27.5	20.6
Progression Factor		1.00	1.00	1.00	1.00	1.00	0.94	1.33	2.91	1.00	1.00	1.00
Incremental Delay, d2		37.4	0.2	21.6	19.0	0.1	9.6	5.8	0.3	37.6	2.1	0.1
Delay (s)		89.0	46.5	75.4	72.8	50.6	55.3	40.8	45.1	93.2	29.6	20.8
Level of Service		F	D	E	E	D	E	D	D	F	C	C
Approach Delay (s)		70.4			69.1			42.8			34.3	
Approach LOS		E			E			D			C	

Intersection Summary

HCM 2000 Control Delay	44.3	HCM 2000 Level of Service	D
HCM 2000 Volume to Capacity ratio	0.89		
Actuated Cycle Length (s)	120.0	Sum of lost time (s)	26.0
Intersection Capacity Utilization	78.8%	ICU Level of Service	D
Analysis Period (min)	15		
c Critical Lane Group			

Queues

3: US 29 & Heatherton Drive

07/22/2021



Lane Group	EBT	EBR	WBR	NBL	NBT	SBT	SBR
Lane Group Flow (vph)	2	22	33	69	2081	1176	17
v/c Ratio	0.02	0.08	0.25	0.46	0.62	0.40	0.01
Control Delay	0.0	0.5	10.3	46.6	3.7	0.7	0.0
Queue Delay	0.0	0.0	0.0	0.0	0.8	0.1	0.0
Total Delay	0.0	0.5	10.3	46.6	4.5	0.7	0.0
Queue Length 50th (ft)	0	0	0	49	300	10	0
Queue Length 95th (ft)	0	0	17	m64	m302	14	m0
Internal Link Dist (ft)	96				1998	534	
Turn Bay Length (ft)				550			
Base Capacity (vph)	95	436	299	170	3334	2943	1327
Starvation Cap Reductn	0	0	0	0	0	527	0
Spillback Cap Reductn	0	0	12	0	848	0	0
Storage Cap Reductn	0	0	0	0	0	0	0
Reduced v/c Ratio	0.02	0.05	0.11	0.41	0.84	0.49	0.01



















Intersection Summary

m Volume for 95th percentile queue is metered by upstream signal.

HCM Signalized Intersection Capacity Analysis



















3: US 29 & Heatherton Drive

07/22/2021

												
Movement	EBL	EBT	EBR	WBL	WBT	WBR	NBL	NBT	NBR	SBL	SBT	SBR
Lane Configurations												
Traffic Volume (vph)	0	0	23	0	0	31	66	1953	24	0	1117	16
Future Volume (vph)	0	0	23	0	0	31	66	1953	24	0	1117	16
Ideal Flow (vphpl)	1900	1900	1900	1900	1900	1900	1900	1900	1900	1900	1900	1900
Total Lost time (s)		4.0	4.5			4.5	4.5	4.5			4.5	4.5
Lane Util. Factor		1.00	1.00			1.00	1.00	0.95			0.95	1.00
Frt		0.86	0.86			0.86	1.00	1.00			1.00	0.85
Flt Protected		1.00	1.00			1.00	0.95	1.00			1.00	1.00
Satd. Flow (prot)		0	1644			1644	1805	3603			3610	1615
Flt Permitted		1.00	1.00			1.00	0.95	1.00			1.00	1.00
Satd. Flow (perm)		0	1644			1644	1805	3603			3610	1615
Peak-hour factor, PHF	0.95	0.95	0.95	0.95	0.95	0.95	0.95	0.95	0.95	0.95	0.95	0.95
Adj. Flow (vph)	0	0	24	0	0	33	69	2056	25	0	1176	17
RTOR Reduction (vph)	0	2	21	0	0	32	0	0	0	0	0	4
Lane Group Flow (vph)	0	0	1	0	0	1	69	2081	0	0	1176	13
Heavy Vehicles (%)	0%	0%	0%	0%	0%	0%	0%	0%	0%	0%	0%	0%
Turn Type			Perm			Perm	Prot	NA			NA	Perm
Protected Phases	4						5	2			6	
Permitted Phases			4			8						6
Actuated Green, G (s)		0.0	3.6			3.6	8.7	107.4			94.2	94.2
Effective Green, g (s)		0.0	3.6			3.6	8.7	107.4			94.2	94.2
Actuated g/C Ratio		0.00	0.03			0.03	0.07	0.90			0.79	0.79
Clearance Time (s)			4.5			4.5	4.5	4.5			4.5	4.5
Vehicle Extension (s)			3.0			3.0	3.0	3.0			3.0	3.0
Lane Grp Cap (vph)		0	49			49	130	3224			2833	1267
v/s Ratio Prot							0.04	c0.58			0.33	
v/s Ratio Perm			0.00			c0.00						0.01
v/c Ratio		0.00	0.01			0.02	0.53	0.65			0.42	0.01
Uniform Delay, d1		60.0	56.5			56.5	53.7	1.6			4.1	2.8
Progression Factor		1.00	1.00			1.00	0.76	1.87			0.07	1.00
Incremental Delay, d2		0.0	0.1			0.2	3.0	0.7			0.4	0.0
Delay (s)		60.0	56.6			56.7	43.7	3.7			0.7	2.8
Level of Service		E	E			E	D	A			A	A
Approach Delay (s)		56.9			56.7			5.0			0.7	
Approach LOS		E			E			A			A	
Intersection Summary												
HCM 2000 Control Delay			4.3									A
HCM 2000 Volume to Capacity ratio			0.65									
Actuated Cycle Length (s)			120.0						13.5			
Intersection Capacity Utilization			66.4%									C
Analysis Period (min)			15									
c Critical Lane Group												

HCM Unsignalized Intersection Capacity Analysis
 4: US 29 & Terrace Greene Circle

07/22/2021

												
Movement	EBL	EBT	EBR	WBL	WBT	WBR	NBL	NBT	NBR	SBL	SBT	SBR
Lane Configurations												
Traffic Volume (veh/h)	0	0	0	0	0	66	0	2110	126	0	1120	0
Future Volume (Veh/h)	0	0	0	0	0	66	0	2110	126	0	1120	0
Sign Control	Stop			Stop				Free			Free	
Grade	0%			0%				0%			0%	
Peak Hour Factor	0.90	0.90	0.90	0.90	0.90	0.90	0.90	0.90	0.90	0.90	0.90	0.90
Hourly flow rate (vph)	0	0	0	0	0	73	0	2344	140	0	1244	0
Pedestrians												
Lane Width (ft)												
Walking Speed (ft/s)												
Percent Blockage												
Right turn flare (veh)												
Median type							Raised			Raised		
Median storage veh							2			2		
Upstream signal (ft)												
pX, platoon unblocked												
vC, conflicting volume	2489	3728	622	2966	3588	1172	1244			2484		
vC1, stage 1 conf vol	1244	1244		2344	2344							
vC2, stage 2 conf vol	1245	2484		622	1244							
vCu, unblocked vol	2489	3728	622	2966	3588	1172	1244			2484		
tC, single (s)	7.5	6.5	6.9	7.5	6.5	6.9	4.1			4.1		
tC, 2 stage (s)	6.5	5.5		6.5	5.5							
tF (s)	3.5	4.0	3.3	3.5	4.0	3.3	2.2			2.2		
p0 queue free %	100	100	100	100	100	61	100			100		
cM capacity (veh/h)	93	56	434	37	65	188	567			185		
Direction, Lane #	EB 1	WB 1	NB 1	NB 2	NB 3	SB 1	SB 2	SB 3	SB 4			
Volume Total	0	73	1172	1172	140	0	622	622	0			
Volume Left	0	0	0	0	0	0	0	0	0			
Volume Right	0	73	0	0	140	0	0	0	0			
cSH	1700	188	1700	1700	1700	1700	1700	1700	1700			
Volume to Capacity	0.00	0.39	0.69	0.69	0.08	0.00	0.37	0.37	0.00			
Queue Length 95th (ft)	0	42	0	0	0	0	0	0	0			
Control Delay (s)	0.0	35.7	0.0	0.0	0.0	0.0	0.0	0.0	0.0			
Lane LOS	A	E										
Approach Delay (s)	0.0	35.7	0.0			0.0						
Approach LOS	A	E										
Intersection Summary												
Average Delay			0.7									
Intersection Capacity Utilization			69.1%		ICU Level of Service				C			
Analysis Period (min)			15									

HCM Unsignalized Intersection Capacity Analysis

5: US 29 & Keleigh Lane

07/22/2021























Movement	EBL	EBR	NBL	NBT	SBT	SBR	
Lane Configurations							
Traffic Volume (veh/h)	11	10	26	1979	942	17	
Future Volume (Veh/h)	11	10	26	1979	942	17	
Sign Control	Stop			Free	Free		
Grade	0%			0%	0%		
Peak Hour Factor	0.96	0.96	0.96	0.96	0.96	0.96	
Hourly flow rate (vph)	11	10	27	2061	981	18	
Pedestrians							
Lane Width (ft)							
Walking Speed (ft/s)							
Percent Blockage							
Right turn flare (veh)							
Median type			Raised	Raised			
Median storage (veh)			2	2			
Upstream signal (ft)							
pX, platoon unblocked							
vC, conflicting volume	2066	490	999				
vC1, stage 1 conf vol	981						
vC2, stage 2 conf vol	1084						
vCu, unblocked vol	2066	490	999				
tC, single (s)	6.8	6.9	4.1				
tC, 2 stage (s)	5.8						
tF (s)	3.5	3.3	2.2				
p0 queue free %	95	98	96				
cM capacity (veh/h)	211	529	701				
Direction, Lane #	EB 1	NB 1	NB 2	NB 3	SB 1	SB 2	SB 3
Volume Total	21	27	1030	1030	490	490	18
Volume Left	11	27	0	0	0	0	0
Volume Right	10	0	0	0	0	0	18
cSH	295	701	1700	1700	1700	1700	1700
Volume to Capacity	0.07	0.04	0.61	0.61	0.29	0.29	0.01
Queue Length 95th (ft)	6	3	0	0	0	0	0
Control Delay (s)	18.1	10.3	0.0	0.0	0.0	0.0	0.0
Lane LOS	C	B					
Approach Delay (s)	18.1	0.1	0.0				
Approach LOS	C						
Intersection Summary							
Average Delay			0.2				
Intersection Capacity Utilization			64.7%	ICU Level of Service	C		
Analysis Period (min)			15				

HCM Unsignalized Intersection Capacity Analysis

6: US 29 & Commercial Entrance

07/22/2021

												
Movement	EBL	EBT	EBR	WBL	WBT	WBR	NBL	NBT	NBR	SBL	SBT	SBR
Lane Configurations												
Traffic Volume (veh/h)	0	0	0	3	0	44	11	1931	29	65	893	0
Future Volume (Veh/h)	0	0	0	3	0	44	11	1931	29	65	893	0
Sign Control		Stop			Stop			Free			Free	
Grade		0%			0%			0%			0%	
Peak Hour Factor	0.97	0.97	0.97	0.97	0.97	0.97	0.97	0.97	0.97	0.97	0.97	0.97
Hourly flow rate (vph)	0	0	0	3	0	45	11	1991	30	67	921	0
Pedestrians												
Lane Width (ft)												
Walking Speed (ft/s)												
Percent Blockage												
Right turn flare (veh)												
Median type												
Median storage veh												
Upstream signal (ft)												
pX, platoon unblocked												
vC, conflicting volume	2072	3098	460	2608	3068	996	921			2021		
vC1, stage 1 conf vol	1055	1055		2013	2013							
vC2, stage 2 conf vol	1018	2043		594	1055							
vCu, unblocked vol	2072	3098	460	2608	3068	996	921			2021		
tC, single (s)	7.5	6.5	6.9	7.5	6.5	6.9	4.1			4.1		
tC, 2 stage (s)	6.5	5.5		6.5	5.5							
tF (s)	3.5	4.0	3.3	3.5	4.0	3.3	2.2			2.2		
p0 queue free %	100	100	100	95	100	82	99			76		
cM capacity (veh/h)	110	31	553	59	89	247	750			278		
Direction, Lane #	EB 1	WB 1	NB 1	NB 2	NB 3	NB 4	SB 1	SB 2	SB 3			
Volume Total	0	48	11	996	996	30	67	460	460			
Volume Left	0	3	11	0	0	0	67	0	0			
Volume Right	0	45	0	0	0	30	0	0	0			
cSH	1700	263	750	1700	1700	1700	278	1700	1700			
Volume to Capacity	0.00	0.18	0.01	0.59	0.59	0.02	0.24	0.27	0.27			
Queue Length 95th (ft)	0	16	1	0	0	0	23	0	0			
Control Delay (s)	0.0	25.8	9.9	0.0	0.0	0.0	22.0	0.0	0.0			
Lane LOS	A	D	A				C					
Approach Delay (s)	0.0	25.8	0.1				1.5					
Approach LOS	A	D										
Intersection Summary												
Average Delay			0.9									
Intersection Capacity Utilization			64.0%		ICU Level of Service				C			
Analysis Period (min)			15									

HCM Unsignalized Intersection Capacity Analysis

7: US 29 & Lake Saponi Drive

07/22/2021



Movement	WBL	WBR	NBT	NBR	SBL	SBT
Lane Configurations		↗	↕	↗		↕
Traffic Volume (veh/h)	0	42	2227	56	0	1052
Future Volume (Veh/h)	0	42	2227	56	0	1052
Sign Control	Stop		Free			Free
Grade	0%		0%			0%
Peak Hour Factor	0.95	0.95	0.95	0.95	0.95	0.95
Hourly flow rate (vph)	0	44	2344	59	0	1107
Pedestrians						
Lane Width (ft)						
Walking Speed (ft/s)						
Percent Blockage						
Right turn flare (veh)						
Median type			Raised			Raised
Median storage (veh)			2			2
Upstream signal (ft)						
pX, platoon unblocked						
vC, conflicting volume	2898	1172			2403	
vC1, stage 1 conf vol	2344					
vC2, stage 2 conf vol	554					
vCu, unblocked vol	2898	1172			2403	
tC, single (s)	6.8	6.9			4.1	
tC, 2 stage (s)	5.8					
tF (s)	3.5	3.3			2.2	
p0 queue free %	100	77			100	
cM capacity (veh/h)	58	188			202	
Direction, Lane #	WB 1	NB 1	NB 2	NB 3	SB 1	SB 2
Volume Total	44	1172	1172	59	554	554
Volume Left	0	0	0	0	0	0
Volume Right	44	0	0	59	0	0
cSH	188	1700	1700	1700	1700	1700
Volume to Capacity	0.23	0.69	0.69	0.03	0.33	0.33
Queue Length 95th (ft)	22	0	0	0	0	0
Control Delay (s)	29.9	0.0	0.0	0.0	0.0	0.0
Lane LOS	D					
Approach Delay (s)	29.9	0.0			0.0	
Approach LOS	D					
Intersection Summary						
Average Delay			0.4			
Intersection Capacity Utilization			71.6%		ICU Level of Service	C
Analysis Period (min)			15			

HCM Unsignalized Intersection Capacity Analysis

8: US 29 & Greene Edge Lane

08/10/2021



Movement	EBL	EBT	EBR	WBL	WBT	WBR	NBL	NBT	NBR	SBL	SBT	SBR
Lane Configurations	↗							↖↗			↖↗	
Traffic Volume (veh/h)	0	0	0	0	0	0	1	2289	0	16	1027	1
Future Volume (Veh/h)	0	0	0	0	0	0	1	2289	0	16	1027	1
Sign Control		Stop			Stop			Free			Free	
Grade		0%			0%			0%			0%	
Peak Hour Factor	0.97	0.92	0.97	0.92	0.92	0.92	0.97	0.97	0.92	0.92	0.97	0.97
Hourly flow rate (vph)	0	0	0	0	0	0	1	2360	0	17	1059	1
Pedestrians												
Lane Width (ft)												
Walking Speed (ft/s)												
Percent Blockage												
Right turn flare (veh)												
Median type												
Median storage (veh)												
Upstream signal (ft)												
pX, platoon unblocked												
vC, conflicting volume	2276	3456	530	2926	3456	1180	1060			2360		
vC1, stage 1 conf vol	1094	1094		2362	2362							
vC2, stage 2 conf vol	1182	2362		564	1094							
vCu, unblocked vol	2276	3456	530	2926	3456	1180	1060			2360		
tC, single (s)	7.5	6.5	6.9	7.5	6.5	6.9	4.1			4.1		
tC, 2 stage (s)	6.5	5.5		6.5	5.5							
tF (s)	3.5	4.0	3.3	3.5	4.0	3.3	2.2			2.2		
p0 queue free %	100	100	100	100	100	100	100			92		
cM capacity (veh/h)	136	48	499	35	63	183	665			204		
Direction, Lane #												
	EB 1	NB 1	NB 2	SB 1	SB 2							
Volume Total	0	788	1573	546	530							
Volume Left	0	1	0	17	0							
Volume Right	0	0	0	0	1							
cSH	1700	665	1700	204	1700							
Volume to Capacity	0.00	0.00	0.93	0.08	0.31							
Queue Length 95th (ft)	0	0	0	7	0							
Control Delay (s)	0.0	0.0	0.0	3.6	0.0							
Lane LOS	A	A		A								
Approach Delay (s)	0.0	0.0		1.8								
Approach LOS	A											
Intersection Summary												
Average Delay			0.6									
Intersection Capacity Utilization			67.3%	ICU Level of Service	C							
Analysis Period (min)			15									

Queues

9: US 29 & Frays Mill Road

07/22/2021



Lane Group	EBT	WBT	NBL	NBT	NBR	SBL	SBT	SBR
Lane Group Flow (vph)	75	139	144	2337	128	42	1082	9
v/c Ratio	0.47	0.99	0.67	1.07	0.13	0.35	0.58	0.01
Control Delay	38.9	108.1	48.9	68.6	4.4	50.9	34.8	0.0
Queue Delay	0.0	0.0	0.0	0.0	0.0	0.0	0.0	0.0
Total Delay	38.9	108.1	48.9	68.6	4.4	50.9	34.8	0.0
Queue Length 50th (ft)	27	67	102	~1125	12	32	381	0
Queue Length 95th (ft)	77	#203	m122	#1267	m16	71	475	m0
Internal Link Dist (ft)	1259	1300		5774			2511	
Turn Bay Length (ft)			350		350	375		375
Base Capacity (vph)	158	140	253	2182	1000	120	1871	909
Starvation Cap Reductn	0	0	0	0	0	0	0	0
Spillback Cap Reductn	0	0	0	0	0	0	0	0
Storage Cap Reductn	0	0	0	0	0	0	0	0
Reduced v/c Ratio	0.47	0.99	0.57	1.07	0.13	0.35	0.58	0.01

Intersection Summary

- ~ Volume exceeds capacity, queue is theoretically infinite.
Queue shown is maximum after two cycles.
- # 95th percentile volume exceeds capacity, queue may be longer.
Queue shown is maximum after two cycles.
- m Volume for 95th percentile queue is metered by upstream signal.

HCM Signalized Intersection Capacity Analysis

9: US 29 & Frays Mill Road

07/22/2021



Movement	EBL	EBT	EBR	WBL	WBT	WBR	NBL	NBT	NBR	SBL	SBT	SBR
Lane Configurations		↔			↔		↗	↕	↗	↗	↕	↗
Traffic Volume (vph)	21	13	40	40	11	85	141	2290	125	41	1060	9
Future Volume (vph)	21	13	40	40	11	85	141	2290	125	41	1060	9
Ideal Flow (vphpl)	1900	1900	1900	1900	1900	1900	1900	1900	1900	1900	1900	1900
Total Lost time (s)		6.0			6.0		6.0	6.0	6.0	6.0	6.0	6.0
Lane Util. Factor		1.00			1.00		1.00	0.95	1.00	1.00	0.95	1.00
Frt		0.93			0.92		1.00	1.00	0.85	1.00	1.00	0.85
Flt Protected		0.99			0.99		0.95	1.00	1.00	0.95	1.00	1.00
Satd. Flow (prot)		1689			1652		1787	3539	1538	1805	3471	1524
Flt Permitted		0.86			0.64		0.95	1.00	1.00	0.95	1.00	1.00
Satd. Flow (perm)		1469			1078		1787	3539	1538	1805	3471	1524
Peak-hour factor, PHF	0.98	0.98	0.98	0.98	0.98	0.98	0.98	0.98	0.98	0.98	0.98	0.98
Adj. Flow (vph)	21	13	41	41	11	87	144	2337	128	42	1082	9
RTOR Reduction (vph)	0	36	0	0	50	0	0	0	52	0	0	4
Lane Group Flow (vph)	0	39	0	0	89	0	144	2337	76	42	1082	5
Heavy Vehicles (%)	0%	0%	5%	0%	0%	6%	1%	2%	5%	0%	4%	6%
Turn Type	Perm	NA		Perm	NA		Prot	NA	Prot	Prot	NA	Prot
Protected Phases		4			3		5	2	2	1	6	6
Permitted Phases	4			3								
Actuated Green, G (s)		8.0			10.0		14.5	71.6	71.6	6.4	63.5	63.5
Effective Green, g (s)		8.0			10.0		14.5	71.6	71.6	6.4	63.5	63.5
Actuated g/C Ratio		0.07			0.08		0.12	0.60	0.60	0.05	0.53	0.53
Clearance Time (s)		6.0			6.0		6.0	6.0	6.0	6.0	6.0	6.0
Vehicle Extension (s)		4.0			4.0		3.5	6.0	6.0	3.5	6.0	6.0
Lane Grp Cap (vph)		97			89		215	2111	917	96	1836	806
v/s Ratio Prot							c0.08	c0.66	0.05	0.02	0.31	0.00
v/s Ratio Perm		c0.03			c0.08							
v/c Ratio		0.40			1.00		0.67	1.11	0.08	0.44	0.59	0.01
Uniform Delay, d1		53.7			55.0		50.5	24.2	10.3	55.1	19.3	13.3
Progression Factor		1.00			1.00		0.81	1.34	2.40	0.80	1.66	1.00
Incremental Delay, d2		3.6			93.5		4.2	52.3	0.1	3.7	1.4	0.0
Delay (s)		57.3			148.4		45.1	84.6	24.7	47.5	33.5	13.4
Level of Service		E			F		D	F	C	D	C	B
Approach Delay (s)		57.3			148.4			79.5			33.9	
Approach LOS		E			F			E			C	



















Intersection Summary

HCM 2000 Control Delay	68.5	HCM 2000 Level of Service	E
HCM 2000 Volume to Capacity ratio	1.03		
Actuated Cycle Length (s)	120.0	Sum of lost time (s)	24.0
Intersection Capacity Utilization	95.7%	ICU Level of Service	F
Analysis Period (min)	15		
c Critical Lane Group			

HCM Unsignalized Intersection Capacity Analysis

10: US 29 & Dickerson Road

07/22/2021

												
Movement	EBL	EBT	EBR	WBL	WBT	WBR	NBL	NBT	NBR	SBL	SBT	SBR
Lane Configurations												
Traffic Volume (veh/h)	27	0	13	0	0	0	40	2487	2	1	1092	16
Future Volume (Veh/h)	27	0	13	0	0	0	40	2487	2	1	1092	16
Sign Control		Stop			Stop			Free			Free	
Grade		0%			0%			0%			0%	
Peak Hour Factor	0.96	0.96	0.96	0.96	0.96	0.96	0.96	0.96	0.96	0.96	0.96	0.96
Hourly flow rate (vph)	28	0	14	0	0	0	42	2591	2	1	1138	17
Pedestrians												
Lane Width (ft)												
Walking Speed (ft/s)												
Percent Blockage												
Right turn flare (veh)												
Median type												
Median storage (veh)												
Upstream signal (ft)												
pX, platoon unblocked												
vC, conflicting volume	2520	3817	569	3261	3833	1296	1155			2593		
vC1, stage 1 conf vol	1140	1140		2676	2676							
vC2, stage 2 conf vol	1380	2677		585	1157							
vCu, unblocked vol	2520	3817	569	3261	3833	1296	1155			2593		
tC, single (s)	7.7	6.5	6.9	7.5	6.5	6.9	4.2			4.1		
tC, 2 stage (s)	6.7	5.5		6.5	5.5							
tF (s)	3.6	4.0	3.3	3.5	4.0	3.3	2.3			2.2		
p0 queue free %	73	100	97	100	100	100	93			99		
cM capacity (veh/h)	105	41	470	21	42	155	578			170		
Direction, Lane #	EB 1	WB 1	NB 1	NB 2	NB 3	SB 1	SB 2	SB 3	SB 4			
Volume Total	42	0	42	1727	866	1	569	569	17			
Volume Left	28	0	42	0	0	1	0	0	0			
Volume Right	14	0	0	0	2	0	0	0	17			
cSH	142	1700	578	1700	1700	170	1700	1700	1700			
Volume to Capacity	0.30	0.00	0.07	1.02	0.51	0.01	0.33	0.33	0.01			
Queue Length 95th (ft)	29	0	6	0	0	0	0	0	0			
Control Delay (s)	40.6	0.0	11.7	0.0	0.0	26.3	0.0	0.0	0.0			
Lane LOS	E	A	B			D						
Approach Delay (s)	40.6	0.0	0.2			0.0						
Approach LOS	E	A										
Intersection Summary												
Average Delay			0.6									
Intersection Capacity Utilization			78.8%		ICU Level of Service					D		
Analysis Period (min)			15									

Queues

11: US 29 & Austin Drive

07/22/2021



Lane Group	EBL	EBT	NBL	NBT	SBT	SBR
Lane Group Flow (vph)	13	42	31	2606	1134	25
v/c Ratio	0.12	0.13	0.27	0.86	0.42	0.02
Control Delay	55.9	0.8	49.3	10.5	8.0	0.0
Queue Delay	0.0	0.0	0.0	0.0	0.0	0.0
Total Delay	55.9	0.8	49.3	10.5	8.0	0.0
Queue Length 50th (ft)	10	0	25	261	120	0
Queue Length 95th (ft)	31	0	m29	m457	m234	m0
Internal Link Dist (ft)		306		2056	2636	
Turn Bay Length (ft)			500			350
Base Capacity (vph)	108	328	113	3026	2710	1174
Starvation Cap Reductn	0	0	0	0	0	0
Spillback Cap Reductn	0	0	0	0	0	0
Storage Cap Reductn	0	0	0	0	0	0
Reduced v/c Ratio	0.12	0.13	0.27	0.86	0.42	0.02





















Intersection Summary

m Volume for 95th percentile queue is metered by upstream signal.

HCM Signalized Intersection Capacity Analysis

11: US 29 & Austin Drive

07/22/2021

												
Movement	EBL	EBT	EBR	WBL	WBT	WBR	NBL	NBT	NBR	SBL	SBT	SBR
Lane Configurations												
Traffic Volume (vph)	12	0	40	0	0	0	30	2502	0	0	1089	24
Future Volume (vph)	12	0	40	0	0	0	30	2502	0	0	1089	24
Ideal Flow (vphpl)	1900	1900	1900	1900	1900	1900	1900	1900	1900	1900	1900	1900
Total Lost time (s)	7.5	7.5					7.5	7.0			7.0	7.0
Lane Util. Factor	1.00	1.00					1.00	0.95			0.95	1.00
Frt	1.00	0.85					1.00	1.00			1.00	0.85
Flt Protected	0.95	1.00					0.95	1.00			1.00	1.00
Satd. Flow (prot)	1805	1568					1671	3539			3505	1468
Flt Permitted	0.95	1.00					0.95	1.00			1.00	1.00
Satd. Flow (perm)	1805	1568					1671	3539			3505	1468
Peak-hour factor, PHF	0.96	0.96	0.96	0.96	0.96	0.96	0.96	0.96	0.96	0.96	0.96	0.96
Adj. Flow (vph)	12	0	42	0	0	0	31	2606	0	0	1134	25
RTOR Reduction (vph)	0	40	0	0	0	0	0	0	0	0	0	7
Lane Group Flow (vph)	13	2	0	0	0	0	31	2606	0	0	1134	18
Heavy Vehicles (%)	0%	0%	3%	0%	0%	0%	8%	2%	0%	0%	3%	10%
Turn Type	Split	NA					Prot	NA			NA	Prot
Protected Phases	4	4			3		5	2			6	6
Permitted Phases				3						6		
Actuated Green, G (s)	5.8	5.8					5.3	99.7			86.9	86.9
Effective Green, g (s)	5.8	5.8					5.3	99.7			86.9	86.9
Actuated g/C Ratio	0.05	0.05					0.04	0.83			0.72	0.72
Clearance Time (s)	7.5	7.5					7.5	7.0			7.0	7.0
Vehicle Extension (s)	3.0	3.0					3.0	3.0			3.0	3.0
Lane Grp Cap (vph)	87	75					73	2940			2538	1063
v/s Ratio Prot	c0.01	0.00					0.02	c0.74			0.32	0.01
v/s Ratio Perm												
v/c Ratio	0.15	0.03					0.42	0.89			0.45	0.02
Uniform Delay, d1	54.7	54.4					55.9	6.5			6.7	4.6
Progression Factor	1.00	1.00					0.89	1.25			1.11	1.00
Incremental Delay, d2	0.8	0.1					1.5	1.8			0.5	0.0
Delay (s)	55.5	54.6					51.1	9.9			8.0	4.6
Level of Service	E	D					D	A			A	A
Approach Delay (s)		54.8			0.0			10.4			7.9	
Approach LOS		D			A			B			A	
Intersection Summary												
HCM 2000 Control Delay			10.3				HCM 2000 Level of Service				B	
HCM 2000 Volume to Capacity ratio			0.98									
Actuated Cycle Length (s)			120.0				Sum of lost time (s)			29.0		
Intersection Capacity Utilization			97.5%				ICU Level of Service			F		
Analysis Period (min)			15									
c Critical Lane Group												

Queues

12: US 29 & Boulders Road

07/22/2021

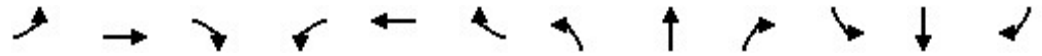

Lane Group	EBL	EBT	EBR	WBL	WBT	WBR	NBL	NBT	NBR	SBL	SBT	SBR
Lane Group Flow (vph)	21	27	93	91	92	97	139	2421	15	6	1115	38
v/c Ratio	0.22	0.14	0.33	0.91	0.92	0.34	0.67	0.99	0.01	0.03	0.58	0.04
Control Delay	59.8	55.4	3.2	124.6	126.9	3.2	65.9	33.6	0.0	39.3	31.5	0.1
Queue Delay	0.0	0.0	0.0	0.0	0.0	0.0	0.0	0.0	0.0	0.0	0.0	0.0
Total Delay	59.8	55.4	3.2	124.6	126.9	3.2	65.9	33.6	0.0	39.3	31.5	0.1
Queue Length 50th (ft)	17	10	0	75	75	0	104	786	0	2	469	0
Queue Length 95th (ft)	47	28	0	#185	#186	0	169	#1278	0	m6	484	0
Internal Link Dist (ft)		179			369			1679			2056	
Turn Bay Length (ft)			175			350	400		300	550		425
Base Capacity (vph)	95	193	279	100	100	286	259	2457	1168	204	1928	957
Starvation Cap Reductn	0	0	0	0	0	0	0	0	0	0	0	0
Spillback Cap Reductn	0	0	0	0	0	0	0	0	0	0	0	0
Storage Cap Reductn	0	0	0	0	0	0	0	0	0	0	0	0
Reduced v/c Ratio	0.22	0.14	0.33	0.91	0.92	0.34	0.54	0.99	0.01	0.03	0.58	0.04

Intersection Summary

95th percentile volume exceeds capacity, queue may be longer.

Queue shown is maximum after two cycles.

m Volume for 95th percentile queue is metered by upstream signal.

HCM Signalized Intersection Capacity Analysis

12: US 29 & Boulders Road

07/22/2021























Movement	EBL	EBT	EBR	WBL	WBT	WBR	NBL	NBT	NBR	SBL	SBT	SBR
Lane Configurations												
Traffic Volume (vph)	43	5	92	167	14	96	138	2397	15	6	1104	38
Future Volume (vph)	43	5	92	167	14	96	138	2397	15	6	1104	38
Ideal Flow (vphpl)	1900	1900	1900	1900	1900	1900	1900	1900	1900	1900	1900	1900
Total Lost time (s)	6.9	6.9	6.9	6.9	6.9	6.9	5.9	6.2	6.2	6.4	6.0	6.0
Lane Util. Factor	0.91	0.91	1.00	0.95	0.95	1.00	1.00	0.95	1.00	0.97	0.95	1.00
Frt	1.00	1.00	0.85	1.00	1.00	0.85	1.00	1.00	0.85	1.00	1.00	0.85
Flt Protected	0.95	0.96	1.00	0.95	0.96	1.00	0.95	1.00	1.00	0.95	1.00	1.00
Satd. Flow (prot)	1643	3323	1495	1715	1732	1615	1752	3539	1615	3502	3505	1568
Flt Permitted	0.95	0.96	1.00	0.95	0.96	1.00	0.95	1.00	1.00	0.95	1.00	1.00
Satd. Flow (perm)	1643	3323	1495	1715	1732	1615	1752	3539	1615	3502	3505	1568
Peak-hour factor, PHF	0.99	0.99	0.99	0.99	0.99	0.99	0.99	0.99	0.99	0.99	0.99	0.99
Adj. Flow (vph)	43	5	93	169	14	97	139	2421	15	6	1115	38
RTOR Reduction (vph)	0	0	88	0	0	91	0	0	5	0	0	17
Lane Group Flow (vph)	21	27	5	91	92	6	139	2421	10	6	1115	21
Heavy Vehicles (%)	0%	0%	8%	0%	0%	0%	3%	2%	0%	0%	3%	3%
Turn Type	Split	NA	Prot	Split	NA	Prot	Prot	NA	Prot	Prot	NA	Prot
Protected Phases	4	4	4	3	3	3	5	2	2	1	6	6
Permitted Phases												
Actuated Green, G (s)	7.0	7.0	7.0	7.0	7.0	7.0	14.3	78.2	78.2	1.4	66.0	66.0
Effective Green, g (s)	7.0	7.0	7.0	7.0	7.0	7.0	14.3	78.2	78.2	1.4	66.0	66.0
Actuated g/C Ratio	0.06	0.06	0.06	0.06	0.06	0.06	0.12	0.65	0.65	0.01	0.55	0.55
Clearance Time (s)	6.9	6.9	6.9	6.9	6.9	6.9	5.9	6.2	6.2	6.4	6.0	6.0
Vehicle Extension (s)	3.0	3.0	3.0	3.0	3.0	3.0	3.0	3.0	3.0	3.0	3.0	3.0
Lane Grp Cap (vph)	95	193	87	100	101	94	208	2306	1052	40	1927	862
v/s Ratio Prot	c0.01	0.01	0.00	0.05	c0.05	0.00	c0.08	c0.68	0.01	0.00	0.32	0.01
v/s Ratio Perm												
v/c Ratio	0.22	0.14	0.06	0.91	0.91	0.06	0.67	1.05	0.01	0.15	0.58	0.02
Uniform Delay, d1	53.9	53.6	53.4	56.2	56.2	53.4	50.6	20.9	7.3	58.7	17.8	12.3
Progression Factor	1.00	1.00	1.00	1.00	1.00	1.00	1.00	1.00	1.00	0.73	1.64	1.00
Incremental Delay, d2	1.2	0.3	0.3	61.7	61.5	0.3	7.9	33.5	0.0	1.6	1.2	0.0
Delay (s)	55.1	54.0	53.7	117.9	117.7	53.7	58.5	54.4	7.3	44.5	30.4	12.4
Level of Service	E	D	D	F	F	D	E	D	A	D	C	B
Approach Delay (s)		54.0			95.6			54.3			29.9	
Approach LOS		D			F			D			C	
Intersection Summary												
HCM 2000 Control Delay			50.3				HCM 2000 Level of Service				D	
HCM 2000 Volume to Capacity ratio			1.00									
Actuated Cycle Length (s)			120.0				Sum of lost time (s)			26.4		
Intersection Capacity Utilization			100.0%				ICU Level of Service			G		
Analysis Period (min)			15									
c Critical Lane Group												

HCM Unsignalized Intersection Capacity Analysis

13: US 29 & Camelot Drive

07/22/2021

													
Movement	EBL	EBT	EBR	WBL	WBT	WBR	NBL	NBT	NBR	SBL	SBT	SBR	
Lane Configurations													
Traffic Volume (veh/h)	3	0	37	12	0	16	87	2522	5	1	1369	7	
Future Volume (Veh/h)	3	0	37	12	0	16	87	2522	5	1	1369	7	
Sign Control		Stop			Stop			Free			Free		
Grade		0%			0%			0%			0%		
Peak Hour Factor	0.93	0.93	0.93	0.93	0.93	0.93	0.93	0.93	0.93	0.93	0.93	0.93	
Hourly flow rate (vph)	3	0	40	13	0	17	94	2712	5	1	1472	8	
Pedestrians													
Lane Width (ft)													
Walking Speed (ft/s)													
Percent Blockage													
Right turn flare (veh)													
Median type													
Median storage veh													
Upstream signal (ft)													
pX, platoon unblocked													
vC, conflicting volume	3035	4379	736	3678	4382	1356	1480			2717			
vC1, stage 1 conf vol	1474	1474		2900	2900								
vC2, stage 2 conf vol	1561	2905		778	1482								
vCu, unblocked vol	3035	4379	736	3678	4382	1356	1480			2717			
tC, single (s)	7.5	6.5	7.0	7.5	6.5	7.2	4.1			4.1			
tC, 2 stage (s)	6.5	5.5		6.5	5.5								
tF (s)	3.5	4.0	3.3	3.5	4.0	3.4	2.2			2.2			
p0 queue free %	95	100	89	0	100	86	79			99			
cM capacity (veh/h)	66	26	359	13	26	125	456			152			
Direction, Lane #	EB 1	WB 1	NB 1	NB 2	NB 3	NB 4	SB 1	SB 2	SB 3	SB 4			
Volume Total	43	30	94	1356	1356	5	1	736	736	8			
Volume Left	3	13	94	0	0	0	1	0	0	0			
Volume Right	40	17	0	0	0	5	0	0	0	8			
cSH	274	26	456	1700	1700	1700	152	1700	1700	1700			
Volume to Capacity	0.16	1.16	0.21	0.80	0.80	0.00	0.01	0.43	0.43	0.00			
Queue Length 95th (ft)	14	91	19	0	0	0	0	0	0	0			
Control Delay (s)	20.6	452.7	14.9	0.0	0.0	0.0	28.8	0.0	0.0	0.0			
Lane LOS	C	F	B				D						
Approach Delay (s)	20.6	452.7	0.5				0.0						
Approach LOS	C	F											
Intersection Summary													
Average Delay			3.6										
Intersection Capacity Utilization			84.4%	ICU Level of Service					E				
Analysis Period (min)			15										

HCM Unsignalized Intersection Capacity Analysis
 18: US 29 & Airport Acres Rd South

07/22/2021



Movement	EBL	EBR	NBL	NBT	SBT	SBR
Lane Configurations						
Traffic Volume (veh/h)	1	9	23	2570	1587	0
Future Volume (Veh/h)	1	9	23	2570	1587	0
Sign Control	Stop			Free	Free	
Grade	0%			0%	0%	
Peak Hour Factor	0.97	0.97	0.97	0.97	0.97	0.97
Hourly flow rate (vph)	1	9	24	2649	1636	0
Pedestrians						
Lane Width (ft)						
Walking Speed (ft/s)						
Percent Blockage						
Right turn flare (veh)						
Median type				Raised	Raised	
Median storage (veh)				2	2	
Upstream signal (ft)				872		
pX, platoon unblocked	0.45					
vC, conflicting volume	3008	818	1636			
vC1, stage 1 conf vol	1636					
vC2, stage 2 conf vol	1372					
vCu, unblocked vol	3019	818	1636			
tC, single (s)	6.8	7.1	4.1			
tC, 2 stage (s)	5.8					
tF (s)	3.5	3.4	2.2			
p0 queue free %	99	97	94			
cM capacity (veh/h)	133	303	402			
Direction, Lane #	EB 1	NB 1	NB 2	NB 3	SB 1	SB 2
Volume Total	10	24	1324	1324	818	818
Volume Left	1	24	0	0	0	0
Volume Right	9	0	0	0	0	0
cSH	269	402	1700	1700	1700	1700
Volume to Capacity	0.04	0.06	0.78	0.78	0.48	0.48
Queue Length 95th (ft)	3	5	0	0	0	0
Control Delay (s)	18.9	14.5	0.0	0.0	0.0	0.0
Lane LOS	C	B				
Approach Delay (s)	18.9	0.1	0.0			
Approach LOS	C					
Intersection Summary						
Average Delay	0.1					
Intersection Capacity Utilization	81.0%			ICU Level of Service	D	
Analysis Period (min)	15					

Queues

19: US 29 & Airport Road

07/22/2021



Lane Group	EBL	EBT	EBR	WBL	WBT	NBL	NBT	NBR	SBL	SBT	SBR
Lane Group Flow (vph)	150	106	198	144	261	119	2558	207	198	1383	109
v/c Ratio	1.03	1.04	0.33	1.22	1.37	0.53	1.31	0.18	1.26	0.69	0.10
Control Delay	143.7	158.6	21.6	203.0	228.2	67.7	172.0	3.8	205.4	21.3	1.3
Queue Delay	0.0	0.0	0.0	0.0	0.0	0.0	0.0	0.0	0.0	0.0	0.0
Total Delay	143.7	158.6	21.6	203.0	228.2	67.7	172.0	3.8	205.4	21.3	1.3
Queue Length 50th (ft)	~69	~96	35	~148	~241	51	~1458	27	~209	411	0
Queue Length 95th (ft)	#142	#218	74	#286	#418	84	#1586	53	#366	492	17
Internal Link Dist (ft)		677			627		911			792	
Turn Bay Length (ft)	425		450	570		575		430	475		540
Base Capacity (vph)	145	102	615	118	191	235	1949	1120	157	2016	1104
Starvation Cap Reductn	0	0	0	0	0	0	0	0	0	0	0
Spillback Cap Reductn	0	0	0	0	0	0	0	0	0	0	0
Storage Cap Reductn	0	0	0	0	0	0	0	0	0	0	0
Reduced v/c Ratio	1.03	1.04	0.32	1.22	1.37	0.51	1.31	0.18	1.26	0.69	0.10

Intersection Summary

~ Volume exceeds capacity, queue is theoretically infinite.

Queue shown is maximum after two cycles.





























95th percentile volume exceeds capacity, queue may be longer.

Queue shown is maximum after two cycles.

HCM Signalized Intersection Capacity Analysis

19: US 29 & Airport Road

07/22/2021

												
Movement	EBL	EBT	EBR	WBL	WBT	WBR	NBL	NBT	NBR	SBL	SBT	SBR
Lane Configurations	 		 				 	 			 	
Traffic Volume (vph)	144	102	190	138	83	168	114	2456	199	190	1328	105
Future Volume (vph)	144	102	190	138	83	168	114	2456	199	190	1328	105
Ideal Flow (vphpl)	1900	1900	1900	1900	1900	1900	1900	1900	1900	1900	1900	1900
Total Lost time (s)	10.5	6.7	6.7	9.1	5.6		8.3	5.7	5.7	8.1	5.7	5.7
Lane Util. Factor	0.97	1.00	0.88	1.00	1.00		0.97	0.95	1.00	1.00	0.95	1.00
Frt	1.00	1.00	0.85	1.00	0.90		1.00	1.00	0.85	1.00	1.00	0.85
Flt Protected	0.95	1.00	1.00	0.95	1.00		0.95	1.00	1.00	0.95	1.00	1.00
Satd. Flow (prot)	3433	1827	2787	1736	1692		3433	3505	1568	1719	3471	1524
Flt Permitted	0.95	1.00	1.00	0.95	1.00		0.95	1.00	1.00	0.95	1.00	1.00
Satd. Flow (perm)	3433	1827	2787	1736	1692		3433	3505	1568	1719	3471	1524
Peak-hour factor, PHF	0.96	0.96	0.96	0.96	0.96	0.96	0.96	0.96	0.96	0.96	0.96	0.96
Adj. Flow (vph)	150	106	198	144	86	175	119	2558	207	198	1383	109
RTOR Reduction (vph)	0	0	92	0	56	0	0	0	33	0	0	36
Lane Group Flow (vph)	150	106	106	144	205	0	119	2558	174	198	1383	73
Heavy Vehicles (%)	2%	4%	2%	4%	3%	0%	2%	3%	3%	5%	4%	6%
Turn Type	Prot	NA	pt+ov	Prot	NA		Prot	NA	pt+ov	Prot	NA	pt+ov
Protected Phases	7	4	4 5	3	8		5	2	2 3	1	6	6 7
Permitted Phases												
Actuated Green, G (s)	5.5	7.3	22.5	8.9	10.4		8.5	72.3	86.9	11.9	75.5	86.7
Effective Green, g (s)	5.5	7.3	22.5	8.9	10.4		8.5	72.3	86.9	11.9	75.5	86.7
Actuated g/C Ratio	0.04	0.06	0.17	0.07	0.08		0.07	0.56	0.67	0.09	0.58	0.67
Clearance Time (s)	10.5	6.7		9.1	5.6		8.3	5.7		8.1	5.7	
Vehicle Extension (s)	3.0	3.0		3.0	3.0		3.0	3.0		3.0	3.0	
Lane Grp Cap (vph)	145	102	482	118	135		224	1949	1048	157	2015	1016
v/s Ratio Prot	0.04	0.06	0.04	c0.08	c0.12		0.03	c0.73	0.11	c0.12	c0.40	0.05
v/s Ratio Perm												
v/c Ratio	1.03	1.04	0.22	1.22	1.52		0.53	1.31	0.17	1.26	0.69	0.07
Uniform Delay, d1	62.2	61.4	46.2	60.5	59.8		58.8	28.9	8.0	59.0	19.0	7.6
Progression Factor	1.00	1.00	1.00	1.00	1.00		1.00	1.00	1.00	1.00	1.00	1.00
Incremental Delay, d2	84.2	100.1	0.2	153.7	267.0		2.4	144.4	0.1	158.6	1.9	0.0
Delay (s)	146.4	161.4	46.4	214.2	326.8		61.2	173.2	8.1	217.6	20.9	7.6
Level of Service	F	F	D	F	F		E	F	A	F	C	A
Approach Delay (s)		106.3			286.8			156.8			43.1	
Approach LOS		F			F			F			D	
Intersection Summary												
HCM 2000 Control Delay			126.9			HCM 2000 Level of Service			F			
HCM 2000 Volume to Capacity ratio			1.37									
Actuated Cycle Length (s)			130.0			Sum of lost time (s)		30.1				
Intersection Capacity Utilization			120.2%			ICU Level of Service			H			
Analysis Period (min)			15									
c Critical Lane Group												

Queues

140: US 29 (S) & Lewis and Clark U-Turn N

07/22/2021



Lane Group	WBL	SBT
Lane Group Flow (vph)	30	1609
v/c Ratio	0.21	0.50
Control Delay	4.6	1.7
Queue Delay	0.0	0.0
Total Delay	4.6	1.7
Queue Length 50th (ft)	0	93
Queue Length 95th (ft)	m0	115
Internal Link Dist (ft)	23	492
Turn Bay Length (ft)		
Base Capacity (vph)	342	3218
Starvation Cap Reductn	0	0
Spillback Cap Reductn	0	0
Storage Cap Reductn	0	0
Reduced v/c Ratio	0.09	0.50

Intersection Summary

m Volume for 95th percentile queue is metered by upstream signal.

HCM Signalized Intersection Capacity Analysis
 140: US 29 (S) & Lewis and Clark U-Turn N

07/22/2021



Movement	WBL	WBR	NBT	NBR	SBL	SBT
Lane Configurations	↶					↷↷
Traffic Volume (vph)	28	0	0	0	0	1480
Future Volume (vph)	28	0	0	0	0	1480
Ideal Flow (vphpl)	1900	1900	1900	1900	1900	1900
Total Lost time (s)	4.5					4.5
Lane Util. Factor	1.00					0.95
Frt	1.00					1.00
Flt Protected	0.95					1.00
Satd. Flow (prot)	1770					3471
Flt Permitted	0.95					1.00
Satd. Flow (perm)	1770					3471
Peak-hour factor, PHF	0.92	0.92	0.92	0.92	0.92	0.92
Adj. Flow (vph)	30	0	0	0	0	1609
RTOR Reduction (vph)	29	0	0	0	0	0
Lane Group Flow (vph)	1	0	0	0	0	1609
Heavy Vehicles (%)	2%	2%	2%	2%	0%	4%
Turn Type	Prot					NA
Protected Phases	8					6
Permitted Phases						
Actuated Green, G (s)	3.3					107.7
Effective Green, g (s)	3.3					107.7
Actuated g/C Ratio	0.03					0.90
Clearance Time (s)	4.5					4.5
Vehicle Extension (s)	3.0					3.0
Lane Grp Cap (vph)	48					3115
v/s Ratio Prot	c0.00					c0.46
v/s Ratio Perm						
v/c Ratio	0.02					0.52
Uniform Delay, d1	56.8					1.2
Progression Factor	2.97					1.00
Incremental Delay, d2	0.1					0.6
Delay (s)	168.7					1.8
Level of Service	F					A
Approach Delay (s)	168.7		0.0			1.8
Approach LOS	F		A			A
Intersection Summary						
HCM 2000 Control Delay			4.8		HCM 2000 Level of Service	A
HCM 2000 Volume to Capacity ratio			0.50			
Actuated Cycle Length (s)			120.0		Sum of lost time (s)	9.0
Intersection Capacity Utilization			124.2%		ICU Level of Service	H
Analysis Period (min)			15			
c Critical Lane Group						

HCM Unsignalized Intersection Capacity Analysis
 141: US 29 (N) & Lewis and Clark U-Turn N

07/22/2021



Movement	EBL	EBR	NBL	NBT	SBT	SBR
Lane Configurations						
Traffic Volume (veh/h)	0	0	28	2758	0	0
Future Volume (Veh/h)	0	0	28	2758	0	0
Sign Control	Stop			Free	Free	
Grade	0%			0%	0%	
Peak Hour Factor	0.92	0.92	0.92	0.92	0.92	0.92
Hourly flow rate (vph)	0	0	30	2998	0	0
Pedestrians						
Lane Width (ft)						
Walking Speed (ft/s)						
Percent Blockage						
Right turn flare (veh)						
Median type				None	None	
Median storage (veh)						
Upstream signal (ft)	861					
pX, platoon unblocked	0.15					
vC, conflicting volume	1559	0	0			
vC1, stage 1 conf vol						
vC2, stage 2 conf vol						
vCu, unblocked vol	0	0	0			
tC, single (s)	6.8	6.9	4.1			
tC, 2 stage (s)						
tF (s)	3.5	3.3	2.2			
p0 queue free %	100	100	98			
cM capacity (veh/h)	146	1084	1622			
Direction, Lane #	NB 1	NB 2	NB 3			
Volume Total	30	1499	1499			
Volume Left	30	0	0			
Volume Right	0	0	0			
cSH	1622	1700	1700			
Volume to Capacity	0.02	0.88	0.88			
Queue Length 95th (ft)	1	0	0			
Control Delay (s)	7.3	0.0	0.0			
Lane LOS	A					
Approach Delay (s)	0.1					
Approach LOS						
Intersection Summary						
Average Delay			0.1			
Intersection Capacity Utilization			124.2%	ICU Level of Service	H	
Analysis Period (min)			15			

HCM Unsignalized Intersection Capacity Analysis
 142: US 29 (S)

07/22/2021



Movement	WBL	WBR	NBT	NBR	SBL	SBT
Lane Configurations					↘	↕↕
Traffic Volume (veh/h)	0	0	0	0	36	1507
Future Volume (Veh/h)	0	0	0	0	36	1507
Sign Control	Stop		Free		Free	
Grade	0%		0%		0%	
Peak Hour Factor	0.96	0.96	0.96	0.96	0.96	0.96
Hourly flow rate (vph)	0	0	0	0	38	1570
Pedestrians						
Lane Width (ft)						
Walking Speed (ft/s)						
Percent Blockage						
Right turn flare (veh)						
Median type	None			None		
Median storage (veh)						
Upstream signal (ft)	295			850		
pX, platoon unblocked	0.90					
vC, conflicting volume	861	0	0			
vC1, stage 1 conf vol						
vC2, stage 2 conf vol						
vCu, unblocked vol	628	0	0			
tC, single (s)	6.8	6.9	4.1			
tC, 2 stage (s)						
tF (s)	3.5	3.3	2.2			
p0 queue free %	100	100	98			
cM capacity (veh/h)	366	1084	1636			
Direction, Lane #	SB 1	SB 2	SB 3			
Volume Total	38	785	785			
Volume Left	38	0	0			
Volume Right	0	0	0			
cSH	1636	1700	1700			
Volume to Capacity	0.02	0.46	0.46			
Queue Length 95th (ft)	2	0	0			
Control Delay (s)	7.3	0.0	0.0			
Lane LOS	A					
Approach Delay (s)	0.2					
Approach LOS						
Intersection Summary						
Average Delay	0.2					
Intersection Capacity Utilization	52.6%		ICU Level of Service		A	
Analysis Period (min)	15					

Queues

143: North Pointe Access 2 & US 29 (N)

07/22/2021















Lane Group	EBT	WBR	NBT	NBR
Lane Group Flow (vph)	38	56	2873	71
v/c Ratio	0.31	0.29	0.92	0.05
Control Delay	59.7	45.1	4.8	0.6
Queue Delay	0.0	0.0	0.3	0.0
Total Delay	59.7	45.1	5.1	0.6
Queue Length 50th (ft)	29	18	247	1
Queue Length 95th (ft)	m0	40	m225	m1
Internal Link Dist (ft)	27		197	
Turn Bay Length (ft)				400
Base Capacity (vph)	285	429	3126	1407
Starvation Cap Reductn	0	0	38	0
Spillback Cap Reductn	0	0	0	0
Storage Cap Reductn	0	0	0	0
Reduced v/c Ratio	0.13	0.13	0.93	0.05

Intersection Summary

m Volume for 95th percentile queue is metered by upstream signal.

HCM Signalized Intersection Capacity Analysis
143: North Pointe Access 2 & US 29 (N)

07/22/2021

													
Movement	EBL	EBT	EBR	WBL	WBT	WBR	NBL	NBT	NBR	SBL	SBT	SBR	
Lane Configurations		↖				↗		↕	↗				
Traffic Volume (vph)	0	36	0	0	0	54	0	2758	68	0	0	0	
Future Volume (vph)	0	36	0	0	0	54	0	2758	68	0	0	0	
Ideal Flow (vphpl)	1900	1900	1900	1900	1900	1900	1900	1900	1900	1900	1900	1900	
Total Lost time (s)		4.5				4.5		4.5	4.5				
Lane Util. Factor		1.00				0.88		0.95	1.00				
Frt		1.00				0.85		1.00	0.85				
Flt Protected		1.00				1.00		1.00	1.00				
Satd. Flow (prot)		1900				2787		3539	1583				
Flt Permitted		1.00				1.00		1.00	1.00				
Satd. Flow (perm)		1900				2787		3539	1583				
Peak-hour factor, PHF	0.96	0.96	0.96	0.96	0.96	0.96	0.96	0.96	0.96	0.96	0.96	0.96	
Adj. Flow (vph)	0	38	0	0	0	56	0	2873	71	0	0	0	
RTOR Reduction (vph)	0	0	0	0	0	13	0	0	9	0	0	0	
Lane Group Flow (vph)	0	38	0	0	0	43	0	2873	62	0	0	0	
Heavy Vehicles (%)	0%	0%	0%	2%	2%	2%	0%	2%	2%	2%	2%	2%	
Turn Type		NA				Perm		NA	Perm				
Protected Phases		4						2					
Permitted Phases	4					8			2				
Actuated Green, G (s)		6.8				6.8		104.2	104.2				
Effective Green, g (s)		6.8				6.8		104.2	104.2				
Actuated g/C Ratio		0.06				0.06		0.87	0.87				
Clearance Time (s)		4.5				4.5		4.5	4.5				
Vehicle Extension (s)		3.0				3.0		3.0	3.0				
Lane Grp Cap (vph)		107				157		3073	1374				
v/s Ratio Prot		c0.02						c0.81					
v/s Ratio Perm						0.02			0.04				
v/c Ratio		0.36				0.27		0.93	0.04				
Uniform Delay, d1		54.5				54.2		5.5	1.1				
Progression Factor		1.03				1.00		0.50	1.50				
Incremental Delay, d2		1.8				0.9		0.7	0.0				
Delay (s)		57.7				55.2		3.5	1.6				
Level of Service		E				E		A	A				
Approach Delay (s)		57.7			55.2			3.5			0.0		
Approach LOS		E			E			A			A		
Intersection Summary													
HCM 2000 Control Delay			5.1									HCM 2000 Level of Service	A
HCM 2000 Volume to Capacity ratio			0.90										
Actuated Cycle Length (s)			120.0									Sum of lost time (s)	9.0
Intersection Capacity Utilization			128.9%									ICU Level of Service	H
Analysis Period (min)			15										
c	Critical Lane Group												

Queues

144: US 29 (S) & Lewis and Clark Dr

07/22/2021

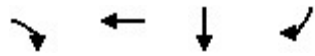

Lane Group	EBR	WBT	SBT	SBR
Lane Group Flow (vph)	255	22	1520	50
v/c Ratio	0.71	0.16	0.53	0.04
Control Delay	38.0	40.0	3.4	0.7
Queue Delay	0.0	0.0	0.0	0.0
Total Delay	38.0	40.0	3.4	0.7
Queue Length 50th (ft)	57	15	102	0
Queue Length 95th (ft)	103	m14	115	m4
Internal Link Dist (ft)		36	215	
Turn Bay Length (ft)				450
Base Capacity (vph)	588	263	2888	1300
Starvation Cap Reductn	0	0	0	0
Spillback Cap Reductn	0	0	0	0
Storage Cap Reductn	0	0	0	0
Reduced v/c Ratio	0.43	0.08	0.53	0.04

Intersection Summary

m Volume for 95th percentile queue is metered by upstream signal.

HCM Signalized Intersection Capacity Analysis
 144: US 29 (S) & Lewis and Clark Dr

07/22/2021

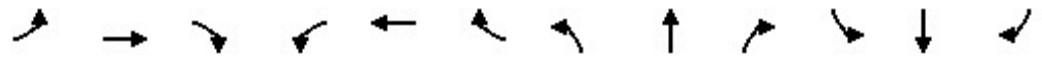

Movement	EBL	EBT	EBR	WBL	WBT	WBR	NBL	NBT	NBR	SBL	SBT	SBR
Lane Configurations			TT		T						TT	T
Traffic Volume (vph)	0	0	245	0	21	0	0	0	0	0	1459	48
Future Volume (vph)	0	0	245	0	21	0	0	0	0	0	1459	48
Ideal Flow (vphpl)	1900	1900	1900	1900	1900	1900	1900	1900	1900	1900	1900	1900
Total Lost time (s)			4.5		4.5						4.5	4.5
Lane Util. Factor			0.88		1.00						0.95	1.00
Frt			0.85		1.00						1.00	0.85
Flt Protected			1.00		1.00						1.00	1.00
Satd. Flow (prot)			2515		1348						3505	1568
Flt Permitted			1.00		1.00						1.00	1.00
Satd. Flow (perm)			2515		1348						3505	1568
Peak-hour factor, PHF	0.96	0.96	0.96	0.96	0.96	0.96	0.96	0.96	0.96	0.96	0.96	0.96
Adj. Flow (vph)	0	0	255	0	22	0	0	0	0	0	1520	50
RTOR Reduction (vph)	0	0	107	0	0	0	0	0	0	0	0	9
Lane Group Flow (vph)	0	0	148	0	22	0	0	0	0	0	1520	41
Heavy Vehicles (%)	0%	0%	13%	0%	41%	0%	2%	2%	2%	0%	3%	3%
Turn Type			Perm		NA						NA	Perm
Protected Phases					8						6	
Permitted Phases			4	8								6
Actuated Green, G (s)			12.1		12.1						98.9	98.9
Effective Green, g (s)			12.1		12.1						98.9	98.9
Actuated g/C Ratio			0.10		0.10						0.82	0.82
Clearance Time (s)			4.5		4.5						4.5	4.5
Vehicle Extension (s)			3.0		3.0						3.0	3.0
Lane Grp Cap (vph)			253		135						2888	1292
v/s Ratio Prot					0.02						c0.43	
v/s Ratio Perm			c0.06									0.03
v/c Ratio			0.58		0.16						0.53	0.03
Uniform Delay, d1			51.6		49.3						3.3	1.9
Progression Factor			1.00		0.84						0.75	0.81
Incremental Delay, d2			3.4		0.1						0.6	0.0
Delay (s)			55.0		41.6						3.1	1.6
Level of Service			D		D						A	A
Approach Delay (s)		55.0			41.6			0.0			3.0	
Approach LOS		D			D			A			A	
Intersection Summary												
HCM 2000 Control Delay			10.7		HCM 2000 Level of Service			B				
HCM 2000 Volume to Capacity ratio			0.53									
Actuated Cycle Length (s)			120.0		Sum of lost time (s)			9.0				
Intersection Capacity Utilization			133.5%		ICU Level of Service			H				
Analysis Period (min)			15									
c Critical Lane Group												

HCM Unsignalized Intersection Capacity Analysis
 145: US 29 (N)

07/22/2021



Movement	EBL	EBR	NBL	NBT	SBT	SBR
Lane Configurations						
Traffic Volume (veh/h)	0	0	21	2826	0	0
Future Volume (Veh/h)	0	0	21	2826	0	0
Sign Control	Stop			Free	Free	
Grade	0%			0%	0%	
Peak Hour Factor	0.96	0.96	0.96	0.96	0.96	0.96
Hourly flow rate (vph)	0	0	22	2944	0	0
Pedestrians						
Lane Width (ft)						
Walking Speed (ft/s)						
Percent Blockage						
Right turn flare (veh)						
Median type				None	None	
Median storage (veh)						
Upstream signal (ft)				918	277	
pX, platoon unblocked	0.23					
vC, conflicting volume	1516	0	0			
vC1, stage 1 conf vol						
vC2, stage 2 conf vol						
vCu, unblocked vol	0	0	0			
tC, single (s)	6.8	6.9	4.9			
tC, 2 stage (s)						
tF (s)	3.5	3.3	2.6			
p0 queue free %	100	100	98			
cM capacity (veh/h)	231	1084	1379			
Direction, Lane #	NB 1	NB 2	NB 3			
Volume Total	22	1472	1472			
Volume Left	22	0	0			
Volume Right	0	0	0			
cSH	1379	1700	1700			
Volume to Capacity	0.02	0.87	0.87			
Queue Length 95th (ft)	1	0	0			
Control Delay (s)	7.7	0.0	0.0			
Lane LOS	A					
Approach Delay (s)	0.1					
Approach LOS						
Intersection Summary						
Average Delay			0.1			
Intersection Capacity Utilization			137.9%	ICU Level of Service	H	
Analysis Period (min)			15			

HCM Unsignalized Intersection Capacity Analysis
 146: US 29 (S) & Lewis and Clark U-Turn S

07/22/2021



Movement	WBL	WBR	NBT	NBR	SBL	SBT
Lane Configurations					↘	↕↕
Traffic Volume (veh/h)	0	0	0	0	187	1491
Future Volume (Veh/h)	0	0	0	0	187	1491
Sign Control	Stop		Free		Free	
Grade	0%		0%		0%	
Peak Hour Factor	0.92	0.92	0.92	0.92	0.92	0.92
Hourly flow rate (vph)	0	0	0	0	203	1621
Pedestrians						
Lane Width (ft)						
Walking Speed (ft/s)						
Percent Blockage						
Right turn flare (veh)						
Median type	None			None		
Median storage (veh)						
Upstream signal (ft)	968			904		
pX, platoon unblocked	0.87					
vC, conflicting volume	1216	0	0			
vC1, stage 1 conf vol						
vC2, stage 2 conf vol						
vCu, unblocked vol	942	0	0			
tC, single (s)	6.8	6.9	4.4			
tC, 2 stage (s)						
tF (s)	3.5	3.3	2.3			
p0 queue free %	100	100	87			
cM capacity (veh/h)	197	1084	1545			
Direction, Lane #	SB 1	SB 2	SB 3			
Volume Total	203	810	810			
Volume Left	203	0	0			
Volume Right	0	0	0			
cSH	1545	1700	1700			
Volume to Capacity	0.13	0.48	0.48			
Queue Length 95th (ft)	11	0	0			
Control Delay (s)	7.7	0.0	0.0			
Lane LOS	A					
Approach Delay (s)	0.9					
Approach LOS						
Intersection Summary						
Average Delay	0.9					
Intersection Capacity Utilization	89.6%		ICU Level of Service		E	
Analysis Period (min)	15					

Queues

147: US 29 (N) & Lewis and Clark U-Turn S

07/22/2021

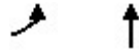

Lane Group	EBL	NBT
Lane Group Flow (vph)	203	2821
v/c Ratio	0.87	1.08
Control Delay	82.8	54.4
Queue Delay	0.0	8.6
Total Delay	82.8	63.0
Queue Length 50th (ft)	150	~1300
Queue Length 95th (ft)	#279	#1418
Internal Link Dist (ft)	29	889
Turn Bay Length (ft)		
Base Capacity (vph)	245	2612
Starvation Cap Reductn	0	0
Spillback Cap Reductn	0	71
Storage Cap Reductn	0	0
Reduced v/c Ratio	0.83	1.11

Intersection Summary

~ Volume exceeds capacity, queue is theoretically infinite.

Queue shown is maximum after two cycles.

95th percentile volume exceeds capacity, queue may be longer.

Queue shown is maximum after two cycles.

HCM Signalized Intersection Capacity Analysis
 147: US 29 (N) & Lewis and Clark U-Turn S

07/22/2021



Movement	EBL	EBR	NBL	NBT	SBT	SBR
Lane Configurations	↶			↕		
Traffic Volume (vph)	187	0	0	2595	0	0
Future Volume (vph)	187	0	0	2595	0	0
Ideal Flow (vphpl)	1900	1900	1900	1900	1900	1900
Total Lost time (s)	4.5			4.5		
Lane Util. Factor	1.00			0.95		
Frt	1.00			1.00		
Flt Protected	0.95			1.00		
Satd. Flow (prot)	1597			3343		
Flt Permitted	0.95			1.00		
Satd. Flow (perm)	1597			3343		
Peak-hour factor, PHF	0.92	0.92	0.92	0.92	0.92	0.92
Adj. Flow (vph)	203	0	0	2821	0	0
RTOR Reduction (vph)	6	0	0	0	0	0
Lane Group Flow (vph)	197	0	0	2821	0	0
Heavy Vehicles (%)	13%	0%	0%	8%	2%	2%
Turn Type	Prot			NA		
Protected Phases	4			2		
Permitted Phases						
Actuated Green, G (s)	17.2			93.8		
Effective Green, g (s)	17.2			93.8		
Actuated g/C Ratio	0.14			0.78		
Clearance Time (s)	4.5			4.5		
Vehicle Extension (s)	3.0			3.0		
Lane Grp Cap (vph)	228			2613		
v/s Ratio Prot	c0.12			c0.84		
v/s Ratio Perm						
v/c Ratio	0.86			1.08		
Uniform Delay, d1	50.3			13.1		
Progression Factor	1.10			0.74		
Incremental Delay, d2	24.5			41.5		
Delay (s)	79.8			51.1		
Level of Service	E			D		
Approach Delay (s)	79.8			51.1	0.0	
Approach LOS	E			D	A	
Intersection Summary						
HCM 2000 Control Delay			53.0		HCM 2000 Level of Service	D
HCM 2000 Volume to Capacity ratio			1.05			
Actuated Cycle Length (s)			120.0		Sum of lost time (s)	9.0
Intersection Capacity Utilization			94.5%		ICU Level of Service	F
Analysis Period (min)			15			
c Critical Lane Group						

Queues

150: US 29 (S) & U-Turn Access

07/22/2021

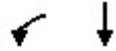

Lane Group	WBL	SBT
Lane Group Flow (vph)	23	1705
v/c Ratio	0.19	0.53
Control Delay	5.7	1.5
Queue Delay	0.0	0.0
Total Delay	5.7	1.5
Queue Length 50th (ft)	0	91
Queue Length 95th (ft)	m0	104
Internal Link Dist (ft)	22	888
Turn Bay Length (ft)		
Base Capacity (vph)	271	3219
Starvation Cap Reductn	0	0
Spillback Cap Reductn	0	0
Storage Cap Reductn	0	0
Reduced v/c Ratio	0.08	0.53

Intersection Summary

m Volume for 95th percentile queue is metered by upstream signal.

HCM Signalized Intersection Capacity Analysis
 150: US 29 (S) & U-Turn Access

07/22/2021



Movement	WBL	WBR	NBT	NBR	SBL	SBT
Lane Configurations	↶					↷↷
Traffic Volume (vph)	21	0	0	0	0	1586
Future Volume (vph)	21	0	0	0	0	1586
Ideal Flow (vphpl)	1900	1900	1900	1900	1900	1900
Total Lost time (s)	4.5					4.5
Lane Util. Factor	1.00					0.95
Frt	1.00					1.00
Flt Protected	0.95					1.00
Satd. Flow (prot)	1456					3471
Flt Permitted	0.95					1.00
Satd. Flow (perm)	1456					3471
Peak-hour factor, PHF	0.93	0.93	0.93	0.93	0.93	0.93
Adj. Flow (vph)	23	0	0	0	0	1705
RTOR Reduction (vph)	22	0	0	0	0	0
Lane Group Flow (vph)	1	0	0	0	0	1705
Heavy Vehicles (%)	24%	0%	0%	0%	0%	4%
Turn Type	Prot					NA
Protected Phases	8					6
Permitted Phases						
Actuated Green, G (s)	3.3					107.7
Effective Green, g (s)	3.3					107.7
Actuated g/C Ratio	0.03					0.90
Clearance Time (s)	4.5					4.5
Vehicle Extension (s)	3.0					3.0
Lane Grp Cap (vph)	40					3115
v/s Ratio Prot	c0.00					c0.49
v/s Ratio Perm						
v/c Ratio	0.02					0.55
Uniform Delay, d1	56.8					1.2
Progression Factor	7.47					0.75
Incremental Delay, d2	0.1					0.6
Delay (s)	424.4					1.6
Level of Service	F					A
Approach Delay (s)	424.4		0.0			1.6
Approach LOS	F		A			A
Intersection Summary						
HCM 2000 Control Delay			7.2		HCM 2000 Level of Service	A
HCM 2000 Volume to Capacity ratio			0.53			
Actuated Cycle Length (s)			120.0		Sum of lost time (s)	9.0
Intersection Capacity Utilization			123.5%		ICU Level of Service	H
Analysis Period (min)			15			
c Critical Lane Group						

HCM Unsignalized Intersection Capacity Analysis
 151: US 29 (N) & U-Turn Access

07/22/2021



Movement	EBL	EBR	NBL	NBT	SBT	SBR
Lane Configurations			↔↔	↑↑		
Traffic Volume (veh/h)	0	0	21	2625	0	0
Future Volume (Veh/h)	0	0	21	2625	0	0
Sign Control	Stop			Free	Free	
Grade	0%			0%	0%	
Peak Hour Factor	0.93	0.93	0.93	0.93	0.93	0.93
Hourly flow rate (vph)	0	0	23	2823	0	0
Pedestrians						
Lane Width (ft)						
Walking Speed (ft/s)						
Percent Blockage						
Right turn flare (veh)						
Median type				None	None	
Median storage (veh)						
Upstream signal (ft)				522	969	
pX, platoon unblocked	0.17					
vC, conflicting volume	1458	0	0			
vC1, stage 1 conf vol						
vC2, stage 2 conf vol						
vCu, unblocked vol	0	0	0			
tC, single (s)	6.8	6.9	4.6			
tC, 2 stage (s)						
tF (s)	3.5	3.3	2.4			
p0 queue free %	100	100	98			
cM capacity (veh/h)	172	1091	1475			
Direction, Lane #	NB 1	NB 2	NB 3	NB 4		
Volume Total	12	12	1412	1412		
Volume Left	12	12	0	0		
Volume Right	0	0	0	0		
cSH	1475	1475	1700	1700		
Volume to Capacity	0.02	0.02	0.83	0.83		
Queue Length 95th (ft)	1	1	0	0		
Control Delay (s)	7.5	7.5	0.0	0.0		
Lane LOS	A	A				
Approach Delay (s)	0.1					
Approach LOS						
Intersection Summary						
Average Delay	0.1					
Intersection Capacity Utilization	123.5%		ICU Level of Service	H		
Analysis Period (min)	15					

HCM Unsignalized Intersection Capacity Analysis
 160: Northside Dr E & US 29 (S)

07/22/2021



Movement	WBL	WBR	NBT	NBR	SBL	SBT
Lane Configurations					↖ ↗	↖ ↗
Traffic Volume (veh/h)	0	0	0	0	47	1535
Future Volume (Veh/h)	0	0	0	0	47	1535
Sign Control	Stop		Free		Free	
Grade	0%		0%		0%	
Peak Hour Factor	0.97	0.97	0.97	0.97	0.97	0.97
Hourly flow rate (vph)	0	0	0	0	48	1582
Pedestrians						
Lane Width (ft)						
Walking Speed (ft/s)						
Percent Blockage						
Right turn flare (veh)						
Median type	None			None		
Median storage (veh)						
Upstream signal (ft)						518
pX, platoon unblocked	0.90					
vC, conflicting volume	887	0	0			
vC1, stage 1 conf vol						
vC2, stage 2 conf vol						
vCu, unblocked vol	641	0	0			
tC, single (s)	6.8	6.9	4.1			
tC, 2 stage (s)						
tF (s)	3.5	3.3	2.2			
p0 queue free %	100	100	97			
cM capacity (veh/h)	358	1091	1636			
Direction, Lane #	SB 1	SB 2	SB 3	SB 4		
Volume Total	24	24	791	791		
Volume Left	24	24	0	0		
Volume Right	0	0	0	0		
cSH	1636	1636	1700	1700		
Volume to Capacity	0.03	0.03	0.47	0.47		
Queue Length 95th (ft)	2	2	0	0		
Control Delay (s)	7.3	7.3	0.0	0.0		
Lane LOS	A	A				
Approach Delay (s)	0.2					
Approach LOS						
Intersection Summary						
Average Delay	0.2					
Intersection Capacity Utilization	55.5%		ICU Level of Service		B	
Analysis Period (min)	15					

Queues

161: US 29 (N) & Northside Dr E/North Pointe Access 1

07/22/2021





















Lane Group	EBT	WBR	NBT	NBR
Lane Group Flow (vph)	48	131	2407	193
v/c Ratio	0.16	0.52	0.82	0.14
Control Delay	56.8	48.2	8.2	0.5
Queue Delay	0.0	0.0	0.0	0.0
Total Delay	56.8	48.2	8.2	0.5
Queue Length 50th (ft)	20	43	364	0
Queue Length 95th (ft)	m37	77	571	11
Internal Link Dist (ft)	14		174	
Turn Bay Length (ft)				300
Base Capacity (vph)	541	437	2953	1391
Starvation Cap Reductn	0	0	0	0
Spillback Cap Reductn	0	0	0	0
Storage Cap Reductn	0	0	0	0
Reduced v/c Ratio	0.09	0.30	0.82	0.14

Intersection Summary

m Volume for 95th percentile queue is metered by upstream signal.

















HCM Signalized Intersection Capacity Analysis
 161: US 29 (N) & Northside Dr E/North Pointe Access 1

07/22/2021

												
Movement	EBL	EBT	EBR	WBL	WBT	WBR	NBL	NBT	NBR	SBL	SBT	SBR
Lane Configurations		 				 		 				
Traffic Volume (vph)	0	47	0	0	0	127	0	2335	187	0	0	0
Future Volume (vph)	0	47	0	0	0	127	0	2335	187	0	0	0
Ideal Flow (vphpl)	1900	1900	1900	1900	1900	1900	1900	1900	1900	1900	1900	1900
Total Lost time (s)		4.5				4.5		4.5	4.5			
Lane Util. Factor		0.95				0.88		0.95	1.00			
Frt		1.00				0.85		1.00	0.85			
Flt Protected		1.00				1.00		1.00	1.00			
Satd. Flow (prot)		3610				2760		3505	1615			
Flt Permitted		1.00				1.00		1.00	1.00			
Satd. Flow (perm)		3610				2760		3505	1615			
Peak-hour factor, PHF	0.97	0.97	0.97	0.97	0.97	0.97	0.97	0.97	0.97	0.97	0.97	0.97
Adj. Flow (vph)	0	48	0	0	0	131	0	2407	193	0	0	0
RTOR Reduction (vph)	0	0	0	0	0	26	0	0	30	0	0	0
Lane Group Flow (vph)	0	48	0	0	0	105	0	2407	163	0	0	0
Heavy Vehicles (%)	0%	0%	0%	0%	0%	3%	0%	3%	0%	0%	0%	0%
Turn Type		NA				Perm		NA	Perm			
Protected Phases		4						2				
Permitted Phases	4					8			2			
Actuated Green, G (s)		9.9				9.9		101.1	101.1			
Effective Green, g (s)		9.9				9.9		101.1	101.1			
Actuated g/C Ratio		0.08				0.08		0.84	0.84			
Clearance Time (s)		4.5				4.5		4.5	4.5			
Vehicle Extension (s)		3.0				3.0		3.0	3.0			
Lane Grp Cap (vph)		297				227		2952	1360			
v/s Ratio Prot		0.01						c0.69				
v/s Ratio Perm						c0.04			0.10			
v/c Ratio		0.16				0.46		0.82	0.12			
Uniform Delay, d1		51.2				52.5		4.8	1.7			
Progression Factor		1.12				1.00		1.00	1.00			
Incremental Delay, d2		0.2				1.5		2.6	0.2			
Delay (s)		57.3				54.0		7.4	1.8			
Level of Service		E				D		A	A			
Approach Delay (s)		57.3			54.0			7.0			0.0	
Approach LOS		E			D			A			A	
Intersection Summary												
HCM 2000 Control Delay			10.0				HCM 2000 Level of Service		B			
HCM 2000 Volume to Capacity ratio			0.78									
Actuated Cycle Length (s)			120.0				Sum of lost time (s)		9.0			
Intersection Capacity Utilization			120.3%				ICU Level of Service		H			
Analysis Period (min)			15									
c Critical Lane Group												

HCM Unsignalized Intersection Capacity Analysis
 162: US 29 (S) & Northside Dr W

07/22/2021

												
Movement	EBL	EBT	EBR	WBL	WBT	WBR	NBL	NBT	NBR	SBL	SBT	SBR
Lane Configurations											 	
Traffic Volume (veh/h)	0	0	21	0	6	0	0	0	0	0	1530	5
Future Volume (Veh/h)	0	0	21	0	6	0	0	0	0	0	1530	5
Sign Control		Stop			Stop			Free			Free	
Grade		0%			0%			0%			0%	
Peak Hour Factor	0.97	0.97	0.97	0.97	0.97	0.97	0.97	0.97	0.97	0.97	0.97	0.97
Hourly flow rate (vph)	0	0	22	0	6	0	0	0	0	0	1577	5
Pedestrians												
Lane Width (ft)												
Walking Speed (ft/s)												
Percent Blockage												
Right turn flare (veh)												
Median type								None			None	
Median storage (veh)												
Upstream signal (ft)											769	
pX, platoon unblocked	0.89	0.89	0.89	0.89	0.89		0.89					
vC, conflicting volume	1580	1577	788	810	1582	0	1582			0		
vC1, stage 1 conf vol												
vC2, stage 2 conf vol												
vCu, unblocked vol	1413	1410	528	553	1415	0	1415			0		
tC, single (s)	7.5	6.5	7.7	7.5	6.5	6.9	4.1			4.1		
tC, 2 stage (s)												
tF (s)	3.5	4.0	3.7	3.5	4.0	3.3	2.2			2.2		
p0 queue free %	100	100	94	100	95	100	100			100		
cM capacity (veh/h)	86	125	364	353	122	1091	436			1636		
Direction, Lane #	EB 1	WB 1	SB 1	SB 2	SB 3							
Volume Total	22	6	788	788	5							
Volume Left	0	0	0	0	0							
Volume Right	22	0	0	0	5							
cSH	364	122	1700	1700	1700							
Volume to Capacity	0.06	0.05	0.46	0.46	0.00							
Queue Length 95th (ft)	5	4	0	0	0							
Control Delay (s)	15.5	36.0	0.0	0.0	0.0							
Lane LOS	C	E										
Approach Delay (s)	15.5	36.0	0.0									
Approach LOS	C	E										
Intersection Summary												
Average Delay			0.3									
Intersection Capacity Utilization			73.0%		ICU Level of Service					D		
Analysis Period (min)			15									

HCM Unsignalized Intersection Capacity Analysis
 163: US 29 (N) & Northside Dr W

07/22/2021



Movement	EBL	EBR	NBL	NBT	SBT	SBR
Lane Configurations						
Traffic Volume (veh/h)	0	0	6	2522	0	0
Future Volume (Veh/h)	0	0	6	2522	0	0
Sign Control	Stop			Free	Free	
Grade	0%			0%	0%	
Peak Hour Factor	0.97	0.97	0.97	0.97	0.97	0.97
Hourly flow rate (vph)	0	0	6	2600	0	0
Pedestrians						
Lane Width (ft)						
Walking Speed (ft/s)						
Percent Blockage						
Right turn flare (veh)						
Median type				None	None	
Median storage (veh)						
Upstream signal (ft)				254		
pX, platoon unblocked						
vC, conflicting volume	1312	0	0			
vC1, stage 1 conf vol						
vC2, stage 2 conf vol						
vCu, unblocked vol	1312	0	0			
tC, single (s)	6.8	6.9	4.1			
tC, 2 stage (s)						
tF (s)	3.5	3.3	2.2			
p0 queue free %	100	100	100			
cM capacity (veh/h)	152	1091	1636			
Direction, Lane #	NB 1	NB 2	NB 3			
Volume Total	6	1300	1300			
Volume Left	6	0	0			
Volume Right	0	0	0			
cSH	1636	1700	1700			
Volume to Capacity	0.00	0.76	0.76			
Queue Length 95th (ft)	0	0	0			
Control Delay (s)	7.2	0.0	0.0			
Lane LOS	A					
Approach Delay (s)	0.0					
Approach LOS						
Intersection Summary						
Average Delay	0.0					
Intersection Capacity Utilization	73.0%			ICU Level of Service	D	
Analysis Period (min)	15					

HCM Unsignalized Intersection Capacity Analysis
 170: Airport Acres Rd (North) E & US 29 (S)

07/22/2021



Movement	WBL	WBR	NBT	NBR	SBL	SBT
Lane Configurations					↘	↕↕
Traffic Volume (veh/h)	0	0	0	0	9	1583
Future Volume (Veh/h)	0	0	0	0	9	1583
Sign Control	Stop		Free		Free	
Grade	0%		0%		0%	
Peak Hour Factor	0.97	0.97	0.97	0.97	0.97	0.97
Hourly flow rate (vph)	0	0	0	0	9	1632
Pedestrians						
Lane Width (ft)						
Walking Speed (ft/s)						
Percent Blockage						
Right turn flare (veh)						
Median type	None			None		
Median storage (veh)						
Upstream signal (ft)						
pX, platoon unblocked						
vC, conflicting volume	834	0			0	
vC1, stage 1 conf vol						
vC2, stage 2 conf vol						
vCu, unblocked vol	834	0			0	
tC, single (s)	6.8	6.9			4.1	
tC, 2 stage (s)						
tF (s)	3.5	3.3			2.2	
p0 queue free %	100	100			99	
cM capacity (veh/h)	309	1091			1636	
Direction, Lane #	SB 1	SB 2	SB 3			
Volume Total	9	816	816			
Volume Left	9	0	0			
Volume Right	0	0	0			
cSH	1636	1700	1700			
Volume to Capacity	0.01	0.48	0.48			
Queue Length 95th (ft)	0	0	0			
Control Delay (s)	7.2	0.0	0.0			
Lane LOS	A					
Approach Delay (s)	0.0					
Approach LOS						
Intersection Summary						
Average Delay	0.0					
Intersection Capacity Utilization	80.4%		ICU Level of Service		D	
Analysis Period (min)	15					

HCM Unsignalized Intersection Capacity Analysis
 171: Airport Acres Rd (North) E & US 29 (N)

















07/22/2021



Movement	EBL	EBR	NBL	NBT	SBT	SBR
Lane Configurations	↵			↑↑		
Traffic Volume (veh/h)	9	0	0	2545	0	0
Future Volume (Veh/h)	9	0	0	2545	0	0
Sign Control	Stop			Free	Free	
Grade	0%			0%	0%	
Peak Hour Factor	0.97	0.97	0.97	0.97	0.97	0.97
Hourly flow rate (vph)	9	0	0	2624	0	0
Pedestrians						
Lane Width (ft)						
Walking Speed (ft/s)						
Percent Blockage						
Right turn flare (veh)						
Median type				None	None	
Median storage (veh)						
Upstream signal (ft)						
pX, platoon unblocked						
vC, conflicting volume	1312	0	0			
vC1, stage 1 conf vol						
vC2, stage 2 conf vol						
vCu, unblocked vol	1312	0	0			
tC, single (s)	6.8	6.9	4.1			
tC, 2 stage (s)						
tF (s)	3.5	3.3	2.2			
p0 queue free %	94	100	100			
cM capacity (veh/h)	150	1091	1636			
Direction, Lane #	EB 1	NB 1	NB 2			
Volume Total	9	1312	1312			
Volume Left	9	0	0			
Volume Right	0	0	0			
cSH	150	1700	1700			
Volume to Capacity	0.06	0.77	0.77			
Queue Length 95th (ft)	5	0	0			
Control Delay (s)	30.5	0.0	0.0			
Lane LOS	D					
Approach Delay (s)	30.5	0.0				
Approach LOS	D					
Intersection Summary						
Average Delay			0.1			
Intersection Capacity Utilization			80.4%	ICU Level of Service	D	
Analysis Period (min)			15			

HCM Unsignalized Intersection Capacity Analysis
 172: US 29 (S) & Airport Acres Rd (North) W

07/22/2021

												
Movement	EBL	EBT	EBR	WBL	WBT	WBR	NBL	NBT	NBR	SBL	SBT	SBR
Lane Configurations												
Traffic Volume (veh/h)	0	0	5	0	9	0	0	0	0	0	1578	5
Future Volume (Veh/h)	0	0	5	0	9	0	0	0	0	0	1578	5
Sign Control		Stop			Stop			Free			Free	
Grade		0%			0%			0%			0%	
Peak Hour Factor	0.97	0.97	0.97	0.97	0.97	0.97	0.97	0.97	0.97	0.97	0.97	0.97
Hourly flow rate (vph)	0	0	5	0	9	0	0	0	0	0	1627	5
Pedestrians												
Lane Width (ft)												
Walking Speed (ft/s)												
Percent Blockage												
Right turn flare (veh)												
Median type								None			None	
Median storage (veh)												
Upstream signal (ft)												
pX, platoon unblocked												
vC, conflicting volume	1634	1630	816	818	1632	0	1632			0		
vC1, stage 1 conf vol												
vC2, stage 2 conf vol												
vCu, unblocked vol	1634	1630	816	818	1632	0	1632			0		
tC, single (s)	7.5	6.5	6.9	7.5	6.5	6.9	4.1			4.1		
tC, 2 stage (s)												
tF (s)	3.5	4.0	3.3	3.5	4.0	3.3	2.2			2.2		
p0 queue free %	100	100	98	100	91	100	100			100		
cM capacity (veh/h)	64	103	324	267	102	1091	403			1636		
Direction, Lane #	EB 1	WB 1	SB 1	SB 2								
Volume Total	5	9	1085	547								
Volume Left	0	0	0	0								
Volume Right	5	0	0	5								
cSH	324	102	1700	1700								
Volume to Capacity	0.02	0.09	0.64	0.32								
Queue Length 95th (ft)	1	7	0	0								
Control Delay (s)	16.3	43.5	0.0	0.0								
Lane LOS	C	E										
Approach Delay (s)	16.3	43.5	0.0									
Approach LOS	C	E										
Intersection Summary												
Average Delay			0.3									
Intersection Capacity Utilization			125.6%		ICU Level of Service					H		
Analysis Period (min)			15									

HCM Unsignalized Intersection Capacity Analysis
 173: US 29 (N)

07/22/2021



Movement	EBL	EBR	NBL	NBT	SBT	SBR
Lane Configurations						
Traffic Volume (veh/h)	0	0	9	2545	0	0
Future Volume (Veh/h)	0	0	9	2545	0	0
Sign Control	Stop			Free	Free	
Grade	0%			0%	0%	
Peak Hour Factor	0.97	0.97	0.97	0.97	0.97	0.97
Hourly flow rate (vph)	0	0	9	2624	0	0
Pedestrians						
Lane Width (ft)						
Walking Speed (ft/s)						
Percent Blockage						
Right turn flare (veh)						
Median type			None	None		
Median storage (veh)						
Upstream signal (ft)						
pX, platoon unblocked						
vC, conflicting volume	1330	0	0			
vC1, stage 1 conf vol						
vC2, stage 2 conf vol						
vCu, unblocked vol	1330	0	0			
tC, single (s)	6.8	6.9	4.1			
tC, 2 stage (s)						
tF (s)	3.5	3.3	2.2			
p0 queue free %	100	100	99			
cM capacity (veh/h)	148	1091	1636			
Direction, Lane #	NB 1	NB 2	NB 3			
Volume Total	9	1312	1312			
Volume Left	9	0	0			
Volume Right	0	0	0			
cSH	1636	1700	1700			
Volume to Capacity	0.01	0.77	0.77			
Queue Length 95th (ft)	0	0	0			
Control Delay (s)	7.2	0.0	0.0			
Lane LOS	A					
Approach Delay (s)	0.0					
Approach LOS						
Intersection Summary						
Average Delay			0.0			
Intersection Capacity Utilization			127.5%	ICU Level of Service	H	
Analysis Period (min)			15			